



GIRARD SUDRON

PARIS 1894



130 | 1894
ANS | 2024/25

À L'ORIGINE DE LA LUMIÈRE.

ACCESSOIRES



GIRARD SUDRON

PARIS 1894



Et la lumière fut design **GIRARD SUDRON**

*La Maison Girard Sudron s'est invitée dans les intérieurs depuis 1894.
La marque a traversé les années, les époques, en restant toujours aussi
innovante qu'à ses débuts et en se réinventant pour rester dans l'ère du temps.
Ses piliers ? **Qualité, service et passion de la lumière.***

130 ANS DE MODERNITÉ

Impossible de passer à côté de cette marque historique. Spécialiste des solutions d'éclairage premium haut de gamme et originales, **Girard Sudron** a toujours été en avance sur son temps en initiant les tendances et en intégrant les meilleures technologies dans des produits à l'esthétique soignée. Au début de l'éclairage électrique, c'est la marque qui équipe les lustres à chandelles, en mettant au point un système de fourreau combiné à une bougie lumineuse qui permet de recourir à ce nouveau mode d'éclairage tout en conservant un style traditionnel. La marque continue ensuite à écrire son histoire en s'imposant, déjà, dans le créatif.

L'après-guerre voit la révolution de **Girard Sudron** en utilisant une nouvelle technique de soufflage de verre à "*pointe légèrement recourbée*" devenu emblématique. Les modèles restent toujours d'actualité aujourd'hui. Vous ne serez pas les premiers à succomber !

*Les lampes **Girard Sudron** éclairent des lieux prestigieux comme l'Élysée, l'Hôtel de Ville de Lyon, le Château de Versailles, le Domaine National de Chambord, l'Opéra Garnier, des grands palaces dans le monde et des commerces de luxe...*



Notre culot en guise de sceau

Aussi prestigieux que le saphir présent dans nos LED, nous amplifions l'élégance jusqu'à la base de nos ampoules, les rendant lumineuses aussi bien éteintes qu'allumées. Ancré dans notre ADN depuis tant d'années, de la flamme grand siècle à l'Edison en passant par notre ampoule géante de 600mm de diamètre, toutes nos ampoules sont dotées d'un culot doré unique. Couleur du soleil synonyme de signature, notre esthétique ne s'arrête pas là. De nos finitions claires, ambrées ou smokey nous portons une attention particulière à toutes nos ampoules dans leur intégralité.

Pourquoi choisir la led ?

Ces dernières années, le développement durable est devenu l'une des priorités de notre société contemporaine. C'est pourquoi nous déployons tous les efforts possibles pour produire en protégeant la nature ainsi que votre consommation. En utilisant notre éclairage LED, vous pourrez réduire considérablement votre empreinte écologique.

Élué également par le grand public depuis plusieurs années, son achat est plus écologique puisque sa durée de vie est décuplée par rapport à une ampoule éco-halogène bientôt interdite sur le marché européen. Moins gourmande qu'une ampoule à incandescence, elle possède néanmoins une intensité lumineuse allant jusqu'à 100 lumens par watt.

Petit tour d'horizon des avantages de la LED

- Des ampoules sans mercure, ni gaz polluant.
- Une durée de vie largement supérieure aux autres sources lumineuses.
- Un éclairage au niveau maximal dès l'allumage et non de manière progressive.
- Des sources lumineuses moins énergivores.
- Peu de besoin de maintenance du fait de sa longévité.
- Pas de dégagement de chaleur.

CULOTS

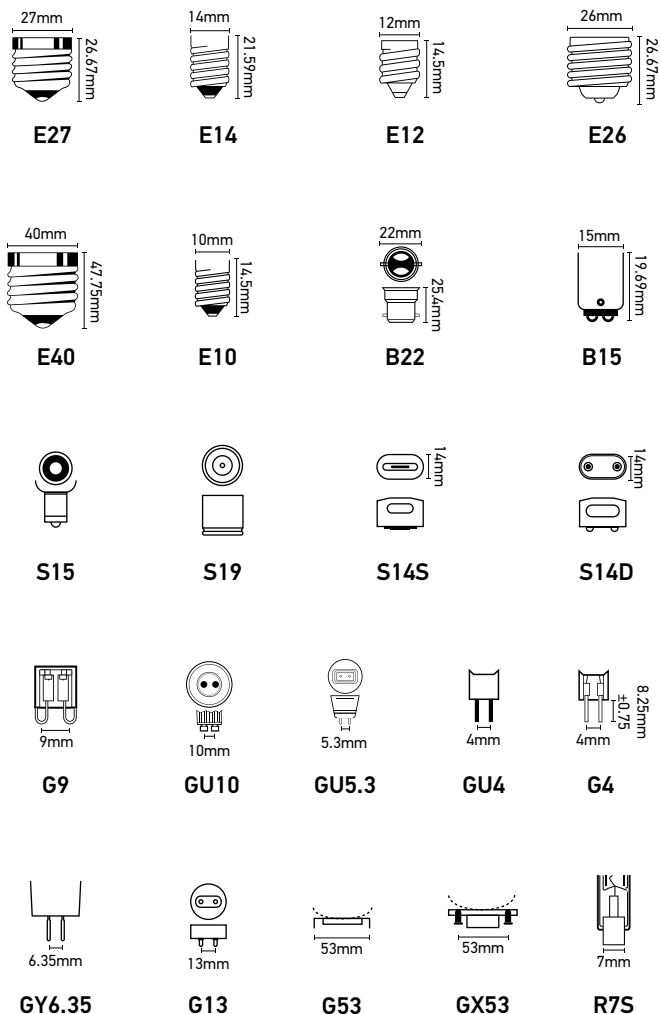

FORMES

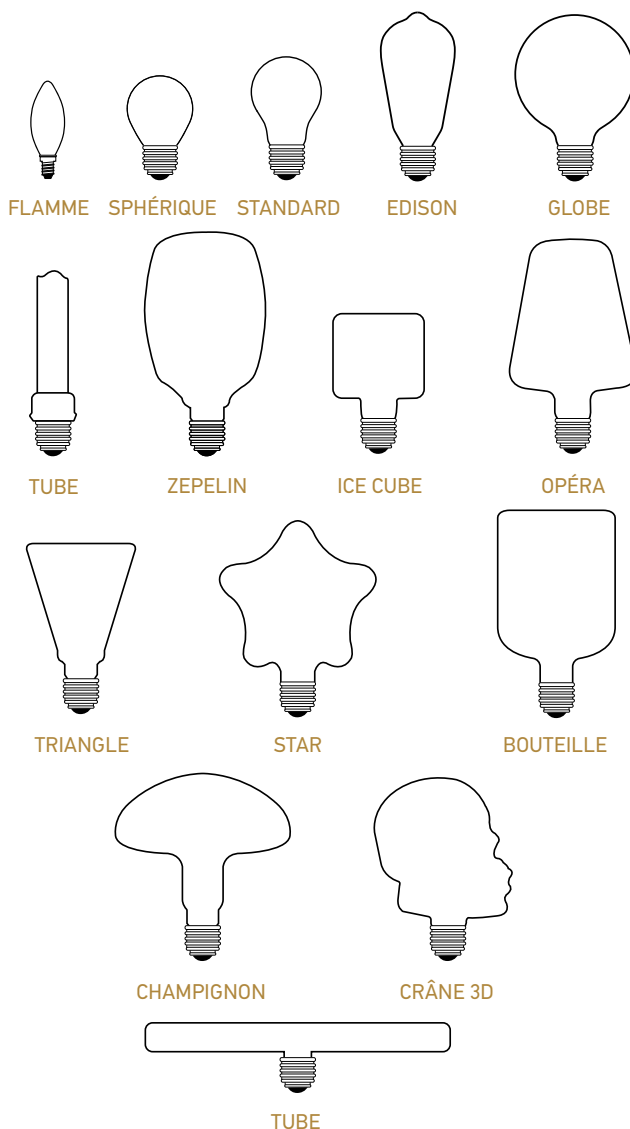

PUISSANCE

| Eco-Halogène | LED | Lumens |
|--------------|---------|---------|
| = 19W | =2-3W | =249lm |
| = 30W | =4-5W | =470lm |
| = 46W | =6-9W | =806lm |
| = 57W | =8-12W | =1055lm |
| = 72W | =10-15W | =1521lm |

TEMPÉRATURE DE COULEUR

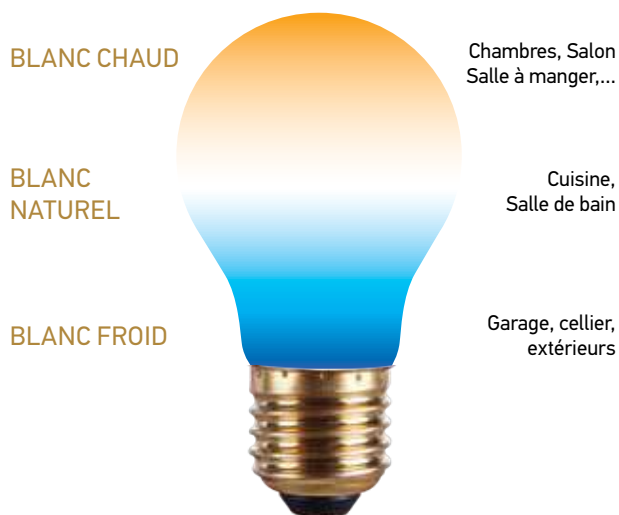

SYMBOLES

TENSION

























V. AC
110-240V
50/60Hz

V. AC
220-240V
50/60Hz

V. AC/DC
12V

V. DC
12V

V. DC
24V

| | | | |
|---|--|--|---|
| Ref. | RÉFÉRENCE |  | CLASSE 1 |
| W | PUISSANCE |  | CLASSE 2 |
|  | CULOT |  | CLASSE 3 |
| K | KELVIN |  | POIDS |
| lm | LUMENS |  | MARQUE DU DRIVER |
| mA | COURANT |  | ENTRÉE / SORTIE |
|  | NON UTILISABLE AVEC UN VARIATEUR |  | SACHET |
|  | UTILISATION POSSIBLE AVEC UN VARIATEUR |  | CONDITIONNEMENT |
|  | DURÉE DE VIE |  | FINITION |
|  | ECLAIRAGE INSTANTANÉ <1,0 SEC | T°C | TEMPÉRATURE DE FONCTIONNEMENT |
|  | ANGLE DE DIFFUSION | 850° 650° | TEST AU FIL INCANDESCENT |
|  | CYCLE DE COMMUTATION | UGR | ÉVALUATION DE L'ÉBLOUISSEMENT |
|  | INDICE DE PROTECTION | cULus | CURUS |
| ENERGY  | ECHELLE ÉNERGÉTIQUE |  | UL |
|  Years | GARANTIE |  Bluetooth | BLUETOOTH |
| Ra | INDICE DE RENDU DES COULEURS |  | SUISSE |
| IK | INDICE DE PROTECTION CONTRE LES CHOCS MÉCANIQUES | CE | NORME CE " CONFORMITÉ EUROPÉENNE " |
| PF | FACTEUR DE PUISSANCE |  | NORME ROHS "RESTRICTION DE L'UTILISATION DE CERTAINES SUBSTANCES DANGEREUSES DANS LES ÉQUIPEMENTS ÉLECTRIQUES ET ÉLECTRONIQUES" |
| HG | QUANTITÉ DE MERCURE |  | CE LUMINAIRE EST COMPATIBLE AVEC DES SOURCES LUMINEUSES DE CLASSES ÉNERGÉTIQUES |
|  | ENCASTREMENT | | |



GIRARD SUDRON

PARIS 1894

Indispensable à votre décoration

Que vous soyez restaurateurs de lustres voulant conserver toute la qualité et le choix des matières d'autrefois, ou créatif à l'imagination débordante voulant s'adapter aux nouvelles consommations des générations futures, vous trouverez au sein de ce chapitre tous les accessoires lumineux dont vous avez besoin pour redonner vie à vos idées.

Du style vintage, industriel ou design en passant par les matières brutes comme le béton ou nobles comme le laiton, nous vous proposons un large choix d'articles aux finitions subtiles et élégantes pour composer toutes sortes de luminaires ou restaurer d'anciennes pièces uniques chères aux yeux de leurs propriétaires.

Vous trouverez dans ce chapitre l'indispensable pour faire de votre lumière l'élément-clé de votre déco. Aussi vital que l'air que nous respirons, *personnalisez* vos suspensions, *transformez* vos anciennes lampes à pétrole ou jouez tout simplement à *détourner les objets*.

ACCESSOIRES

| | |
|-----------------------------------|-----|
| NOUVEAUTÉS..... | 12 |
| LAMPES À POSER | 20 |
| ABAT-JOUR DECO..... | 40 |
| APPLIQUES | 48 |
| SUSPENSIONS DECO..... | 54 |
| ROSACES & PAVILLONS DECO | 72 |
| PAVILLONS TECHNIQUES..... | 84 |
| DOUILLES DECO..... | 88 |
| DOUILLES TECHNIQUES | 100 |
| CÂBLES DECO | 128 |
| CÂBLES PRÉ-MONTÉS | 142 |
| FICHES | 150 |
| INTERRUPTEURS..... | 154 |
| VARIATEURS | 162 |
| PRISES ET MULTIPRISES | 166 |
| COMPOSANTS LUSTRERIE | 172 |
| VERRERIES & ACCESSOIRES | 210 |
| FOURREAUX & BOUGIES..... | 228 |
| RÉCAPITULATIF DES RÉFÉRENCES..... | 238 |

NOUVEAUTÉS





ACCESSOIRES

SUSPENSIONS E27



241607 | 241608

Section du câble | 2 x 0.75mm²
 Type de câble | H03VV-F
 Matériau
 • Rosace | Marbre
 • Douille | Marbre
 • Câble | Textile

60W
 Max.









PAVILLON
300706

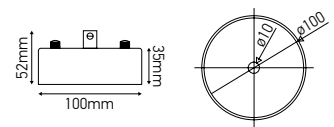

Sortie simple
Matériel : bois



NOUVEAUTÉS



DOUILLE E27
300630

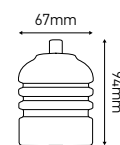

DOUILLE ACIER

DOUILLE E27
AVEC INTERRUPTEUR



300628 | 300629

Matériau
• Intérieur | plastique
• Extérieur | aluminium

60W
Max.





200606 | 200607

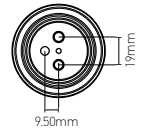
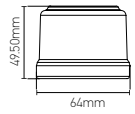

NOUVEAUTÉS



16A
250V





LAMPES À POSER

| | |
|---------------------------|----|
| SUPPORTS DE LAMPE | 22 |
| LAMPADAIRE EN BOIS | 27 |
| LUMINAIRES SUR PIED | 28 |
| LAMPE À POSER | 31 |







174151 | 174150



V. AC
220-240V
HG = 0,0mg

| Ref. | W |  |  | Dim. mm | PCB Inner | PCB Outer |
|---------------|---------|---|---|-------------|--------------|--------------|
| 174151 | 40 max. | E27 | blanc | Ø98 x 90 mm | - | 9 |
| 174150 | 40 max. | E27 | noir | Ø98 x 90 mm | - | 9 |

► Source lumineuse non incluse



174152 | 174153 | 174154



V. AC
220-240V
HG = 0,0mg

| Ref. | W | ⚡ | 💡 | Dim. mm | PCB Inner | PCB Outer |
|---------------|---------|-----|---------|-------------|-----------|-----------|
| 174152 | 40 max. | E27 | doré | Ø70 x 96 mm | - | 12 |
| 174153 | 40 max. | E27 | argenté | Ø70 x 96 mm | - | 12 |
| 174154 | 40 max. | E27 | noir | Ø70 x 96 mm | - | 12 |

► Source lumineuse non incluse



976663
EDISON ambrée
E27 | 5W | 2000K | 300lm
Non dimmable

174155 | 174156



V. AC
220-240V
HG = 0,0mg

| Ref. | W | E27 | Light Bulb Icon | Dim. mm | PCB Inner | PCB Outer |
|---------------|---------|-----|-----------------|---------------|-----------|-----------|
| 174155 | 40 max. | E27 | blanc | Ø115 x 110 mm | - | 9 |
| 174156 | 40 max. | E27 | noir | Ø115 x 110 mm | - | 9 |

► Source lumineuse non incluse





CE | V. AC
220-240V
50/60Hz

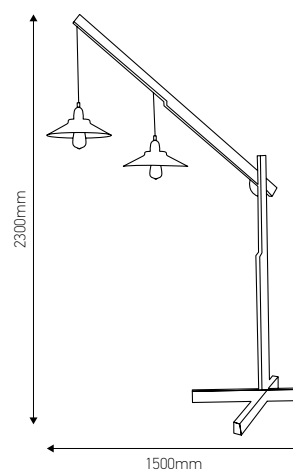

LAMPES À POSER

| Ref. | W | | Dim. mm | PCB Inner | PCB Outer |
|--------|-------------|-----|-------------|--------------|--------------|
| 300475 | 2 x 60 max. | E27 | 2300 x 1500 | - | 1 |

► Source lumineuse non incluse

DESKY LUMINAIRE SUR PIED LED



V. AC
220-240V
50/60Hz



Ra
≥80

PF
≥0.9

UGR
<21

650°



158872

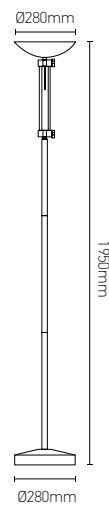

| Ref. | W | K | lm | mA | LED | ★ | Kg | Dim. Ø x H _{mm} | 📦 |
|--------|----|-----------|------|------------------|--------|--------|------|--------------------------|---|
| 158872 | 35 | 2800-3100 | 3100 | ↻ 195mA ↻ 1200mA | 100pcs | HONGLI | 10.5 | Ø280 x 1950 | 2 |

► Sources lumineuses inclus





LAMPE À POSER BÉTON E27



V. AC
220-240V
50/60Hz



200800



200802



200801

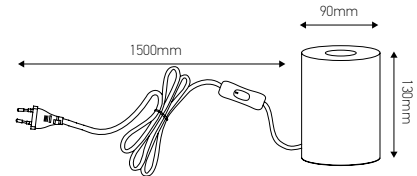
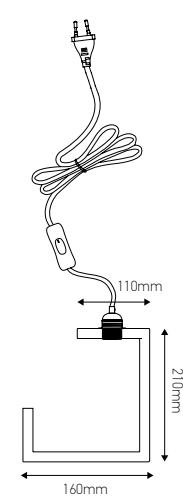
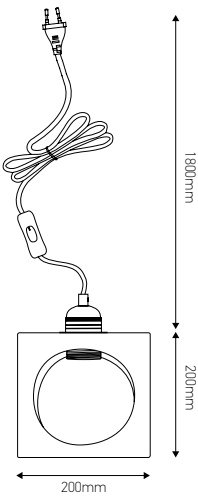

250 x 250 x 160mm



250 x 250 x 160mm

| Ref. | W | | Longueur des câbles | Kg | PCB Inner | PCB Outer |
|--------|---------|-----|---------------------|------|-----------|-----------|
| 200800 | 40 max. | E27 | 1.8m | 4.4 | 1 | 2 |
| 200802 | 40 max. | E27 | 1.8m | 1.7 | 1 | 6 |
| 200801 | 40 max. | E27 | 1.5m | 1.31 | 1 | 8 |

► Source lumineuse non incluse

LAMPE À POSER BOIS E27



V. AC
220-240V
HG = 0,0mg



18471

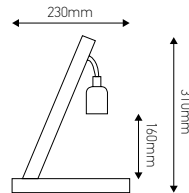

145 x 46 x 305mm

| Ref. | W | E27 | Longueur des câble | kg | Dim. mm | PCB Inner | PCB Outer |
|-------|----------|-----|--------------------|------|----------------|-----------|-----------|
| 18471 | 40W max. | E27 | 1.8m | 0.47 | 230 x 80 x 310 | 1 | 10 |

Matériau | Bois + métal

► Source lumineuse non incluse



V. AC
220-240V
50/60Hz



333003

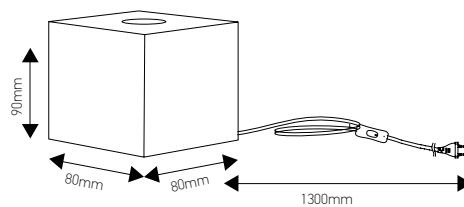

105 x 105 x 145mm

| Ref. | W | E27 | Longueur des câble | kg | Dim. mm | PCB Inner | PCB Outer |
|--------|----------|-----|--------------------|------|--------------|-----------|-----------|
| 333003 | 40W max. | E27 | 1.3m | 0.46 | 80 x 80 x 90 | 1 | 8 |

► Source lumineuse non incluse





LAMPE À POSER BOIS E27



976971

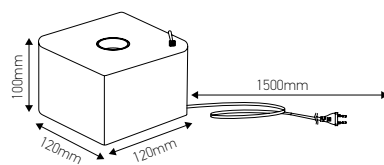

140 x 140 x 145mm

| Ref. | W | E27 | Longueur des câble | Kg | Dim. mm | PCB Inner | PCB Outer |
|--------|----------|-----|--------------------|------|-----------------|-----------|-----------|
| 976971 | 40W max. | E27 | 1.5m | 0.88 | 120 x 120 x 100 | 1 | 12 |

► Source lumineuse non incluse

LAMPE À POSER EN BAMBOU NATUREL E27



174130

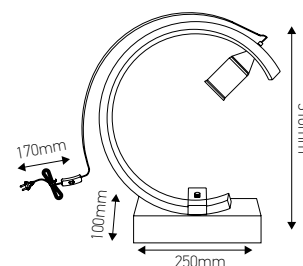
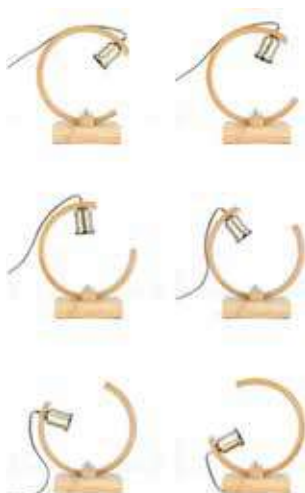

260 x 260 x 100mm

| Ref. | W | E27 | Longueur des câble | Kg | Dim. mm | PCB Inner | PCB Outer |
|--------|----------|-----|--------------------|------|-----------------|-----------|-----------|
| 174130 | 40W max. | E27 | 1.7m | 0.73 | 250 x 100 x 310 | 1 | 10 |

► Source lumineuse non incluse

LAMPE À POSER AVEC INTERRUPTEUR E27



V. AC
220-240V
50/60Hz



300456

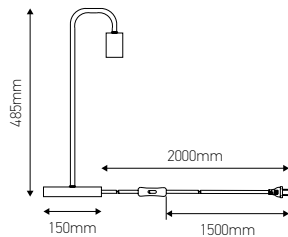

220 x 220 x 420mm

| Ref. | W | | Longueur des câble | Kg | Dim. mm | PCB Inner | PCB Outer |
|--------|----------|-----|--------------------|-----|------------|-----------|-----------|
| 300456 | 60W max. | E27 | 2m | 0.8 | Ø150 x 485 | - | 1 |

► Source lumineuse non incluse

ORI

LAMPE À POSER AVEC INTERRUPTEUR ET ABAT-JOUR MÉTAL E27



V. AC
220-240V
50/60Hz



300453



300454

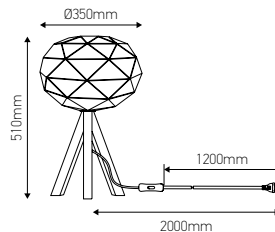

560 x 360 x 350mm

| Ref. | W | | Longueur des câble | Kg | Dim. mm | PCB Inner | PCB Outer |
|--------|----------|-----|--------------------|-----|---------|-----------|-----------|
| 300453 | 60W max. | E27 | 2m | 2.3 | Ø350 | - | 1 |
| 300454 | 60W max. | E27 | 2m | 2.3 | Ø350 | - | 1 |

► Source lumineuse non incluse



LAMPE À POSER / SUSPENDRE EN BOIS E27

V. AC
220-240V
50/60Hz

25000H

360°

Ra
≥80

OFF ON
≥15'000

100% 0 sec

-20°C
+40°C

3 ans

GROUP 0
EN62471:2008



333000

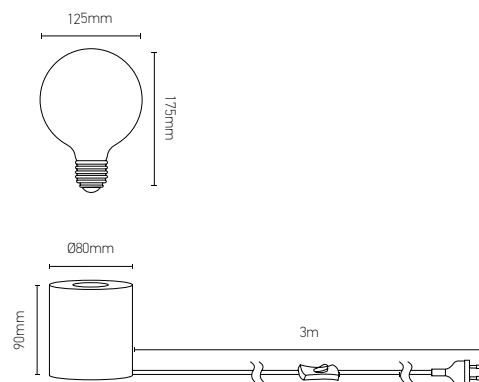
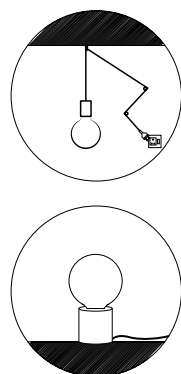

| Ref. | W | E | K | lm | mA | kg | Longueur des câble | 8 |
|--------|---|-----|------|-----|----|------|--------------------|---|
| 333000 | 5 | E27 | 2000 | 260 | 43 | 0.58 | 3m | 8 |

► Vendu avec ampoule (ref. 716602)







ABAT-JOUR DECO

| | |
|-----------------------|----|
| MÉTAL CONIQUE..... | 42 |
| MÉTAL ÉVASÉ..... | 42 |
| MÉTAL INDUSTRIEL..... | 42 |
| MÉTAL DISQUES..... | 45 |
| MÉTAL CAGE..... | 46 |





300800



300802

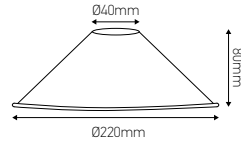

300803



300804



225 x 225 x 85mm



300903

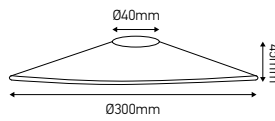

305 x 40 x 305mm



301001

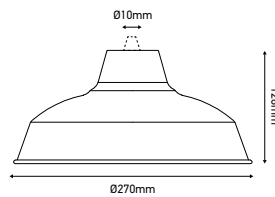

275 x 275 x 135mm



187597



187596

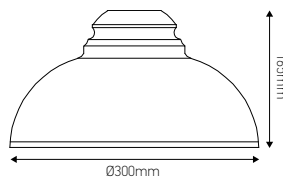

305 x 305 x 170mm

► A utiliser avec une douille à bague



187589

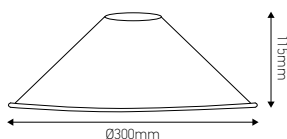

305 x 305 x 120mm

► A utiliser avec une douille à bague



187588

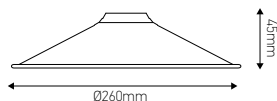

265 x 55 x 265mm

► A utiliser avec une douille à bague

ABAT-JOUR DECO

DISQUES VIS VERSA.
JOUEZ LE CONTRASTE AVEC
CES DISQUES RÉVERSIBLES.





187586
blanc et noir



187584
cuivre et noir



305 x 50 x 305mm

Petit disque | Ø220 x 2mm
Grand disque | Ø300 x 3,5mm
A utiliser avec une douille à bague

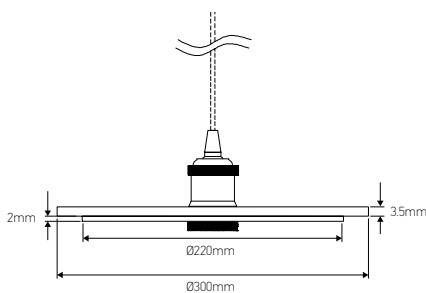

300503



300504

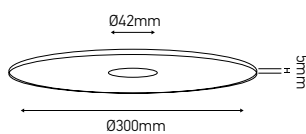

310 x 18 x 310mm

Disque | Ø300 x 5mm
A utiliser avec une douille à bague



305001



305002

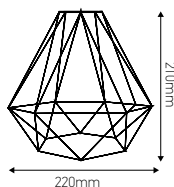

230 x 230 x 210mm

| Ref. | Couleur | Matériel | Ø x H _{mm} |
|--------|---------|----------|---------------------|
| 305001 | noir | métal | 220 x 210 |
| 305002 | cuivre | métal | 220 x 210 |







APPLIQUES

| | |
|-------------------|----|
| APPLIQUE G9..... | 50 |
| APPLIQUE E27..... | 51 |

60W
Max.

V. AC
220-240V
50/60Hz



300250



300251

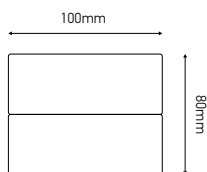

105 x 105 x 90mm

► Ampoule G9 non incluse



► Source lumineuse non incluse

60W
Max.



300200

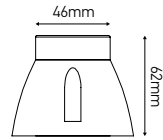

80 x 80 x 70mm



300210



300211

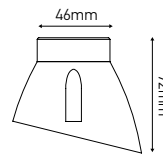

80 x 80 x 70mm



300220



300221

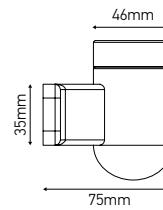

85 x 85 x 85mm



► Source lumineuse non incluse



► Source lumineuse non incluse



EN 60598-2-1 | 1989
 utilisé en conjonction avec
 EN 60598-1 | 2015
 EN 62031 | 2008+A1 | 2013+A2 | 2015
 EN 62471 | 2008



167513



167512

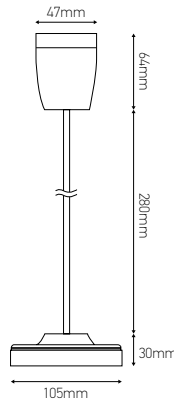

Ø110 x 180mm

Tube flexible
 Section du câble | 2 x 0.75mm²
 Type de câble | H05V-K



167511



167510

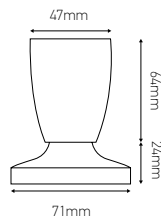

72 x 72 x 87mm

Section du câble | 2 x 0.75mm²
 Type de câble | H05V-K

APPLIQUES



► Source lumineuse non incluse



SUSPENSIONS DECO



| | |
|---|----|
| SUSPENSIONS MARBRE NOUVEAUTÉ | 57 |
| SUSPENSIONS PORCELAINE..... | 57 |
| SUSPENSIONS BÉTON..... | 58 |
| SUSPENSIONS MÉTALLIQUES..... | 58 |
| SUSPENSIONS SILICONES..... | 66 |
| SUSPENSIONS PLASTIQUE..... | 66 |
| SUSPENSIONS CHANVRE NATUREL..... | 69 |



60W
Max.



10

241607



241608

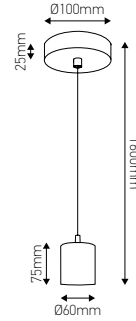

NOUVEAUTÉ

Section du câble | 2 x 0.75mm²
Type de câble | H03VV-F
Matériau
• Rosace | Marbre
• Douille | Marbre
• Câble | Textile

SUSPENSION PORCELAINE E27 L.1000 / 2000mm



60W
Max.



10

167518



167519

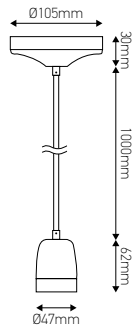

187562

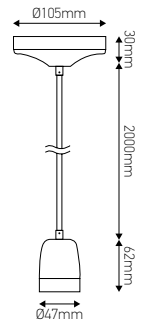

Section du câble | 2 x 0.75mm²
Type de câble | H03VV-F
Matériau
• Rosace | Porcelaine
• Douille | Porcelaine
• Câble | Textile



Ø110 x 100mm

SUSPENSION BÉTON E27 L.2000mm



60W
Max.



10

187557

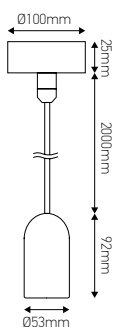

Section du câble | 2 x 0.75mm²

Type de câble | H03VV-F

Matériau

- Pavillon | Acier
- Douille | Béton
- Câble | Textile



Ø110 x 125mm

SUSPENSION MÉTALLIQUE E27 L.1000



60W
Max.



10

241606

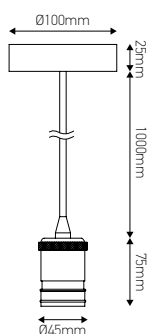

Section du câble | 2 x 0.75mm²

Type de câble | H03VV-F

Matériau

- Pavillon | Acier
- Cache-douille | Aluminium
- Douille | Plastique
- Câble | Textile



Ø110 x 100mm



SUSPENSION MÉTALLIQUE E27 L.2000mm



60W
Max.



187516



187517

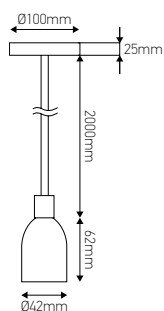

Section du câble | 2 x 0.75mm²
Type de câble | H03VV-F
Matériau
• Pavillon | Acier
• Cache-douille | Aluminium
• Douille | Plastique
• Câble | Textile



Ø110 x 100mm

SUSPENSION MÉTALLIQUE E40 L.2000mm



60W
Max.



187515



200900



200901

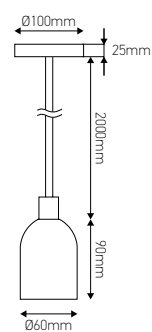

Section du câble | 2 x 0.75mm²
Type de câble | H03VV-F
Matériau
• Pavillon | Acier
• Cache-douille | Aluminium
• Douille | Céramique
• Câble | Textile



Ø110 x 150mm



SUSPENSION MÉTALLIQUE AVEC DOUILLE FILLETÉE ET BAGUE DE SERRAGE E27 L.2000mm



187585

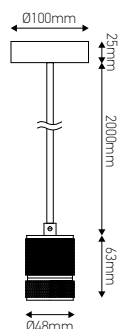

Section du câble | 2 x 0.75mm²
Type de câble | H03VV-F
Matériau
• Pavillon | Acier
• Cache-douille | Aluminium
• Douille | Plastique
• Câble | Textile

Utilisation
Peut être utilisé avec un abat-jour
ou une verrerie



Ø110 x 125mm

SUSPENSION MÉTALLIQUE AVEC BAGUE E27 L.1000



300410

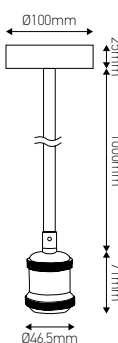

Section du câble | 2 x 0.75mm²
Type de câble | H03VV-F
Matériau
• Pavillon | Acier
• Cache-douille | Aluminium
• Douille | Plastique
• Câble | Textile

Utilisation
Peut être utilisé avec un abat-jour
ou une verrerie



Ø110 x 100mm

SUSPENSION MÉTALLIQUE AVEC DOUILLE FILLETÉE ET BAGUE E27 L.1000mm



241604



241605

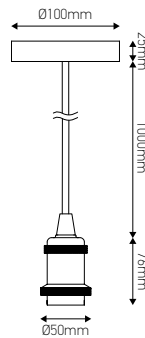

Section du câble | 2 x 0.75mm²
 Type de câble | H03VV-F
 Matériau
 • Pavillon | Acier
 • Cache-douille | Aluminium
 • Douille | Plastique
 • Câble | Textile

Utilisation
 Peut être utilisé avec un abat-jour
 ou une verrerie



Ø110 x 100mm

SUSPENSION MÉTALLIQUE AVEC DOUILLE CYLINDRE FILLETÉE ET BAGUE E27 L.2000mm



187563

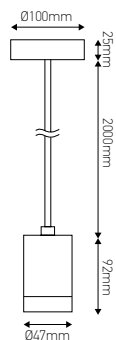

Section du câble | 2 x 0.75mm²
 Type de câble | H03VV-F
 Matériau
 • Pavillon | Acier
 • Cache-douille | Aluminium
 • Douille | Plastique
 • Câble | Textile

Utilisation
 Peut être utilisé avec un abat-jour
 ou une verrerie



Ø110 x 125mm



40W
Max.



12



174162



174160



174161

Couleur | noir / doré / cuivré
Matériau | Laiton
Longueur du câble | 1,35m

*Source lumineuse non incluse

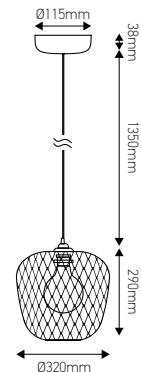



► Source lumineuse non incluse

SUSPENSION SILICONE E27 L.800mm



241879



241880

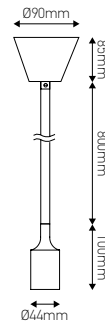

Ø110 x 125mm

Section du câble | 2 x 0.75mm²
 Type de câble | H05SS-F
 Matériau
 • Pavillon | Polypropylène
 • Cache-douille | Silicone
 • Douille | Plastique
 • Câble | Silicon

SUSPENSION PLASTIQUE AVEC BAGUE CÂBLE NYLON E27 (L. 0.6m)

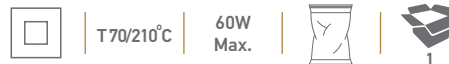

EN 60598-1 2015



241851



241853



241857

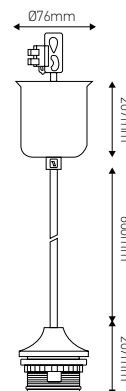

| Réf. | ⚡ | 💡 | Matériau | Type de câble | Section du câble |
|--------|-----|-------|---------------|---------------|-------------------------|
| 241851 | E27 | noir | polypropylène | H03V2V2F-F | 2 x 0.75mm ² |
| 241853 | E27 | blanc | polypropylène | H03V2V2F-F | 2 x 0.75mm ² |
| 241857 | E27 | or | polypropylène | H03V2V2F-F | 2 x 0.75mm ² |

Chape de suspension avec pince et barrette de connexion 4mm² - 2 plots
 Pavillon avec anneau et vis de blocage
 Serre-câble en nylon
 Poids max. de l'abat-jour 1kg - trou Ø40mm

241879
Suspension
Silicone

► Source lumineuse non incluse



200700
Corde de chanvre

976647
ZAVONA E27

LEAF CORDE DE CHANVRE + BOIS - E27

V. AC
220-240V
50/60Hz



40W
Max.

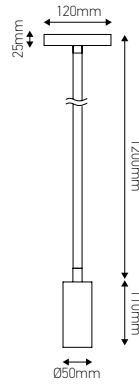

Section du câble | 2 x 0.75mm²
Type de câble | H03VV-F

200700



265 x 265 x 340mm

CÂBLE CHANVRE TORSADÉ 2 x 0.75mm²



60W
Max.



187599

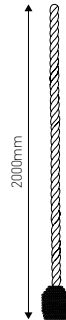

Avec douille E27
Ø25mm
Type de câble | H03VV-F



150 x 150 x 150mm



187599
Câble Chanvre
Torsadé

716602
Globe twisted



ROSACES ET PAVILLONS DECO

| | |
|--------------------------------------|----|
| PAVILLON BOIS NOUVEAUTÉ | 74 |
| PAVILLON PORCELAINE | 74 |
| PAVILLON ACIER SORTIE SIMPLE | 76 |
| PAVILLON ACIER 3 OU 6 SORTIES | 78 |
| PAVILLON ACIER 5 SORTIES | 80 |
| PAVILLON ACIER RECTANGLE | 82 |
| CROCHET MÉTAL POUR FIXATION | 83 |

PAVILLON BOIS SORTIE SIMPLE D100mm



300706

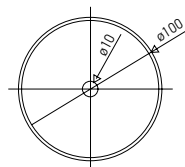
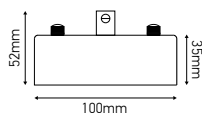

NOUVEAUTÉ

Sortie simple
Matériel : bois

PORCELAINE ROSACE PORCELAINE AVEC ARRÊT DE CÂBLE Ø105 / Ø68mm



187518



187519



187520



187521

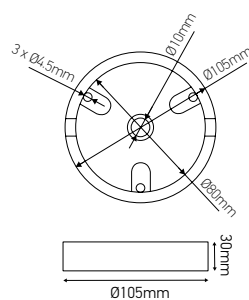

105 x 35 x 105mm



300300



300301

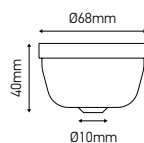

70 x 56mm

Vendu avec kit de montage et barette de fixation,
serre câble assorti, domino, écrous.
Ø maximum de câble | 7mm





187572



187573

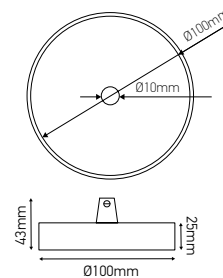

187522



187523



187524



105 x 35 x 105mm



300352



300351



300353



300354



300356



300357



300702



300703



300704



300705

Vendu avec kit de montage et barette de fixation,
serre câble assorti, domino, écrous.
Ø max du câble | 7mm





187525



187526



187527



187528

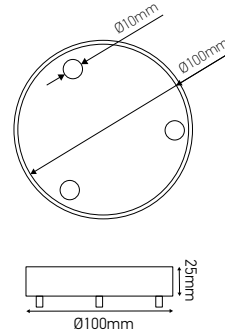

105 x 35 x 105mm

Vendu avec kit de montage et barette de fixation, serre câble assorti, domino, écrous. Ø maximum de câble | 7mm

PAVILLON ACIER 6 SORTIES AVEC ARRÊT DE CÂBLE Ø100mm



187529

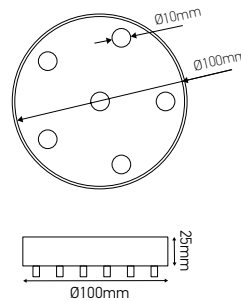

105 x 35 x 105mm

Vendu avec kit de montage et barette de fixation, serre câble assorti, domino, écrous. Ø maximum de câble | 7mm





187574



187575



187576



187577



187578

Vendu avec kit de montage et barette de fixation, serre câble assorti, domino, écrous. Ø maximum de câble | 7mm

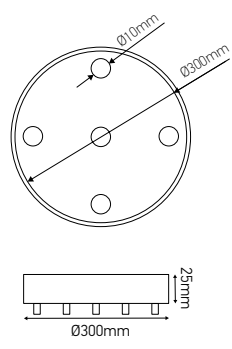

310 x 30 x 310mm





187613
Pavillon rectangle

189640
Câble textile rond

187564
Douille Alu noire

LICA PAVILLON ACIER RECTANGLE 300mm



187610
2 sorties

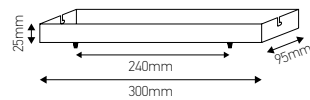

LICA PAVILLON ACIER RECTANGLE 470mm



187612
3 sorties



187613
3 sorties

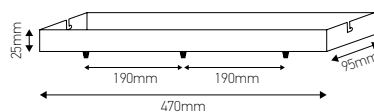

LICA PAVILLON ACIER RECTANGLE 900mm



187614
4 sorties



187615
4 sorties

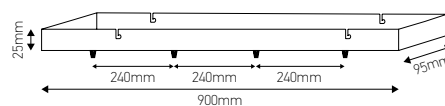

187616
7 sorties



187617
7 sorties

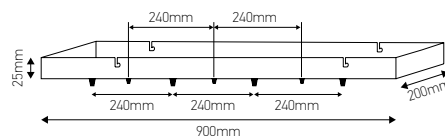

STEELY CROCHET MÉTAL AVEC VIS DE FIXATION AVEC ARRÊT DE CÂBLE



310001
(3pcs)
50 x 50 x 50mm



310002
(5pcs)
50 x 50 x 50mm



310004
(3pcs)
50 x 50 x 50mm



310005
(5pcs)
50 x 50 x 50mm

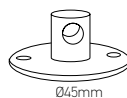
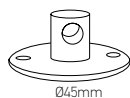

PAVILLONS DÉCO



PAVILLONS TECHNIQUES

| | |
|---------------------------------|----|
| PAVILLON POLYPROPILÈNE..... | 86 |
| PAVILLONS LAITON ET ACIER | 87 |

PAVILLON POLYPROPILÈNE



60W
Max.



EN 60598-1 2008
A1 2009



241975



241974

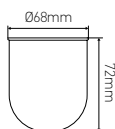

241983

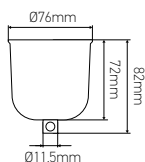

241962

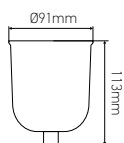

| Réf. | Matériau | Description | Ømm |
|--------|---------------|---------------------------------------|-----------|
| 241975 | polypropylene | pavillon tronconique | Ø68 x 72 |
| 241974 | polypropylene | pavillon tronconique | Ø68 x 72 |
| 241983 | polypropylene | pavillon cylindrique avec vis d'arrêt | Ø76 x 82 |
| 241962 | polypropylene | a visser sur le monte et baisse | Ø91 x 113 |

PAVILLON POLYPROPILÈNE CONIQUE AVEC VIS D'ARRÊT



241993

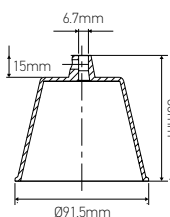

| Réf. | Matériau | Ømm |
|--------|---------------|------------|
| 241993 | polypropylene | Ø91.5 x 86 |



282852

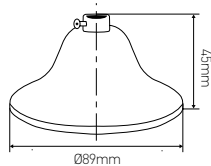

282963

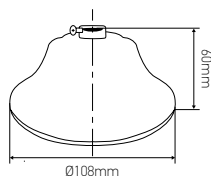

| Réf. | Matériau | Pour tube | Dim. Ø x H _{mm} |
|--------|---------------------|-----------|--------------------------|
| 282852 | laiton brossé verni | Ø10mm | Ø89 x 45mm |
| 282963 | acier | Ø10mm | Ø108 x 60mm |

PAVILLONS TECHNIQUES



283884



283895

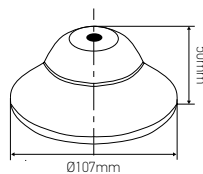

| Réf. | Matériau | Trou Ø _{mm} | Dim. Ø x H _{mm} |
|--------|-------------------|----------------------|--------------------------|
| 283884 | laiton chromé | 11 | Ø107 x 50 |
| 283895 | laiton poli verni | 11 | Ø107 x 50 |



DOUILLES DECO

| | |
|----------------------------------|----|
| ACIER E27 NOUVEAUTÉ | 90 |
| BOIS E27 NOUVEAUTÉ | 90 |
| PORCELAINE E27 | 92 |
| BÉTON E27 | 95 |
| ALUMINIUM E27 | 95 |
| CUIVRE E27 | 97 |
| MÉTALLIQUE E27 | 97 |
| BAKÉLITE E27 | 99 |

DOUILLE ACIER E27 AVEC INTERRUPTEUR + BAGUE

60W
Max.



300628



300629

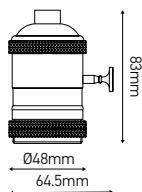

NOUVEAUTÉ

Matériau

- Intérieur | plastique
- Extérieur | aluminium

DOUILLE BOIS E27



300630

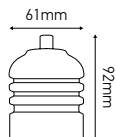

NOUVEAUTÉ

Matériau

- Intérieur | plastique
- Extérieur | bois



PORCELAINE DOUILLE CÉRAMIQUE E27



158063



187540



187541



187554

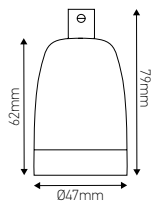

48 x 48 x 80mm



187542

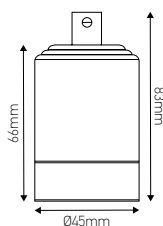

48 x 48 x 80mm

DOUILLE CÉRAMIQUE E14



300101



300102

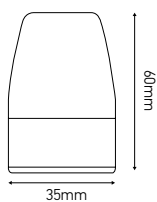

50 x 50 x 75mm







300611



300612



300613



300614



300616

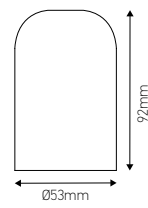

48 x 48 x 95mm



300621



300622



300623



300624



300626



300627

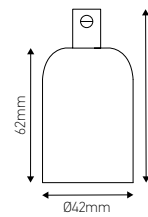

48 x 48 x 80mm



187547



187548



187549

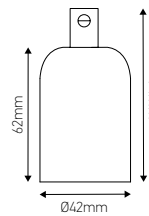

48 x 48 x 80mm



187552

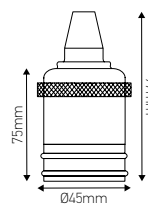

48 x 48 x 80mm



187564

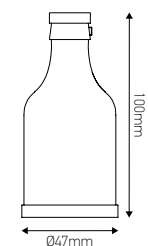

48 x 48 x 105mm



187568



187569



187570

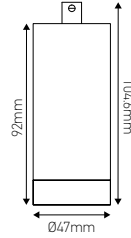

48 x 48 x 105mm



300600



300601



300602



300604

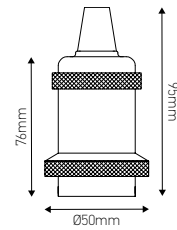

48 x 48 x 80mm



187571

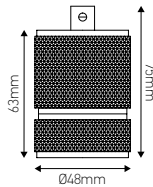

48 x 48 x 80mm

DOUILLE ACIER FILETÉE E27

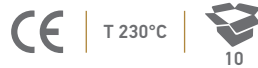

187546
Ø40 x 72mm

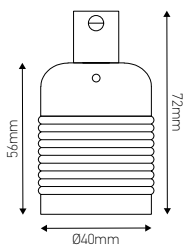

48 x 48 x 80mm

DOUILLE ALUMINIUM FILETÉE E27 AVEC BAGUE



187543



187544

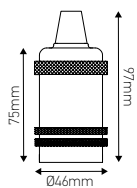

48 x 48 x 80mm



187550



187551

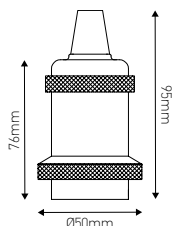

48 x 48 x 80mm

DOUILLE FILETÉE CUIVRE E27 AVEC BAGUE



187553

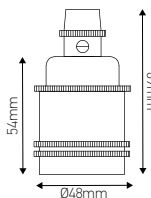

48 x 48 x 80mm

DOUILLE MÉTALLIQUE FILETÉE E27 AVEC BAGUE

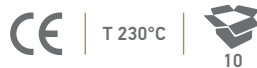

EN60238 2004
A1 2008
A2 2016



220883
Ø60 x 59mm



220884
Ø60 x 59mm





DOUILLE MÉTALLIQUE FILETÉE E14 AVEC BAGUE



T 230°C



EN60238 2004
A1 2008
A2 2011



210883
Ø42.5 x 66mm



210884
Ø42.5 x 66mm

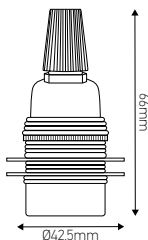

DOUILLE BAKÉLITE E27



T 165°C



EN60238 2004
A1 2008
A2 2015



219331
avec interrupteur
Ø39 x 97mm

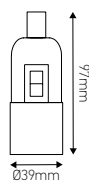

DOUILLES DÉCO



DOUILLES TECHNIQUES

| | |
|---------------------------------|-----|
| DOUILLES E27 | 102 |
| DOUILLES E14..... | 106 |
| DOUILLES E12..... | 109 |
| DOUILLES E26..... | 110 |
| DOUILLES MÉTAL E27/E14..... | 112 |
| BAGUES DE SERRAGE..... | 113 |
| DOUILLES S14D / S14S | 114 |
| RÉDUCTEURS DE BAGUES..... | 114 |
| DOUILLES B22 / B15..... | 116 |
| DOUILLES SPÉCIFIQUES..... | 118 |
| ADAPTATEURS POUR DOUILLES | 126 |

DOUILLE MONTÉE E27



EN60238

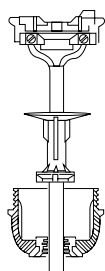

Thermoplastique



Pastille bornes à vis
Utiliser un isostop réf. 231627



Culot raccord métal 10 x 1 avec dispositif de retenue et vis d'arrêt

CHEMISE LISSE Ø39mm



216351



216353



216357

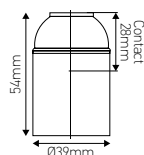

CHEMISE FILETÉE Ø40



216551



216553



216557

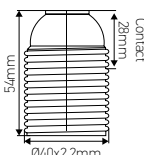

CHEMISE SEMI-FILETÉE Ø46mm



216651



216653



216657

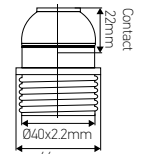

SEMI-FILETÉE AVEC LA TERRE ET SORTIE



216451



216457

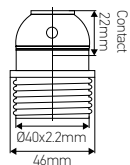

Avec sortie latérale et portée

CHEMISE LISSE AVEC LA TERRE Ø39mm



216251

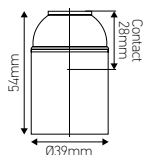

CHEMISE SEMI-FILETÉE AVEC LA TERRE Ø40mm



216751

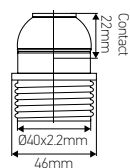

DOUILLE DÉMONTÉE E27 CHEMISE SEMI-FILETÉE AVEC PASTILLE AUTOMATIQUE Ø40mm

EN60238

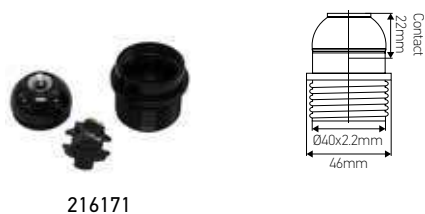

216171

CHEMISE FILETÉE AVEC PASTILLE AUTOMATIQUE Ø40mm

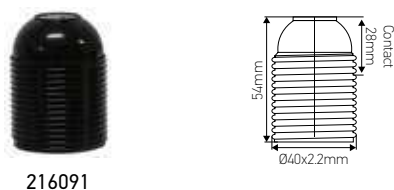

216091

DOUILLE MONTÉE 27 AVEC INTERRUPTEUR ET PORTÉE



219351

219323

Douille avec interrupteur, raccord métal 10 x 1, vis d'arrêt
Chemise fileté Ø40mm avec portée interrupteur incorporé



DOUILLE MONTÉE E14



EN 60238
EN60238 2004 | A1 2008 | A2 2019

Isolant thermodurcissable
Thermoplastique
Utiliser un isostop réf. 231614
Livrée montée avec pastille à l'envers
Pastille bornes à vis

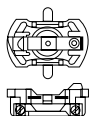

Les douilles, culot hauteur 16mm permettent un équipement classe II si elles sont montées sur un support plastique. Equipement classe I montage sur raccord métallique relié à la terre. Culot raccord métal 10 x 1 avec dispositif de retenue, vis d'arrêt et borne de terre

CHEMISE LISSE À CULOT COURT Ø27mm H15



213051



213053



213057

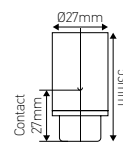

CHEMISE FILETÉE À CULOT COURT Ø28mm



213151



213153



213157

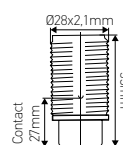

CHEMISE SEMI-FILETÉE AVEC PORTÉE À CULOT COURT Ø28mm



213291



213293



213297

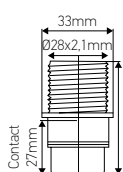

CHEMISE LISSE Ø27mm CULOT H21



213501

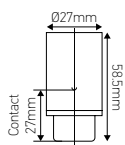

DOUILLE DÉMONTÉE E14

EN60238



Isolant thermodurcissable
Utiliser un isostop réf. 231627



Culot raccord 10 x 1 et vis d'arrêt
Culot hauteur 16mm, passage de câble Ø5,5mm

Douille, culot hauteur 16mm. Utilisation avec isostop réf. 231734 spécifique pour culot avec passage de câble latéral pour lampe à poser classe II. Montage lustrerie classe I, sortie du câble sur bras de lustres.

Attention | l'utilisation du culot 16mm avec isostop pour passage de câble latéral ne permet pas la conformité du montage au niveau des distances dans l'air.

CHEMISE LISSE E14 Ø27mm



213361



213363

DOUILLE TRANSPARENTE AUTOMATIQUE E14

EN60238



214514
Chemise lisse
Ø26,5 x 58mm



214534
Chemise fileté
Ø26,5 x 58mm

Matériau | Thermoplastique

Bornes à ressort pour Câble rigides ou flexibles à partir de 0,5 ÷ 1,5mm²

Raccordement | trous traversants pour vis auto-enfilage 3mm ou avec dômes à encliquetage

Avec raccord fileté M10 x 1, avec dispositif de retenue et vis d'arrêt

DOUILLE DÉMONTÉE E14



EN60238

Isolant thermoplastique

Utiliser un isostop réf. 231627

Dénudage du câble | 7mm - section conducteur 0,5 à 1,5mm² - câble souple ou rigide

Bornes automatiques débrochables, culot clipsable 10 x 1

Douille, culot haut. 21,5mm pour l'équipement des luminaires classe II. Le volume intérieur du culot permet l'insertion d'un isostop réf. 231614

Culot haut. 21,5mm taraudé 10 x 1 vis d'arrêt

CHEMISE LISSE E14 Ø26mm



214513

CHEMISE SEMI-FILETÉE AVEC PORTÉE DOUILLE AUTOMATIQUE E14 Ø28mm



214563

DOUILLE DÉMONTÉE E12 CHEMISE SEMI-FILETÉE



215273

Thermoplastique

Non-assemblé | 3 éléments séparés

Note | pour des raisons de standardisation, ces éléments ne sont pas commercialisés séparément

DOUILLE THERMOPLASTIQUE DÉMONTÉE E26 USA

T 150°C



Thermoplastique

Non-assemblé | 3 éléments séparés

Note | pour des raisons de standardisation, ces éléments ne sont pas commercialisés séparément

CHEMISE SEMI-FILETÉE E26 Ø46mm



221681
Ø46 x 51.5mm

DOUILLE DÉMONTÉE E12 CHEMISE FILETÉE



215163
Douilles isolant thermodurcissable



216173

DOUILLE E27 LISSE ACIER LAITONNE



220960
acier laitonné

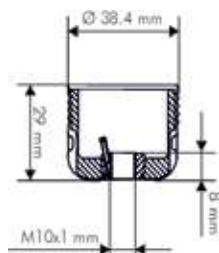

Douille, raccord métal 10 x 1, vis d'arrêt
utilisation avec borne de mise à la terre sur le luminaire



DOUILLE MONTÉE E27 / E14

T 230°C



EN60238

Matériau | Acier
Avec dispositif de blocage et borne de terre
Raccord métal 10 x 1, vis d'arrêt
Bornes à vis
Câble à utiliser | 0,5 to 2,5mm²
Livrée montée avec pastille à l'envers

CHEMISE FILETÉE AVEC LA TERRE E27 Ø38mm

4A
250V



220879
Ø38 x 64mm



220889
Ø38 x 64mm



220888
Ø38 x 64mm



220881
Ø38 x 64mm

CHEMISE FILETÉE AVEC LA TERRE E14

2A
250V



210879
Ø25 x 62mm



210889
Ø25 x 62mm



210888
Ø25 x 62mm

Terminal | vis pour câble rigide ou flexible 0,5 ÷ 2,5mm²

DOUILLE FILETÉE AVEC ISOLATEUR E27 Ø38mm



220969

Blanc zingué
Raccord métal 10 x 1, vis d'arrêt
Bornes à vis
Câble à utiliser | 0,5 to 2,5mm²
Livrée montée avec pastille à l'envers
(Ø x H) | Ø38 x 64mm

BAGUE POUR DOUILLE E27

T 230°C |  10



| Réf. |  | Matériau | Dim. Ø x H _{mm} |
|---------------|---|-----------------|--------------------------|
| 220979 | E27 | acier | Ø60 x 15.5mm |
| 220989 | E27 | acier | Ø60 x 15.5mm |
| 220988 | E27 | acier | Ø60 x 15.5mm |
| 220981 | E27 | acier | Ø60 x 15.5mm |
| 218421 | E27 | thermoplastique | Ø57 x 12mm |
| 218423 | E27 | thermoplastique | Ø57 x 12mm |

| Réf. |  | Matériau | Dim. Ø x H _{mm} |
|---------------|---|-----------------|--------------------------|
| 218427 | E27 | thermoplastique | Ø57 x 12mm |
| 218433 | E27 | thermoplastique | Ø57 x 12mm |
| 218401 | E27 | thermoplastique | Ø47 x 9mm |
| 218403 | E27 | thermoplastique | Ø47 x 9mm |
| 218407 | E27 | thermoplastique | Ø47 x 9mm |

BAGUE POUR DOUILLE E14

T 230°C |  10



| Réf. |  | Matériau | Dim. Ø x H _{mm} |
|---------------|---|-----------------|--------------------------|
| 210979 | E14 | acier | Ø42.5 x 11mm |
| 210989 | E14 | acier | Ø42.5 x 11mm |
| 210988 | E14 | acier | Ø42.5 x 11mm |
| 214451 | E14 | thermoplastique | Ø43 x 9.5mm |
| 214453 | E14 | thermoplastique | Ø43 x 9.5mm |

| Réf. |  | Matériau | Dim. Ø x H _{mm} |
|---------------|---|-----------------|--------------------------|
| 214457 | E14 | thermoplastique | Ø43 x 9.5mm |
| 214444 | E14 | thermoplastique | Ø43 x 9.5mm |
| 214421 | E14 | thermoplastique | Ø35 x 7mm |
| 214423 | E14 | thermoplastique | Ø35 x 7mm |
| 214427 | E14 | thermoplastique | Ø35 x 7mm |

DOUILLE POUR LAMPE S14D / S14S

250V
1A

T 200°C



IEC 60838-2-1



210596



210598

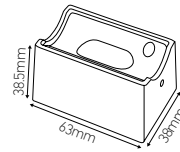

210597



210599

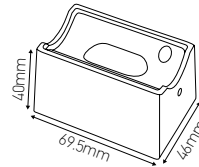

| Réf. | Matériau |  |
|---------------|---------------------|---|
| 210596 | white plastic | S14d x 1 |
| 210597 | chrome-plated metal | S14d x 1 |
| 210598 | white plastic | S14s x 2 |
| 210599 | chrome-plated metal | S14s x 2 |

S14s vendus par paire

RÉDUCTEURS DE BAGUES E27 / E14 - B22



233353



233367

| Ref. | Matériau | Ø mm |
|---------------|----------|------|
| 233353 | nylon | Ø44 |
| 233367 | nylon | Ø44 |



DOUILLE B22 PAS DES BECS AVEC BAGUE



210206

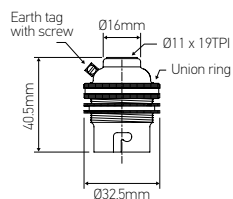

210215
avec trou latéral

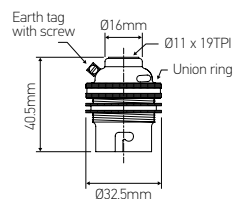

PAS INTERNATIONAL



210221

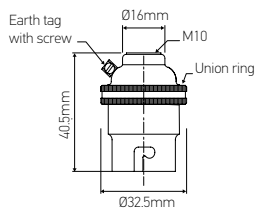

210226
Avec bague

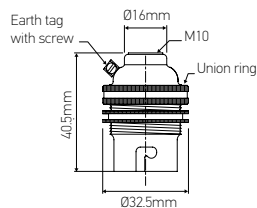

210229
Avec trou latéral et double bague

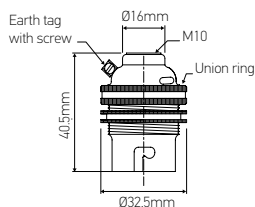

142693
pas international (et non bec)

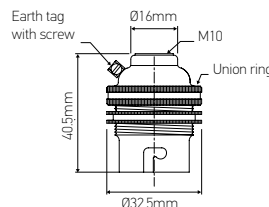

PAS INTERNATIONAL AVEC INTERRUPTEUR POUSSOIR ET BAGUE (BC)



EN 61184



210258

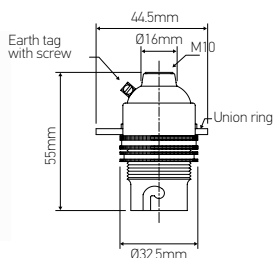

DOUILLE À BAÏONNETTE EN LAITON B22 AVEC PATÈRE (SBC)



NF - EN 61184



210247

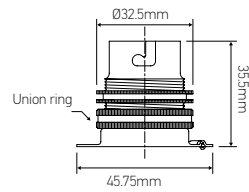

Patère Ø45mm avec borne de terre
Laiton

DOUILLE À BAÏONNETTE EN LAITON B15 (SBC)



EN 61184



210298

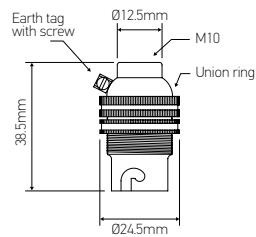

Douille à baïonnette en laiton pas international avec double bague
Raccord femelle 10 x 1. Vis d'arrêt et borne de terre

DOUILLES TECHNIQUES

PINCE DE SERRAGE POUR DOUBLE BAGUE



210385

Matériau | Aluminium

DOUILLE SPECIFIQUES GU10

2A
250V

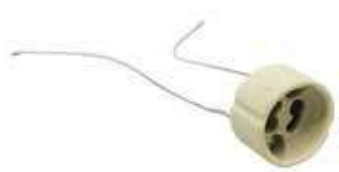

262171

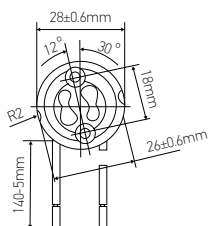

262185

Porcelaine
Pour lampes halogène basse tension
Sortie de câble verticale
Câble PTFE 0,75
L. 150mm - extrémités sertis Ø28mm

PET 180°C
Capuchon fileté 10 x 1
Pour montage classe II Ø30mm

DOUILLE GU10 AVEC SUPPORT

CE



262180

Support câble en silicone | 15cm
Non compatible avec les enjoliveurs en métal embouti

VIS AUTO-TARAUDEUSE POUR GU10

100/1000



262100

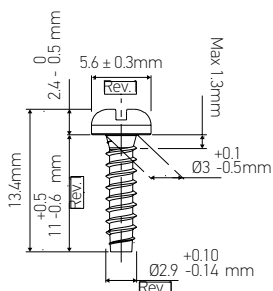

DOUILLE ET LED G9

2A
250V | T 280°C



269147



269146

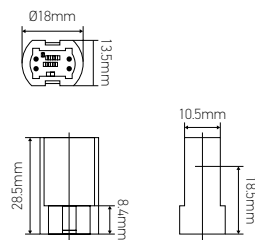

Stéatite
Ø18mm
Compatible avec la réhausse 269324

CULOT ACIER 10 x 100 CLIPSABLE POUR DOUILLE G9



269148



269150

REHAUSSE CLIPSABLE POUR G9

EN 60838-1



269324

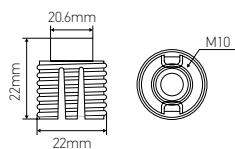

Rehausse PPS filetage M10 x 1
Pour lampes halogène basse tension
Hauteur | 21.1mm

BAGUE POUR DOUILLE G9 LCP BEIGE

T 250°C

0.5A
250V



EN 60838 -1



269168

VIS POUR DOUILLE POUR DOUILLE TBT



157163
Ø3 x 11mm

Finition | Zingué

MANCHON PPS POUR DOUILLE TBT FEMELLE 10 x 1

T 220°C



262049

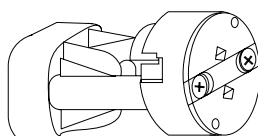

Ø17 x 12.1mm

DOUILLE SUR PATÈRE 12V



210571
Patère E14 - D 38mm

Matière isolante noir DE
Utilisation exclusive 12 Volts

DOUILLE POUR SOURCES HALOGÈNE TBT

10A
12V

T 300°C



262048

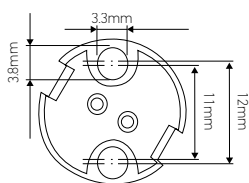
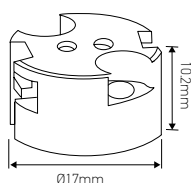

Contacts laiton nickelé 17 x 11mm
Entraxe de fixation 11mm, trous Ø3,3mm
Câble téflon | 1 x 0.75mm² - T 200°C - L.1m
Protection haute température

DOUILLE G5 POUR SOURCES HALOGÈNE TBT



10A
12V

T 120°C



262046

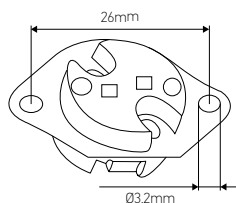

Contacts laiton nickelé 17 x 11mm
Câbles silicone 1 x 0.75mm² - T 180°C - 1.50m
Ø26mm
Protection haute température

DOUILLE G4 POUR SOURCES HALOGÈNE TBT

6A
12V

T 180°C



262015

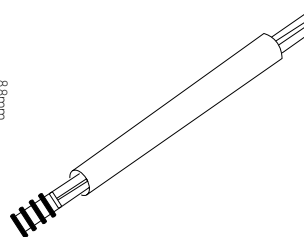
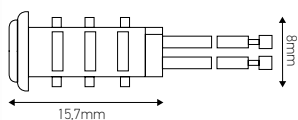

Contacts bronze nickelé
Câble silicone | 1 x 0.75mm²
Longueur 150mm pour tube
Diamètre int. 7,8 ± 0,10mm

DOUILLE EN PORCELAINE E27

4A
250V | T 180°C



153373

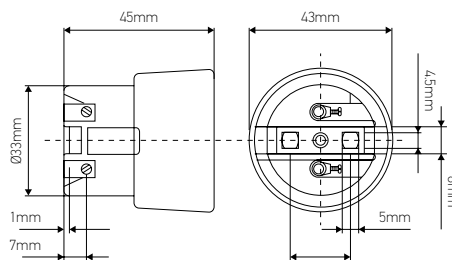

Bornes à vis pour câble rigide ou flexible 0.5 ÷ 2.5mm²
Coque vissée | Acier zingué

DOUILLE EN PORCELAINE E27 CONIQUE

4A
250V | T 210°C



221123

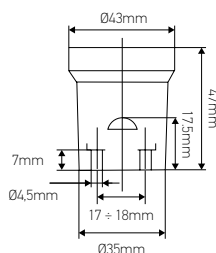

Contacts laiton nickelé
Fixation arrière par vis

DOUILLE EN PORCELAINE E27 / E40 ÉTRIER DE FIXATION AVEC BORNE DE MISE À LA TERRE

4A
250V | T 210°C



16A
500V | T 210°C



221246
E27

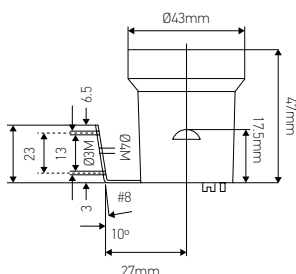

221860
E40

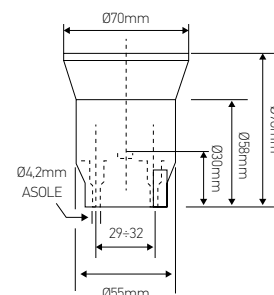

Contacts laiton nickelé
étrier de fixation avec borne de mise à la terre

DOUILLE EN PORCELAINE E27 AVEC ÉTRIER VISSÉ

4A | T210°C | 2000



221343

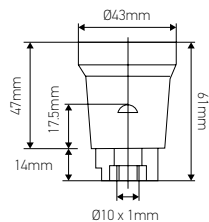

Raccord métal 10x1, vis d'arrêt et borne de mise à la terre
Contacts laiton nickelé

DOUILLE EN PORCELAINE E14 AVEC ÉTRIER VISSÉ

2A | T 210°C | 1000



221014

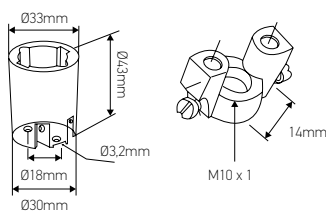

Raccord métal 10 x 1, vis d'arrêt et borne de mise à la terre
Contacts laiton nickelé

DOUILLE R7S CÉRAMIQUE

8A | T 250°C | 250



260050

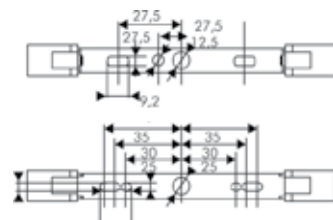
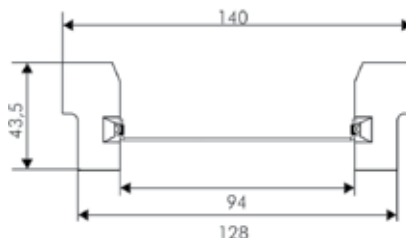

Douille avec étrier acier traité
140 x 14 x 43mm, entraxe de fixation 60mm

DOUILLE AVEC ÉTRIER R7S

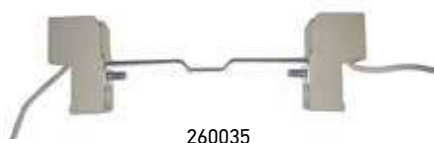

260035

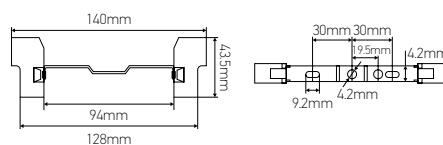

Étrier acier traité
140 x 14 x 43mm, entraxe de fixation 60mm
Câble silicone, Embout laiton
Double sertissage

DOUILLE AVEC ÉTRIER R7S



260049

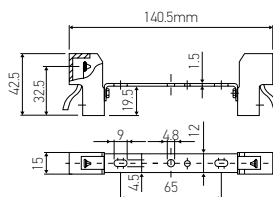

Acier
140 x 15 x 42.5mm

DOUILLE AVEC ÉTRIER R7S



260056

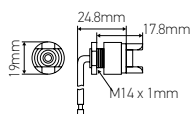

Laiton nickelé-céramique
Acier
Câble silicone L. 250mm T 180°C

DOUILLE AVEC ÉTRIER R7S



260067

Douille avec étrier
Étrier en acier traité
117.6 x 20 x 24mm, entraxe de fixation 70mm
Trou central | Ø11mm

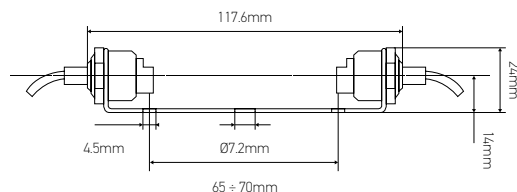

DOUILLE AVEC ÉTRIER RX7S



260078

Douille RX7S avec étrier
Étrier en acier traité
150 x 24 x 26mm, entraxe de fixation 70mm
Trou central | Ø11mm

DOUILLE POUR LAMPE «LINOLITE» S19



EN 60598



210853
S19

Lexan 740
Pour équiper les luminaires classe II
(Ø x H) | Ø30 x 43mm

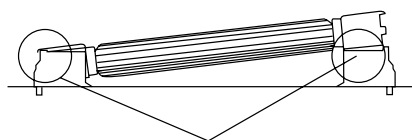

DOUILLE ET CONNECTEUR POUR LAMPE E27 DCL



253013

2A 250V
Thermoplastique
Douille thermoplastique blanc avec fiche détachable 2 pôles + terre pour le raccordement ultérieur d'un luminaire classe I ou II pour lampe B22 - 75W maxi



253003

6A 250V
Thermoplastique
Borne à vis
Câble à utiliser | 0.5 to 1mm²

EN 61184
UTE C 61390
NFC 61601

ADAPTATEUR POUR DOUILLES 60W Max.



EN 60238:2004
A1:2008



158265

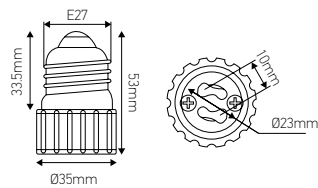

158267

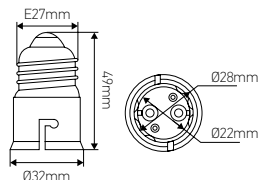

158269

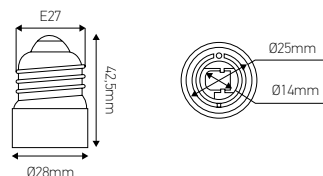

158530

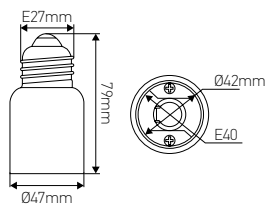

158531

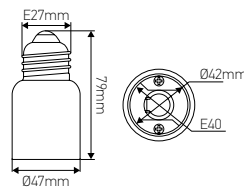

158459

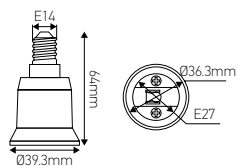

158465

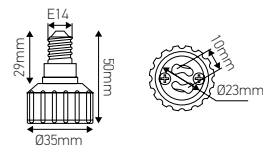

158463

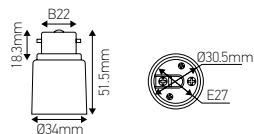

158461

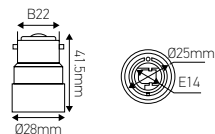

| Réf. | Matériau | Couleur | ↳ |
|--------|-----------|---------|-------------|
| 158265 | plastique | blanc | E27 => GU10 |
| 158267 | plastique | blanc | E27 => B22 |
| 158269 | plastique | blanc | E27 => E14 |
| 158530 | plastique | blanc | E27=> E40 |
| 158531 | plastique | noir | E27=> E40 |
| 158459 | plastique | blanc | E14 => E27 |
| 158465 | céramique | blanc | E14=> GU10 |
| 158463 | plastique | blanc | B22 => E27 |
| 158461 | plastique | blanc | B22 => E14 |

Directive basse tension | 2006/95/CE, annexe IV
Autres versions disponibles sur demande

ADAPTATEUR POUR DOUILLES 60W Max.



158532

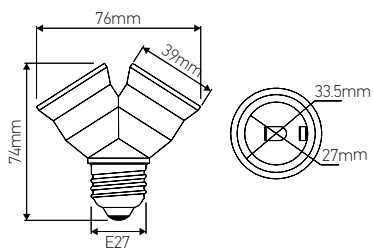

| Réf. | Matériau | | |
|--------|-----------|----------------|----|
| 158532 | plastique | E27 => 2 x E27 | 12 |

Directive basse tension | 2006/95/CE, annexe IV
Autres versions disponibles sur demande





CÂBLES DECO



| | |
|--|-----|
| CÂBLE 2m 2 x 0.75mm ² | 130 |
| BOBINE CÂBLE TISSUS | 134 |
| BOBINE CÂBLE PVC..... | 137 |
| GAINE THERMORETRACTABLE..... | 140 |



302201



302202



302203



302204



105 x 35 x 105 mm

Type de câble | H03VV-F
Double isolation
Ø6mm

CÂBLE ROND COTON 2 x 0.75mm²



189631



187531



189624



302001



105 x 35 x 105 mm

Type de câble | H03VV-F
Double isolation
Ø6mm

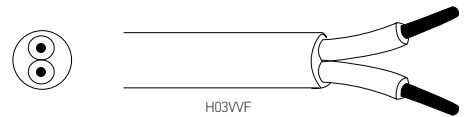

CÂBLE TEXTILE ROND 2 x 0.75mm²



187534



187535



189601



187538



187537

Type de câble | H03VV-F
Double isolation
Ø6mm



CÂBLE TEXTILE ROND 2 x 0.75mm²



187539



302107



187582



302104



302105



187581



187580



302106



187536



189626



189627

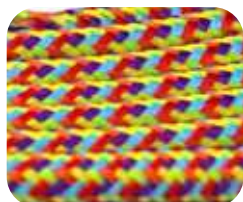

189609



189608



189607



189604



189638



189629



189643



189632



189637



189605



189639



189634



189623



189640



189633

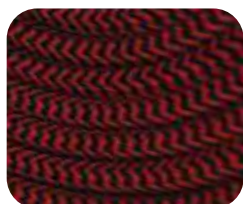

189625

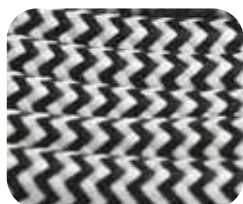

187533



105 x 35 x 105 mm

Type de câble | H03VV-F
Double isolation
Ø6mm

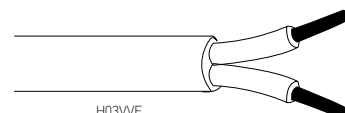

H03VVF



CÂBLE CHANVRE 2 x 0.75mm²



187598



189636

Type de câble | H05V-K
Ø8mm



105 x 35 x 105mm

CÂBLE TORSADÉ 2 x 0.75mm²



189650



189651



189614



189617



189610



187532

Type de câble | H05V-K
Double isolation
Ø6.5mm



105 x 35 x 105mm



237881



237886



237893



237894



237895

Type de câble | H03VV-F
Double isolation
Ø5.6mm

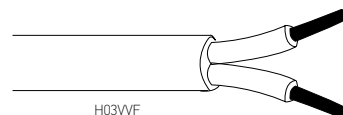
CÂBLE TEXTILE PLAT 2 x 0.75mm²

237712

Type de câble | H05VVH2-F
Double isolation
5.8 x 4mm

CÂBLE TEXTILE MÉPLAT 2 x 0.5mm²

237571



237577

Type de câble | SVOTM
Fil conducteur tressé, manchon PVC
Isolation simple



CÂBLE TEXTILE TORSADÉ 2 x 0.5mm²

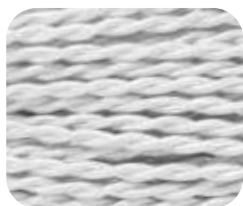

237043

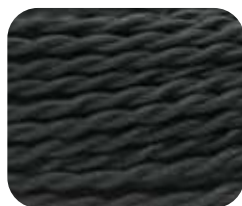

237051

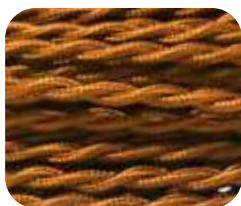

237062

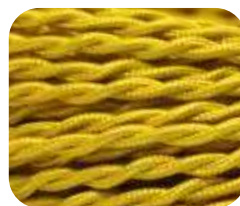

237077



237079



237094

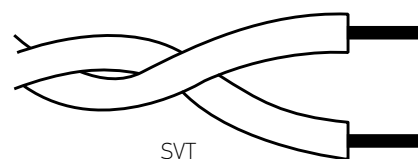

Type de câble | SVT
Fil conducteur tressé, manchon PVC
Isolation simple

CÂBLE TEXTILE TORSADÉ 2 x 0.5mm²

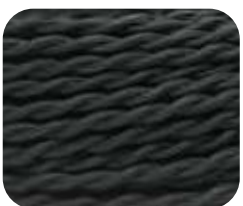

237941



237942

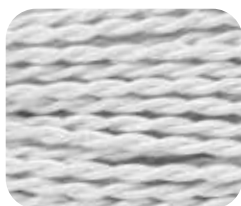

237943



237944

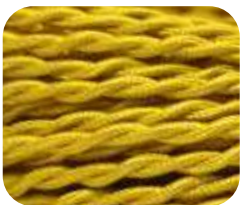

237947



237949

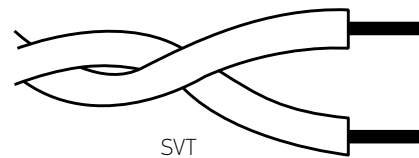

Type de câble | H05V-K
Ø5mm
Isolation simple

CÂBLE TEXTILE TORSADÉ 2 x 0.75mm²



237133



237141



237142



237147



237149

Type de câble | SVT
Fil conducteur tressé, manchon PVC
Isolation simple

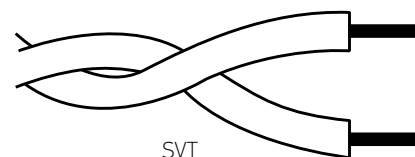

CÂBLE TEXTILE TORSADÉ 3 x 0.5mm²

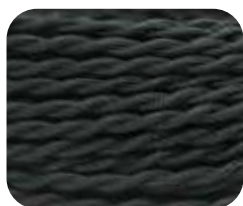

237331

Type de câble | SVT
Fil conducteur tressé, manchon PVC
Isolation simple

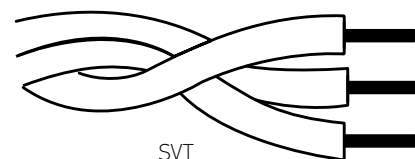

CÂBLE TEXTILE TORSADÉ 3 x 0.75mm²



237457

Type de câble | SVT
Fil conducteur tressé, manchon PVC
Isolation simple

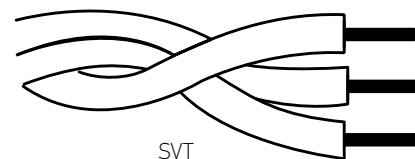



300/
500V



T 70°C



235011



235017



235025

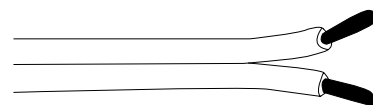

VDE8867

Type de câble | VDE8867 2 x 0.3mm²
Dimensions | Ø1.5 x 3mm

CÂBLE PVC MÉPLAT 2 X 0.5mm²



T 85°C



235147

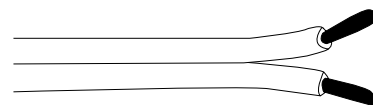

H03 VH-H

Type de câble | H03VH-H
Isolation simple
Ø5.1 x 2.15mm

CÂBLE PVC OVALE 2 x 0.5mm²



T 85°C



236243



236251



236257



236285

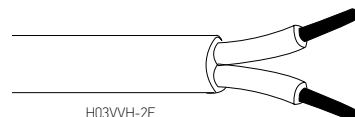

H03VVH-2F

Type de câble | H03VVH-2F
Manchon en PVC,
enveloppe extérieure ronde en PVC
Double isolation
Ø5.2 x 3.2mm

CÂBLE PVC OVALE 2 x 0.75mm²



236373



236381



236387



236398

Type de câble | H03VVH-2F
Manchon en PVC,
enveloppe extérieure ronde en PVC
Double isolation
Ø5.5 x 3.5mm



H03VVH-2F

CÂBLE PVC ROND 2 x 0.75mm²



235833



235841



H03VVF

Type de câble | H03VVF
Manchon en PVC, enveloppe extérieure ronde en PVC
Double isolation
Ø5.4mm

CÂBLE PVC ROND 3 x 0.75mm²

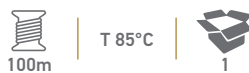

235913



235921



235927



H03VVF

Type de câble | H03VVF
Manchon en PVC,
enveloppe extérieure ronde en PVC
Double isolation
Ø3 x 0,75mm²

CÂBLE UNIFILAIRE 1 x 0.75mm²

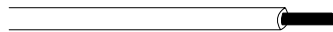

H05VK

235753

Type de câble | H05VK
Conducteurs souples
Isolation simple
Ø2mm

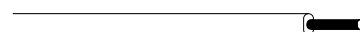

AWG20

236982

Type de câble | AWG20
Finition | Téflon
Câble flexible
Isolation simple
Ø1mm

CÂBLE PVC ROND HAUTE TEMPÉRATURE 3 x 0.75mm²



236527

Type de câble | H03V2V2-F
Double isolation
Ø5.6mm

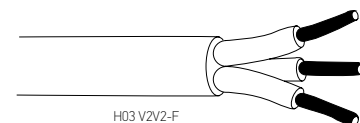

H03 V2V2-F

**236974**

Avant rétraction | 7mm
Après rétraction | 4mm
Cross-section | $1 \times 0.7\text{mm}^2 - 1 \times 0.4\text{mm}^2$
PVC plastifié, manchon thermorétractable, résistance
diélectrique transparente | 20KV/mm
Température de rétraction | 120°C
Isolation simple

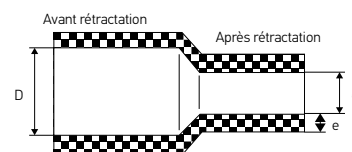





CÂBLES PRÉ-MONTÉS



| | |
|-----------------------|-----|
| CORDON PLASTIQUE..... | 144 |
| CORDON TEXTILE..... | 148 |

CORDON PLASTIQUE FICHE SANS INTERRUPTEUR 2 x 0.75mm² L.1.5m

T 70°C

2.5A
250V



CABLE
EN 50525-2-11 2011
CEI EN 50525-2-11 2012

PLUG
EN50075
IEC60884-1 3rd Ed. '02 A1 2006



241001

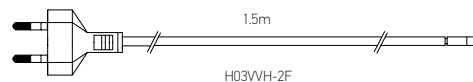

Type de câble | H03VVH-2F
L. 1.5m avec Fiche bipolaire
Accessoire électro-soudés, extrémités serties

CORDON PLASTIQUE FICHE SANS INTERRUPTEUR 2 x 0.75mm² L.2m

T 70°C

2.5A
250V



CABLE
EN 50525-2-11 2011
CEI EN 50525-2-11 2012

PLUG
EN50075
IEC60884-1 3rd Ed. '02 A1 2006



241023



241041



241040

Type de câble | H03VVH-2F
L.2m avec Fiche bipolaire
Accessoire électro-soudés, extrémités serties

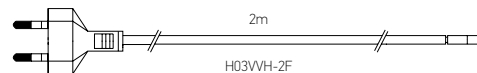

CORDON PLASTIQUE FICHE AVEC INTERRUPTEUR 2 x 0.75mm² L.1.5m



240523



240531



240540



240547

Type de câble | H03VVH-2F
L. 1,5 m avec fiche bipolaire et interrupteur à bascule

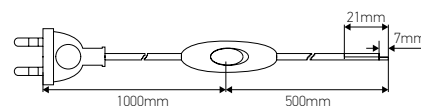

CORDON PLASTIQUE FICHE AVEC INTERRUPTEUR 2 x 0.75mm² L.2m



240573



240581



240580



240587

Type de câble | H03VVH-2F
L. 2 m avec fiche bipolaire et interrupteur à bascule

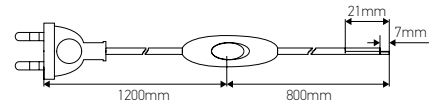

CORDON PLASTIQUE FICHE AVEC INTERRUPTEUR 2 x 0.75mm² L.3m



240511

Type de câble | H03VVH-2F
L. 3m avec bipolaire et interrupteur à bascule

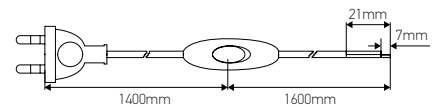

CORDON PLASTIQUE FICHE SANS INTERRUPTEUR 3 x 0.75mm² L.2m



10/16A
250V



241563

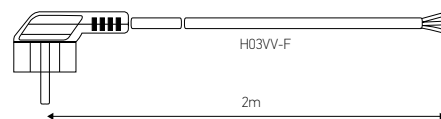

Type de câble | H03VV-F
L.2m avec Euro-Schuko double terre et interrupteur
Extrémités serties

CORDON PLASTIQUE FICHE SANS INTERRUPTEUR 3 x 0.75mm² L. 4m



10/16A
250V



241581

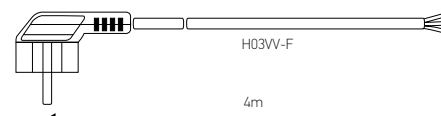

Type de câble | H03VV-F
L.4m avec Euro-Schuko double terre et interrupteur
Extrémités serties

CORDON PLASTIQUE FICHE SANS INTERRUPTEUR 3 x 1mm² L.1.5m



241631

L.2m avec Euro-Schuko terre et interrupteur
Distance entre l'interrupteur et la fiche | 1.20m

CÂBLE AVEC INTERRUPTEUR PIED + FICHE 2 x 0.75mm² L.3.5m



241313



241321



241350

L. 3.5m con interruttore a pedale e spina bipolare
Distance entre l'interrupteur et la fiche | 1m

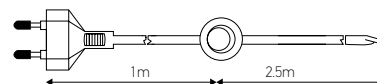

CÂBLE ELECTRIQUE AVEC FICHE + INTERRUPTEUR À PIED 3 x 0.75mm² L. 3.5m



241471

L.3.5m avec Euro-Schuko double terre et interrupteur
Distance entre l'interrupteur et la fiche | 1m

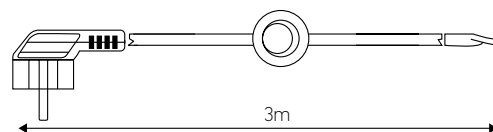

CÂBLES PRÉ-MONTÉS

CORDON PLASTIQUE FICHE AVEC INTERRUPTEUR 3 x 0.75mm² L.2m



241451



241467

L.2m avec Euro-Schuko terre et interrupteur
Distance entre l'interrupteur et la fiche | 1.20m

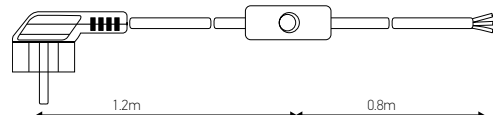

CORDON TEXTILE AVEC FICHE + INTERRUPTEUR TRANSPARENT 2 x 0.75mm² L. 2m



241611



241633



241634



241635



241636



241638



241639

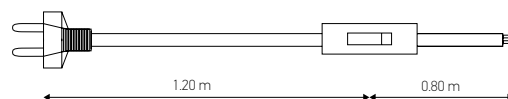

Type de câble | H03VVH2-F
L.2m avec interrupteur à bascule et fiche bipolaire
Distance entre l'interrupteur et la fiche | 1.20m

CORDON AVEC VARIATEUR POUR LED ET HALOGENE 2 x 0.75mm² L.2m



V. AC
100-240V
50/60Hz



260011

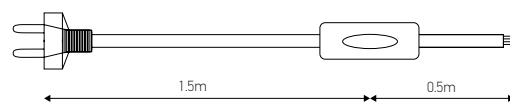

L. 2 m avec fiche bipolaire et variateur
Distance entre l'interrupteur et la prise | 1.50m
Convient aux LED
Gamme de puissance | Halo 40/160W, LED 4/100W

CÂBLE AVEC FICHE + VARIATEUR HALOGENE 2 x 0.75mm² L. 2m

2.5A
250V



261122



261137



261133

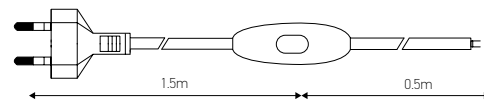

L. 2 m avec fiche bipolaire et variateur
Distance entre l'interrupteur et la prise | 1.50m
Gamme de puissance | Halo 40/160W, LED 4/100W



FICHES

| | |
|---------------------------------|-----|
| FICHES MÂLE | 152 |
| FICHES BIPOLAIRE | 152 |
| FICHE FEMELLE SOCLE MOBILE..... | 153 |
| FICHE À COIFFE MÂLE..... | 153 |



FICHE MÂLE



250554



250555



250556



250557

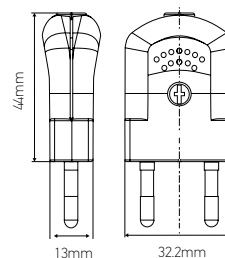

Câble à utiliser | H03VV-F, H05VV-F,
H03VH2-F
Bornes à vis

FICHE BIPOLAIRE + TERRE



250893



250891



250897

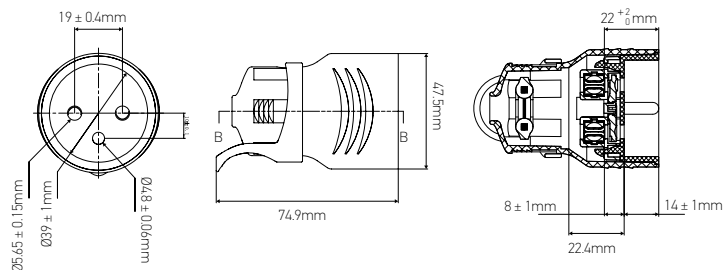

Câble à utiliser | 0.75 - 1.5mm²



250887

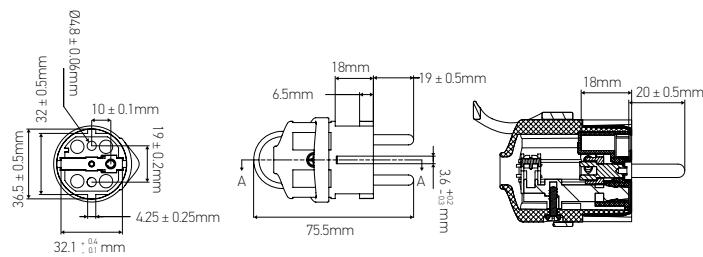

Câble à utiliser | 0.75 - 1.5mm²



250781



250786

Broches | Ø4,8mm
Avec éclipses de protection

SOCLE MOBILE À SORTIE DROITE FICHE FEMELLE

IEC 60598-1 : 2015
IEC 60598-2-1



250784



250785

16A 2P+T
Type de produit | Fiches de courant
Matériaux | Plastique
Pour câble Ø maxi. | 11mm
Ø42 x 69mm

FICHE À COIFFE AVEC ANNEAU FICHE MÂLE

IEC 60598-1 : 2015
IEC 60598-2-1



250787



250788

16A 2P+T
Type de produit | Fiches de courant
Matériaux | Plastique
44 x 36 x 59mm



INTERRUPTEURS

| | |
|-----------------|-----|
| DÉCO..... | 156 |
| CLASSIQUES..... | 158 |

INTERRUPTEUR BIPOLAIRE

EN 61058



155733



155735



EN 61058



155463



155731

Type | À main
Bornes à vis
Câble à utiliser | H03VVH2-F
Pour câble transparent plat ou rond 2 x 0.75 mm²
60 x 26 x 15mm

INTERRUPTEUR AVEC TERRE

EN 61058



155736



155737



155738

Art | À main
Bornes à vis
Câble à utiliser | H03VVH2-F
Pour câble plat 2 x 0.75mm² et câble rond 2 x 0.75mm² et 3 x 0.75mm²
60 x 26 x 15mm

INTERRUPTEUR CURSEUR

EN 61058-1



246751



246763

Art | À main
Interrupteur à curseur
Contacts laiton
Bornes à vis
Câble à utiliser | H03VVH2-F
For 2 x 0.75mm² - Connexion pour neutre

INTERRUPTEUR BIPOLAIRE À BASCULE

EN 61058-1



246941
avec terre



246953
avec terre

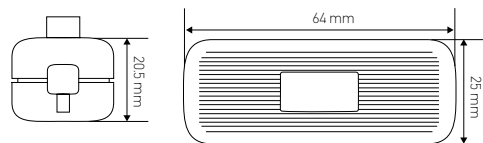

Art | À main
Contacts laiton
Bornes à vis
Boîtier clipsable
Câble à utiliser | H03VVH

INTERRUPTEUR POUSSOIR



245115
montage automatique



245209
montage à vis

EN 61058-1:2002
EN 61058-1:2002/A2:2008
EN 61058-1-1:2016
EN50581: 2012



245695

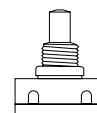

CONTRE ÉCROU
Acier décapé
Ø12.3mm

Type | À main
Bornes à vis
24,2 x 12 x 9,7mm

BAGUE CONIQUE POUR INTERRUPTEUR À POUSSOIR



245457



245465

Laiton
Laiton nickelé

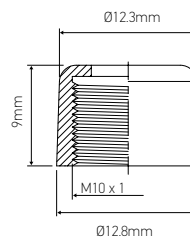

245443

Polystyrene
Hauteur | 7mm
Contacts en bronze - Bornes à pousser
24,2 x 12 x 19mm

EN 61058-1
UL 1054
CSA C22.2

INTERRUPTEUR UNIPOLAIRE À BASCULE FIXATION PAR CLIPSAGE ET BORNES À VIS

EN 61058-1

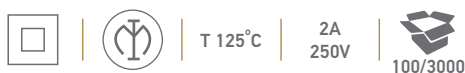

245801



245803

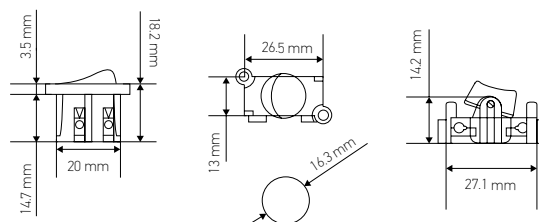

Type | À encastrer
Plaque à 2 trous

INTERRUPTEUR UNIPOLAIRE DOUBLE ALLUMAGE



245824

INTERRUPTEURS

INTERRUPTEUR UNIPOLAIRE À BASCULE FIXATION PAR VIS ET BORNES À SERTIR

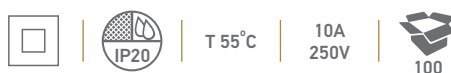

245821



245823

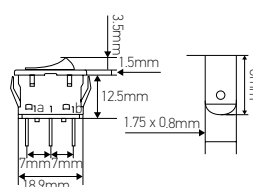

INTERRUPTEUR À PIED AVEC TERRE Ø65mm



2A
250V



246051



246063



246077



246088

Art | À pied
Bornes à vis
Câble à utiliser | H03VV-F
Pour câbles ronds | 3 x 0.75mm²
Serre-câble | par une plaque plastique et deux vis
(Ø x H) | Ø65 x 23mm



INTERRUPTEUR «TUMBLER» AVEC BAGUE MOLETÉE ET CONTRE-ÉCROU



247325

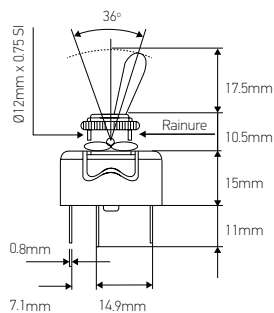

Art | À main
15A / 250Vca _ 12Vcc
Bague moletée & écrou de blocage int. Ø12mm va et vient possible

INTERRUPTEUR UNIPOLAIRE À TIRETTE



EN 61058-1



245795

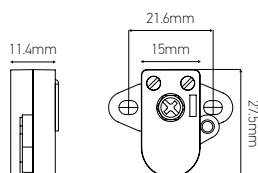

Art | Borne à vis
Plaque à 2 trous
27,5 x 15 x 11,4mm

CONTACTEUR DE MEUBLE



NF C-61314
REACH



247763

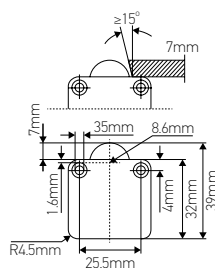

Contact par molette



VARIATEURS

| | |
|---------------------------------|-----|
| VARIATEUR À MAIN | 164 |
| VARIATEUR À PIED | 164 |
| VARIATEUR ROTATIF À MAIN | 165 |
| VARIATEUR UNIVERSEL À PIED..... | 165 |

VARIATEUR À MAIN LED / HALOGÈNE



260001



260002



260003



260007

Pour halogène et LED
Régulation continue
Démarrage et arrêt progressifs
Câble à utiliser | H03VV-F
Halogène | 25÷160W (220-240V~ - 50/60Hz) - 25÷80W (110-127V~ - 50/60Hz)
LED | 4÷25W (220-240V~ - 50/60Hz) - 4÷25W (110-127V~ - 50/60Hz)

VARIATEUR À MAIN LED



158852

Pour LED
1-20W
Bouton poussoir intégré
70 x 28,8 x 18,1mm

VARIATEUR LED À PIED



158860

LED | 1 - 85W
Bouton poussoir intégré
Ø65 x 31,2mm

VARIATEUR ROTATIF À MAIN POUR LED / HALOGENE



158858

10-150W Inc
11-75W CFL
4-60W LED
Variateur universel à main
97 x 30,5 x 28,5mm

VARIATEUR UNIVERSEL À PIED AVEC CURSEUR



260723



260721



260727

Halogène 40-250W, LED 4-100W
Technologie de pointe
Indicateur lumineux
115 x 71 x 39mm



260821

Halogène 40-250W, LED 4-100W
Technologie de pointe
109 x 61 x 33mm



PRISES INTERRUPTEURS MURAUX ET MULTIPRISES

| | |
|---------------------------|-----|
| PRISES MURALES | 168 |
| INTERUPTEURS MURAUX | 169 |
| MULTIPRISES..... | 171 |



16A
250V



NOUVEAUTÉ



200606



200607

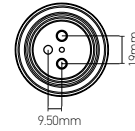
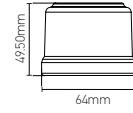

Raccordement à vis par 4

PRISE AVEC TERRE PORCELAINE



16A
250V



200604



200605

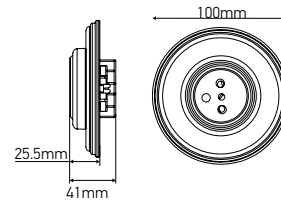

Ne dispose pas de raccordement avec terre mais fonctionne en va-et-vient.
Raccordement à vis par 4





200600



200601

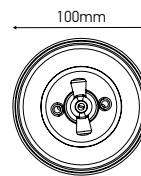
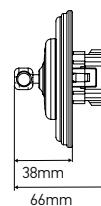

Ne dispose pas de raccordement avec terre mais fonctionne en va-et-vient.
Prêt à monter.
Raccordement à vis par 4

INTERRUPTEUR POSE EN SAILLIE PORCELAINE



200602



200603

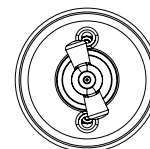
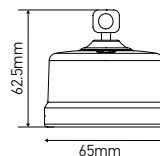

Dispose du raccordement avec terre.
Raccordement à vis par 4



V-PRO VARIATEUR MURAL LED

CE | 1-120W | V. AC
220-250V



320000



320001

86 x 86 x 48mm





252111

Nombre de prises | 6
Pré-câblé
Avec câble | H05VV-F 3G 1.0mm²
Max watt | 3680W 250V ~ 50Hz

BLOC MULTIPRISES



158705
4 prises



COMPOSANTS LUSTRERIE

TOUTE LA PETITE QUINCAILLERIE 174

BÉLIÈRE



281492

| Réf. | Matériau | Dim. H _{mm} |
|--------|----------------------|----------------------|
| 281492 | acier découpé zingué | 34mm |

Avec vis de blocage et borne de mise à la terre

BAGUE COULISSANTE



281836

| Réf. | Matériau | Dim. Ø _{mm} |
|--------|----------|----------------------|
| 281836 | laiton | Ø11mm |

Avec vis d'arrêt pour tube Ø10/11mm

TUBE POUR PAVILLON



282027



282039



282049



282171

| Réf. | Matériau | Filetage | Dim. Ø x L _{mm} |
|--------|---------------|-------------|--------------------------|
| 282027 | laiton décapé | mâle 10 x 1 | Ø10 x 70mm |
| 282039 | laiton décapé | mâle 10 x 1 | Ø10 x 90mm |
| 282049 | laiton patiné | mâle 10 x 1 | Ø10 x 90mm |
| 282171 | laiton chromé | mâle 10 x 1 | Ø10 x 90mm |

CHAÎNES FIGARO, NON SOUDÉE

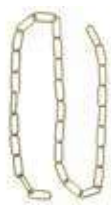

285664

| Réf. | Matériau | Maillons | Épaisseur du fil | Dim. |
|--------|---------------|----------|------------------|------|
| 285664 | acier laitoné | 34mm | Ø2.8mm | 1m |

CHAÎNE OVALES



286230

| Réf. | Matériau | Maillons | Épaisseur du fil | Dim. |
|--------|---------------|----------|------------------|------|
| 286230 | acier laitoné | 30mm | Ø3.2mm | 1m |



ANNEAUX



287372



287594

| Réf. | Matériau | Filetage | ⊖ Ø x H _{mm} |
|---------------|----------|----------------|-----------------------|
| 287372 | laiton | mâle 10 x 1 | 26 x 35 |
| 287594 | laiton | femelle 10 x 1 | 27 x 42 |

Mobile, raccord mâle 10 x 1, poids supporté 1kg



287605

| Réf. | Matériau | Filetage | ⊖ Ø x H _{mm} |
|---------------|--------------|----------------|-----------------------|
| 287605 | laiton fondu | femelle 10 x 1 | 27 x 15 |



288272

| Réf. | Matériau | Filetage | ⊖ Ø x H _{mm} |
|---------------|--------------|----------------|-----------------------|
| 288272 | laiton fondu | femelle 10 x 1 | - |

TUBE LISSE



300825

| Réf. | Matériau | Filetage | Ømm x Lm |
|--------|----------|--------------------|----------|
| 300825 | laiton | tube de couverture | Ø12 x 1m |

Diamètre intérieur | Ø11mm
Diamètre extérieur | Ø12mm

TUBE FILETÉ



302195

| Réf. | Matériau | Filetage | Ø x Lmm |
|--------|----------|-------------------------|---------|
| 302195 | laiton | pas international 8 x 1 | Ø8 x 20 |

TUBULURE FILETÉE



300369



300370

| Réf. | Matériau | Filetage | Ø _{mm} x L _m |
|--------|--------------|--------------------------|----------------------------------|
| 300369 | laiton | pas international 10 x 1 | Ø10 x 1m |
| 300370 | acier zingué | pas international 10 x 1 | Ø10 x 1m |



300382

| Réf. | Matériau | Filetage | Ø _{mm} x L _m |
|--------|--------------|--------------------------|----------------------------------|
| 300382 | acier zingué | pas international 10 x 1 | Ø10 x 2m |

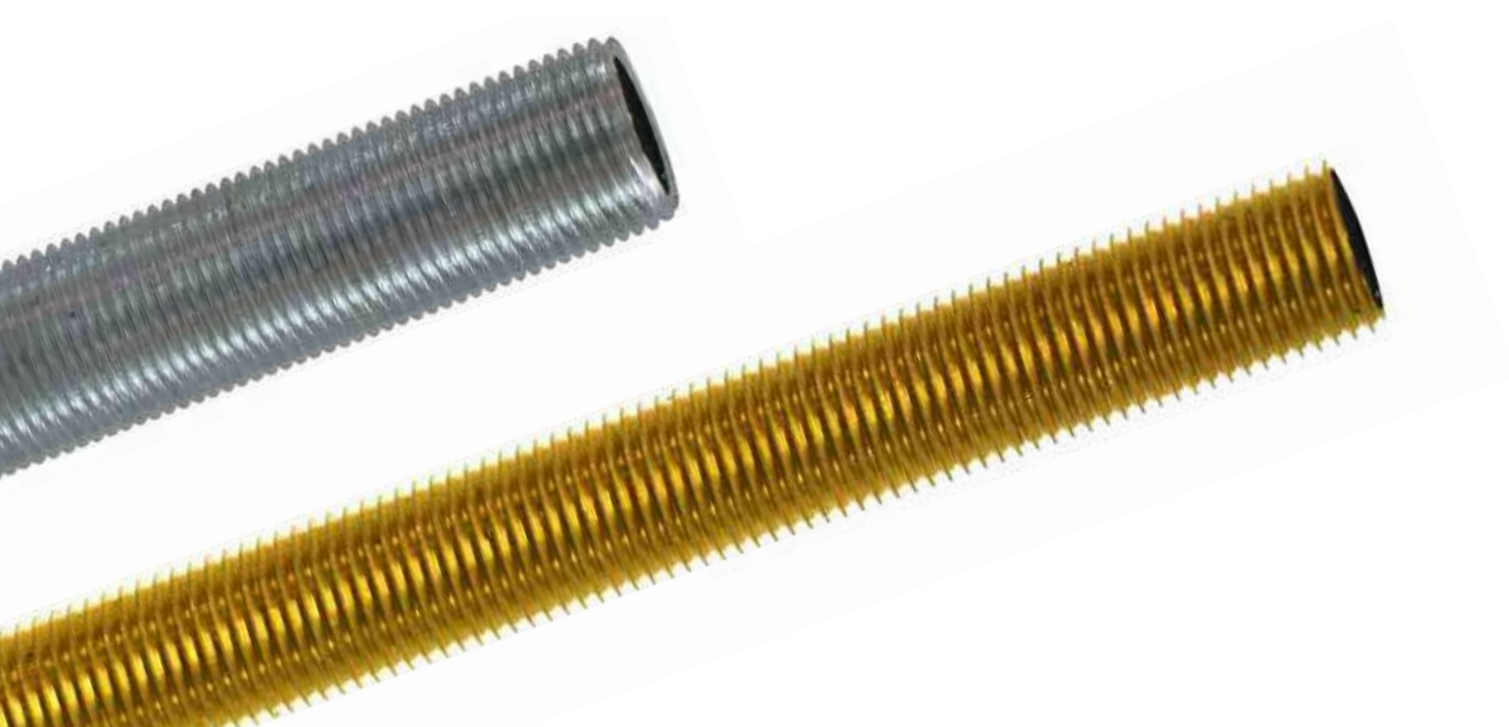

TUBULURE FILETÉE



Pas International 10 x 1

| Réf. | Length |  |
|--------|--------|---|
| 302257 | 10mm | 100 |
| 302279 | 15mm | 100 |
| 302281 | 20mm | 100 |
| 302292 | 25mm | 100 |
| 302303 | 30mm | 100 |
| 302314 | 35mm | 100 |
| 302325 | 40mm | 100 |
| 302336 | 45mm | 100 |
| 302347 | 50mm | 100 |

| Réf. | Length |  |
|--------|--------|---|
| 302448 | 100mm | 500 |
| 302460 | 120mm | 500 |
| 302471 | 130mm | 500 |
| 302482 | 140mm | 500 |
| 302493 | 150mm | 500 |
| 302537 | 190mm | 500 |
| 302548 | 200mm | 500 |
| 302551 | 300mm | 500 |



302598



302554

| Réf. | Matériau | Filetage | Ømm x Lmm |
|--------|--------------|--------------------------------------|-----------|
| 302598 | acier zingué | pas international 10 x 1 avec méplat | Ø10 x 50 |
| 302554 | acier zingué | pas international 10 x 1 avec méplat | Ø10 x 15 |

Internal Ø | 27mm



302643

| Réf. | Matériau | Filetage | Ømm x Lmm |
|--------|--------------|--------------------------|-----------|
| 302643 | acier zingué | pas International 13 x 1 | Ø13 x 50 |

BORNES DE MISE À LA TERRE POUR DOUILLE



231905

| Réf. | Épaisseur | Trou | Largeur | Longueur |
|--------|-----------|---------|---------|----------|
| 231905 | 0.9mm | Ø10.5mm | 15mm | 30mm |

ECROU 6 PAN



303121



303598



303619



303620



303675



331972

| Réf. | Matériau | Filetage | Ø _{mm} x L _{mm} |
|--------|----------------------|--------------------------|-----------------------------------|
| 303121 | laiton décollété | écrou pas de bec | Ø11 x épaisseur 2 SP14 |
| 303598 | laiton décollété | pas international 10 x 1 | épaisseur 2 SP14 |
| 303619 | acier découpé zingué | pas international 10 x 1 | épaisseur 2.5mm SP14 |
| 303620 | acier découpé zingué | pas international 10 x 1 | épaisseur 4mm SP14 |
| 303675 | acier zingué | pas international 8 x 1 | épaisseur 4mm SP11 |
| 331972 | laiton | filetage 4 x 70 | épaisseur 3mm SP7 |

RACCORD FIN DE LUSTRE



309610



309721



309732

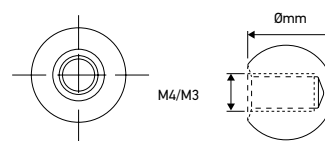

| Réf. | Matériau | Filetage | Ø mm |
|--------|----------|----------------|------|
| 309610 | laiton | femelle 3 x 50 | Ø8 |
| 309721 | laiton | femelle 4 x 70 | Ø10 |
| 309732 | laiton | femelle 4 x 70 | Ø14 |

BOULE À TIGE



309765

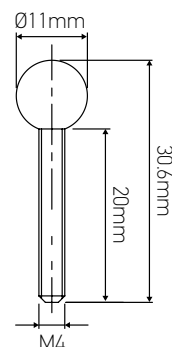

| Réf. | Matériau | Filetage | Ø x Hmm |
|--------|----------|-------------------------|----------|
| 309765 | laiton | femelle filetage 4 x 70 | Ø11 x 20 |

COMPOSANTS LUSTRIERIE

GLAND



331728

| Réf. | Matériau | Filetage |
|--------|----------|-----------------------------|
| 331728 | laiton | sans embase, femelle 4 x 70 |

EMBASE



331840

| Réf. | Matériau | Filetage |
|--------|----------|-----------------------------|
| 331840 | laiton | mâle 10 x 1, femelle 4 x 70 |

FILET DÉCOLLETÉ



331951

| Réf. | Matériau | Filetage | Lmm |
|--------|----------|------------------------|-----|
| 331951 | laiton | filet décolleté 4 x 70 | 15 |

RONDELLE FILETÉE



303731



303842

| Réf. | Matériau | Filetage | Ømm x Lmm |
|--------|----------|---------------|-----------------------|
| 303731 | laiton | raccord 10 x1 | Ø13 x épaisseur : 2.5 |
| 303842 | laiton | raccord 10 x1 | Ø20 x épaisseur : 20 |

RONDELLE CRANTÉE



304894

| Réf. | Matériau | Filetage | Ømm x Lm |
|--------|--------------|--------------|----------|
| 304894 | acier zingué | raccord 10.5 | Ø18 |

RONDELLE



304126



304237



304783



304561

| Réf. | Matériau | Trou | Ømm x Lm |
|--------|--------------|-------|-------------------------|
| 304126 | laiton | Ø11 | Ø24 x épaisseur : 1 |
| 304237 | laiton | Ø11 | Ø18 x épaisseur : 1 |
| 304783 | acier traité | Ø11 | Ø17.3 x épaisseur : 1.5 |
| 304561 | acier zingué | Ø10.5 | Ø40 x épaisseur : 1 |

Rondelle «Grower»

RONDELLE PVC



304905



304916



304927



304938

| Réf. | Matériau | Épaisseur mm | Trou mm | Ømm |
|--------|----------|--------------|---------|-----|
| 304905 | PVC | 2 | Ø10.2 | Ø14 |
| 304916 | PVC | 2 | Ø10.2 | Ø22 |
| 304927 | PVC | 2 | Ø10.2 | Ø31 |
| 304938 | PVC | 2 | Ø13.5 | Ø51 |

RACCORD MÂLE 6 PANS À PORTÉE

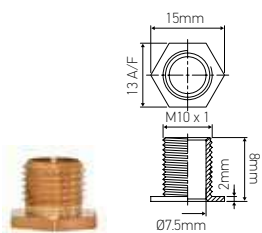

305421

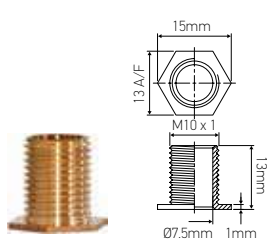

305467

| Réf. | Matériau | Filetage | H _{mm} |
|--------|----------|--------------------------|-----------------|
| 305421 | laiton | pas international 10 x 1 | 8 |
| 305467 | laiton | pas international 10 x 1 | 13 |

RACCORD MÂLE À PORTÉE

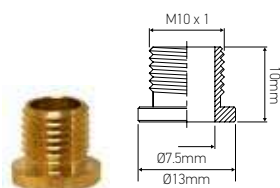

305478

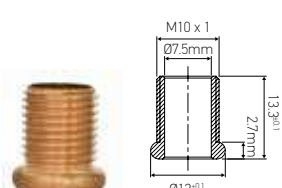

305590



305944

| Réf. | Matériau | Filetage | Ø x H _{mm} |
|--------|----------|----------------------------|---------------------|
| 305478 | laiton | raccord mâle 10 x 1 | Ø13 x 10 |
| 305590 | laiton | raccord mâle 10 x 1 | Ø12 x 13 |
| 305944 | laiton | double raccord mâle 10 x 1 | Ø14 x 15 |

RACCORD DOUBLE FEMELLE

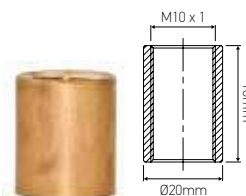

306340



306359



306574

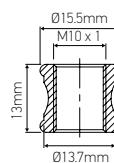

| Réf. | Material | Thread |
|--------|---------------|--------------------------|
| 306340 | laiton | pas de Paris 16,85mm |
| 306359 | laiton chromé | pas international 10 x 1 |
| 306574 | laiton | pas international 10 x 1 |

RACCORD DOUBLE FEMELLE

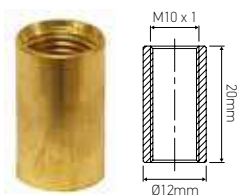

306351



306362

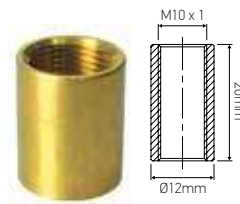

306473

| Réf. | Matériau | Filetage | Ø x H _{mm} |
|--------|----------|--|---------------------|
| 306351 | laiton | pas international 10 x 1 | Ø12 x 20 |
| 306362 | laiton | pas international avec vis de blocage 10 x 1 | Ø14 x 15 |
| 306473 | laiton | pas international 13 x 1 | Ø16 x 20 |

RACCORD MÂLE ET FEMELLE

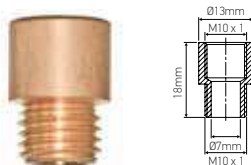

306796

| Réf. | Matériau | Filetage | Ø x H _{mm} |
|--------|---------------|--------------------------|---------------------|
| 306796 | laiton chromé | pas international 10 x 1 | Ø13 x 18 |

RACCORD À SOUDER

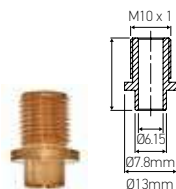

306929

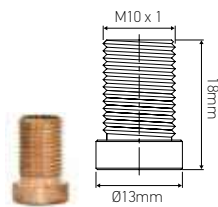

306930

| Réf. | Matériau | Filetage | Description | Ø x H _{mm} |
|--------|----------|--------------------------|--------------------|---------------------|
| 306929 | laiton | pas international 10 x 1 | avec enclavage 8mm | Ø13 x 18 |
| 306930 | laiton | pas international 10 x 1 | pour tube Ø8mm | Ø13 x 18 |

RACCORD DE RÉDUCTION

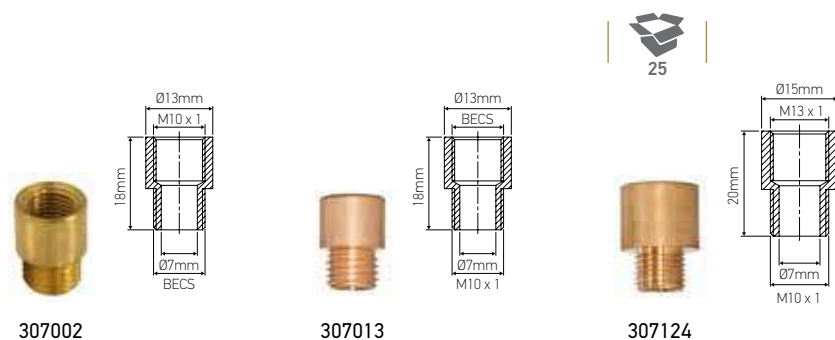

| Réf. | Matériau | Filetage | Ø x H _{mm} |
|--------|----------|--|---------------------|
| 307002 | laiton | mâle becs (10,85 x 1,33), femelle 10 x 1 | Ø13 x 18 |
| 307013 | laiton | femelle becs (10,85 x 1,33), mâle 10 x 1 | Ø13 x 18 |
| 307124 | laiton | femelle becs 13 x 1, mâle 10 x 1 | Ø15 x 20 |

RACCORD ÉTRIER



| Réf. | Matériau | Filetage | Ø x H _{mm} |
|--------|----------|--|---------------------|
| 307346 | laiton | raccord double femelle 10 x 1 avec vis d'arrêt | Ø14 x 20 |
| 307350 | laiton | raccord double femelle 10 x 1 avec vis d'arrêt | Ø18 x 20 |
| 307902 | laiton | mâle 10 x 1, femelle 8 x 1 | Ø13 x 10 |

RACCORD À LAME



| Réf. | Matériau | Filetage | Ecartement mm | Trou mm | L x W x H _{mm} |
|--------|--------------|---------------------|---------------|---------|-------------------------|
| 308136 | acier zingué | raccord mâle 10 x 1 | 38 | Ø4 | 54 x 17 x 8 |
| 308147 | acier zingué | raccord mâle 10 x 1 | 38 | Ø10 | 54 x 17 x 13 |

RACCORD À PLAQUE 2 TROUS



308470



308482

| Réf. | Matériau | Filetage | Ecartement mm | Trou mm | Ø x H mm |
|---------------|---------------|-------------|---------------|---------|----------|
| 308470 | laiton | mâle 10 x 1 | 17 | Ø3 | Ø25 x 9 |
| 308482 | laiton chromé | mâle 10 x 1 | 17 | Ø3 | Ø25 x 9 |



308692



308702



308713

| Réf. | Matériau | Filetage | Ecartement mm | Trou mm | Ø x H mm |
|---------------|---------------|----------------|---------------|---------|----------|
| 308692 | laiton | mâle 10 x 1 | 17 | Ø3 | Ø40 x 9 |
| 308702 | laiton chromé | mâle 10 x 1 | 17 | Ø3 | Ø40 x 7 |
| 308713 | laiton | femelle 10 x 1 | 17 | Ø3 | Ø40 x 7 |

RACCORD ÉQUERRE



309007

| Réf. | Matériau | Filetage | Dim. mm |
|---------------|----------|---------------------------------------|---------|
| 309007 | laiton | boule à portée, double femelle 10 x 1 | Bas Ø18 |



309420



309431

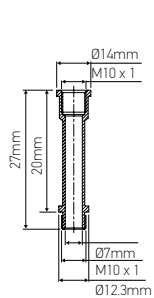

309420

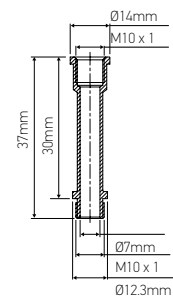

309431



309442



309453



309464

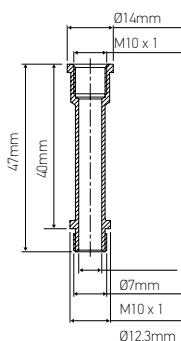

309442

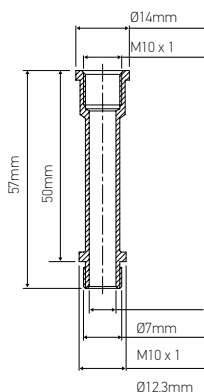

309453

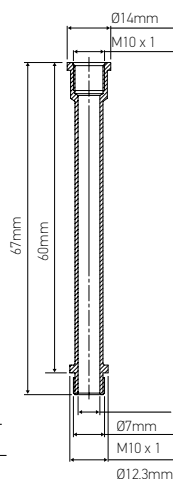

309464



309475



309486



309497



309509

| Réf. | Matériau | Filetage | Bas Ø x L _{mm} |
|--------|----------------|------------------------|-------------------------|
| 309420 | laiton décollé | mâle et femelle 10 x 1 | Ø14 x 20 |
| 309431 | laiton décollé | mâle et femelle 10 x 1 | Ø14 x 30 |
| 309442 | laiton décollé | mâle et femelle 10 x 1 | Ø14 x 40 |
| 309453 | laiton décollé | mâle et femelle 10 x 1 | Ø14 x 50 |
| 309464 | laiton décollé | mâle et femelle 10 x 1 | Ø14 x 60 |
| 309475 | laiton décollé | mâle et femelle 10 x 1 | Ø14 x 70 |
| 309486 | laiton décollé | mâle et femelle 10 x 1 | Ø14 x 80 |
| 309497 | laiton décollé | mâle et femelle 10 x 1 | Ø14 x 100 |
| 309509 | laiton décollé | mâle et femelle 10 x 1 | Ø14 x 120 |



310127

| Réf. | Matériau | Filetage | Ø x Hmm |
|--------|----------|-------------------------|------------|
| 310127 | laiton | femelle filetage 10 x 1 | Ø16 x 20mm |



CHANDELLE



310012



310034

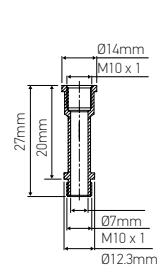

310012

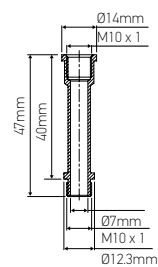

310034



310078



310089

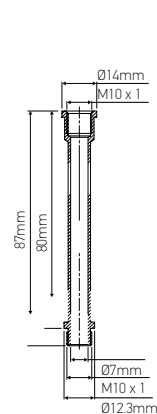

310078

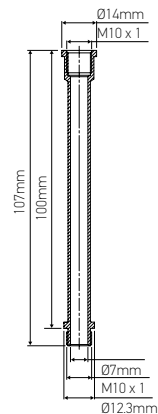

310089

| Réf. | Matériau | Filetage | Base Ø x L _{mm} |
|--------|---------------|------------------------|--------------------------|
| 310012 | laiton chromé | mâle et femelle 10 x 1 | Ø14 x 20 |
| 310034 | laiton chromé | mâle et femelle 10 x 1 | Ø14 x 40 |
| 310078 | laiton chromé | mâle et femelle 10 x 1 | Ø14 x 80 |
| 310089 | laiton chromé | mâle et femelle 10 x 1 | Ø14 x 100 |

RONDELLE FILETÉE



320486

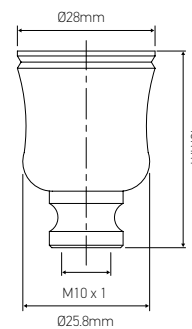

| Réf. | Matériau | Filetage | Ø x H _{mm} |
|--------|----------|----------------|---------------------|
| 320486 | laiton | femelle 10 x 1 | Ø28 x 41 |

CACHE-DOUILLE



320596

| Réf. | Matériau | Pour douille | Trou | Ø x H _{mm} |
|--------|----------|--------------|-------|---------------------|
| 320596 | laiton | E27 | Ø10,2 | Ø40,5 x 35 |

CACHE-DOUILLE 1/2 SPHÈRE



320719

| Réf. | Matériau | Ø x H _{mm} |
|--------|-------------------|---------------------|
| 320719 | laiton poli verni | Ø39 x 19 |

COUPELLE



321626

| Réf. | Matériau | Trou mm | Dim. Ø _{mm} |
|--------|----------|---------|----------------------|
| 321626 | laiton | Ø11 | Ø100 |

RALLONGE



330573



330215



330237

| Réf. | Matériau | Filetage | Ø x H _{mm} |
|--------|-------------------|------------------------|---------------------|
| 330573 | laiton poli verni | mâle et femelle 10 x 1 | Ø13 x 47mm |
| 330215 | laiton chromé | mâle et femelle 10 x 1 | Ø13 x 47mm |
| 330237 | laiton chromé | mâle et femelle 10 x 1 | Ø12,1 x 80mm |



330359



330697

| Réf. | Matériau | Filetage | Ø x H _{mm} |
|--------|-------------------|------------------------|---------------------|
| 330359 | laiton chromé | mâle et femelle 10 x 1 | Ø9,1 x 250 |
| 330697 | laiton poli verni | mâle et femelle 10 x 1 | Ø9,1 x 300mm |

TUBE RALLONGE COULISSANT



330719

| Réf. | Matériau | Filetage | Description |
|--------|-------------------|-------------|--|
| 330719 | laiton poli verni | mâle 10 x 1 | partie fixe Ø10mm, partie coulissant Ø8mm coulissant de 180 à 300mm |

BOÎTE NOURRICE



335715
2 sorties



335726
3 sorties

| Réf. | Matériau | Filetage | Trou mm | Ømm |
|--------|----------|-------------------------------|---------|-----|
| 335715 | laiton | 2 nipples raccord mâle 10 x 1 | Ø8,2 | Ø40 |
| 335726 | laiton | 3 nipples raccord mâle 10 x 1 | Ø8,2 | Ø40 |

PINCE



336501

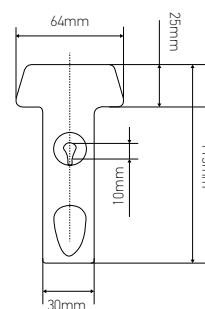

| Réf. | Matériau | Livree |
|--------|----------|----------|
| 336501 | nylon | démontée |

ROTULES



337724

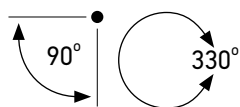

| Réf. | Matériau | Filetage | Force | Ø x Hmm |
|--------|---------------|--|-------|----------|
| 337724 | laiton chromé | bras mâle 8 x 1 articulé 90° rotation 360° avec blocage raccord femelle 8 x 1 pas international | 3kg | Ø13 x 32 |

ROTULE



337009



337020

| Réf. | Matériau | Filetage | Force | Ø _{mm} |
|---------------|---------------|---|-------|-----------------|
| 337009 | laiton | mâle et femelle 10 x 1 rotation 360° avec blocage pas international | 6kg | Ø16 x 38 |
| 337020 | laiton chromé | mâle et femelle 10 x 1 rotation 360° avec blocage pas international | 6kg | Ø16 x 38 |



337010



337034

| Réf. | Matériau | Filetage | Force | Ø x H _{mm} |
|---------------|---------------|---|-------|---------------------|
| 337010 | laiton chromé | raccord femelle 10 x 1 avec vis d'arrêt bras mâle 10 x 1 articulé 90° rotation 360° avec blocage pas international | 5kg | Ø16 x 51 |
| 337034 | laiton | raccord femelle 10 x 1 avec vis d'arrêt bras mâle 10 x 1 articulé 90° rotation 360° avec blocage pas international | 5kg | Ø16 x 51 |

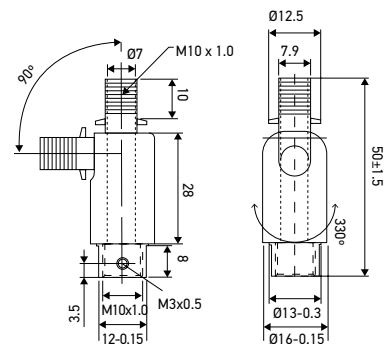

337132



| Réf. | Matériau | Filetage | Force | Ø x H _{mm} |
|---------------|---------------|---|-------|---------------------|
| 337132 | laiton chromé | raccord femelle 10 x 1 avec vis d'arrêt bras mâle 10 x 1 articulé 90° rotation 360° avec blocage pas international | 14kg | Ø16 x 57.5 |

ROTULE



336674

336785

336907



| Réf. | Matériau | Filetage | Ø x H _{mm} |
|--------|---------------|---|---------------------|
| 336674 | laiton | mâle et femelle rotule réglable par clé pas international | Ø19 x 23 |
| 336785 | laiton | mâle et femelle rotule réglable par clé pas international | Ø19 x 34 |
| 336907 | laiton chromé | double femelle rotule réglable par clé pas international | Ø13.5 x 35.5 |

RACCORD PASSAGE DE CÂBLE

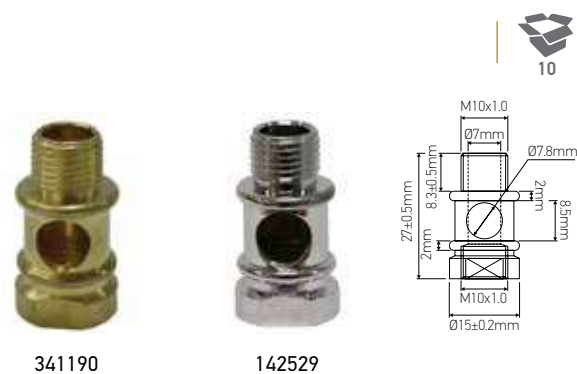

341190

142529

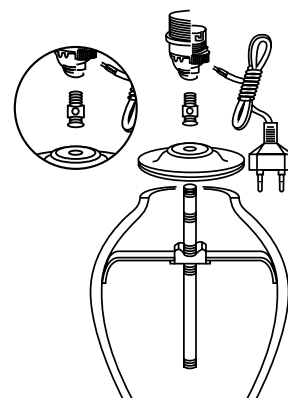

| Réf. | Matériau | Filetage | Hauteur mm |
|--------|--------------|------------------------|------------|
| 341190 | laiton | mâle et femelle 10 x 1 | 27 |
| 142529 | métal chromé | mâle et femelle 10 x 1 | 27 |

BILAME



341012

341056

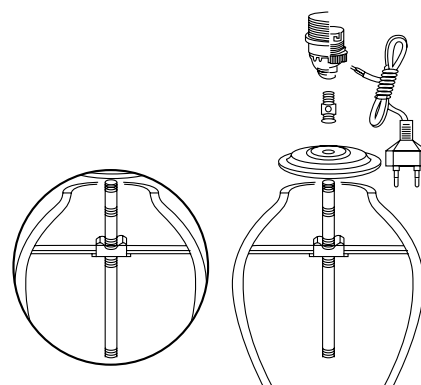

| Réf. | Filetage | Ecartement mm | Ø x H _{mm} |
|--------|---|---------------|---------------------|
| 341012 | fileté 10 x 1, avec lames articulées trou latéral pour fil | 80 | Ø19 |
| 341056 | fileté 10 x 1, avec lames articulées trou latéral pour fil | 150 | Ø16 |

LAME RIGIDE



341212



341234

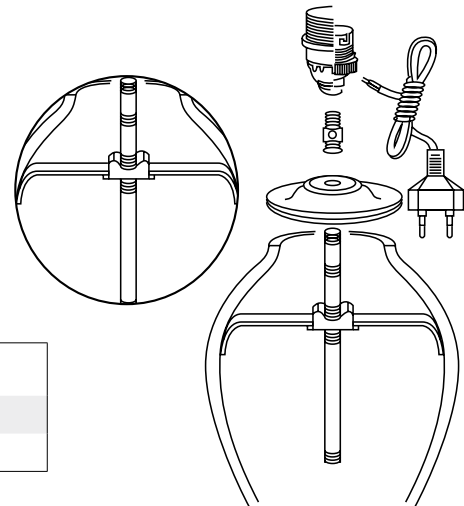

| Réf. | Matériau | Filetage | Ecartement mm |
|---------------|----------------|----------------|---------------|
| 341212 | acier laitonné | femelle 10 x 1 | 80 |
| 341234 | acier laitonné | femelle 10 x 1 | 110 |

PNEU

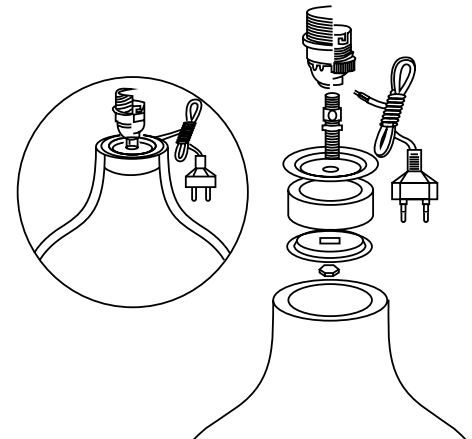
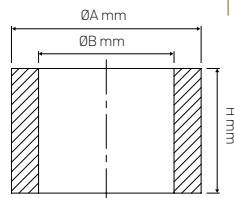

| Réf. | ØA | ØB | H |
|---------------|-------|-------|------|
| 340017 | Ø35mm | Ø25mm | 23mm |
| 340039 | Ø40mm | Ø30mm | 23mm |
| 340051 | Ø45mm | Ø35mm | 23mm |
| 340073 | Ø50mm | Ø40mm | 23mm |
| 340095 | Ø55mm | Ø45mm | 23mm |
| 340137 | Ø60mm | Ø50mm | 23mm |

| Réf. | ØA | ØB | H |
|---------------|-------|-------|------|
| 340159 | Ø65mm | Ø55mm | 23mm |
| 340171 | Ø70mm | Ø60mm | 23mm |
| 340193 | Ø75mm | Ø65mm | 23mm |
| 340215 | Ø80mm | Ø70mm | 23mm |
| 340237 | Ø85mm | Ø75mm | 23mm |

TALON EXTENSIBLES

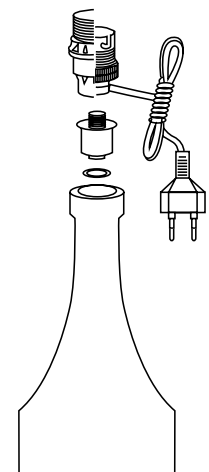
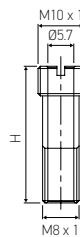

| Réf. | Fitting Ø | H mm |
|---------------|-----------|------|
| 342142 | 12 - 13 | 23 |
| 342164 | 14 - 15 | 23 |
| 342186 | 16 - 18 | 25 |
| 342208 | 19 - 21 | 28 |

| Réf. | Fitting Ø | H mm |
|---------------|-----------|------|
| 342230 | 22 - 24 | 28 |
| 342252 | 25 - 28 | 28 |
| 342274 | 29 - 32 | 28 |
| 342296 | 33 - 36 | 28 |

TALON



342020

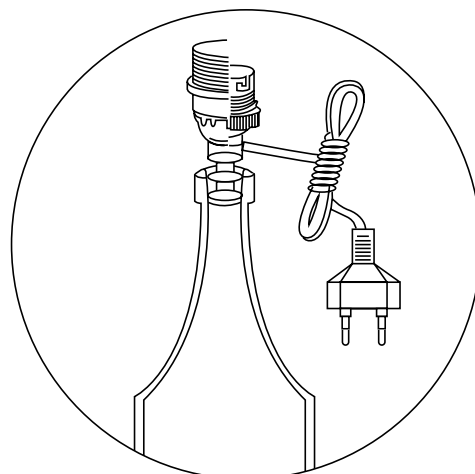

| Réf. | Matériau | Filetage |
|--------|--------------|-------------|
| 342020 | polyéthylène | mâle 10 x 1 |

DESSUS À ÉTAGES



Laiton toilé
Trou | Ø11mm
Épaisseur | 0.5mm

| Réf. | Ø mm |
|--------|------|
| 346425 | Ø25 |
| 346436 | Ø30 |
| 346447 | Ø35 |
| 346458 | Ø40 |
| 346469 | Ø45 |
| 346470 | Ø50 |

| Réf. | Ø mm |
|--------|------|
| 346481 | Ø55 |
| 346492 | Ø60 |
| 346513 | Ø65 |
| 346524 | Ø70 |
| 346546 | Ø80 |
| 346568 | Ø90 |

| Réf. | Ø mm |
|--------|------|
| 346580 | Ø100 |
| 346591 | Ø105 |
| 346602 | Ø110 |
| 346613 | Ø115 |
| 346635 | Ø125 |
| 346657 | Ø135 |

COMPOSANTS LUSTRIERIE

DESSUS GALBÉ



346914

| Réf. | Matériau | Trou mm | Ømm |
|--------|--------------|---------|-----|
| 346914 | laiton toilé | Ø11 | Ø70 |

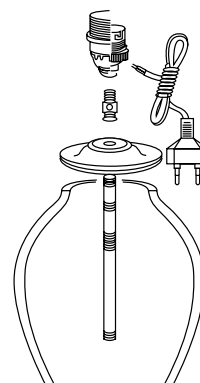

Exemple d'utilisation

SPOTISOL AVEC BAGUE



167438



Utilisable de -20°C à + 110°C en continu
 Maximum power | 50W with roll Puissance maximale | 50W avec isolant en rouleau / 35W avec isolant soufflé
 Résistance au feu autoextinguible UL 94 V2
 Hauteur | 105mm

PASSE-FILS



232763



232771

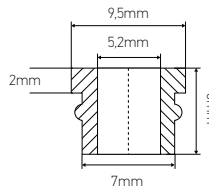

232803



232821



232837

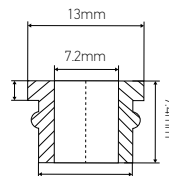

232911

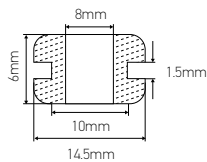

232901

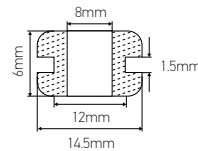

| Ref. | Matériau | Pour tube | Passage conducteurs |
|--------|--------------|-----------|---------------------|
| 232763 | polyéthylène | Ø8 | Ø5 |
| 232771 | polyéthylène | Ø8 | Ø5 |
| 232803 | polyéthylène | Ø10 | Ø7.2 |
| 232821 | polyéthylène | Ø10 | Ø7.2 |
| 232837 | polyéthylène | Ø10 | Ø7.2 |
| 232911 | PVC | Ø10 | Ø8 |
| 232901 | PVC | Ø12 | Ø6 |

SERRE-CÂBLE AVEC VIS D'ARRÊT



230461



230573



230591

| Réf. | Matériau | Extérieure Ø _{mm} | Intérieure Ø _{mm} |
|--------|----------|----------------------------|----------------------------|
| 230461 | nylon | Ø10.5 | Ø6.5 |
| 230573 | nylon | Ø12 | Ø7.4 |
| 230591 | nylon | Ø12 | Ø7.4 |

MAINTIENS DE CÂBLE

T 90°C



230133



230313

| Réf. | Matériau | Pour câble | Épaisseur mm |
|--------|----------|------------------|--------------|
| 230133 | nylon | H03VV-F, H05VV-F | 2 |
| 230313 | nylon | H03VV-F | 2 |

T 110°C



230349



| Réf. | Matériau | Pour câble | Épaisseur mm |
|--------|----------|------------|--------------|
| 230349 | nylon | H03VV-F | 2 |

SERRE-CÂBLES AVEC VIS DE BLOCAGE

T 110°C |  100/1000



230603



230611



230613



230619

| Ref. | Matériau | Thread | Ømm |
|--------|--------------|----------------|------|
| 230603 | nylon | femelle 10 x 1 | Ø7 |
| 230611 | nylon | femelle 10 x 1 | Ø7 |
| 230613 | nylon | femelle 10 x 1 | Ø6.5 |
| 230619 | polycarbonat | femelle 10 x 1 | - |

T 90°C |  100/1000



230723



230731

| Ref. | Matériau | Thread | Extérieure Ømm | Intérieure Ømm |
|--------|----------|---------------------|----------------|----------------|
| 230723 | nylon | raccord mâle 10 x 1 | Ø13 | Ø8.4 |
| 230731 | nylon | raccord mâle 10 x 1 | Ø13 | Ø8.4 |

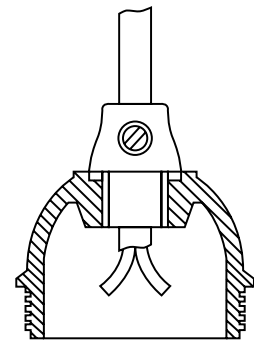

| T 100°C |



230991

| Ref. | Matériau | Thread |
|--------|----------|---------------------|
| 230991 | nylon | raccord mâle 10 x 1 |

SERRE-CÂBLE

T 85°C



231003



231011

| Ref. | Matériau | Thread |
|--------|----------|---------------------------------------|
| 231003 | nylon | raccord mâle pas international 10 x 1 |
| 231011 | nylon | raccord mâle pas international 10 x 1 |

T 115°C



231029

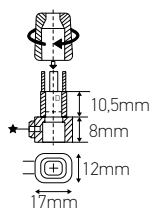

231129



231139

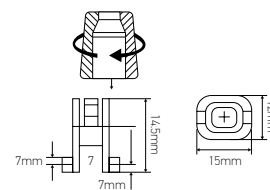

| Ref. | Matériau | Thread |
|--------|--------------|---|
| 231029 | polycarbonat | raccord femelle, longueur filetage 10.5mm |
| 231129 | polycarbonat | pour douille, double trou de culot femelle 10mm |
| 231139 | polycarbonat | Pour douille, culot trou lisse 10mm |



231159

| Ref. | Matériau | Thread | Ø x H _{mm} |
|--------|--------------|-------------------------|---------------------|
| 231159 | polycarbonat | capuchon femelle 10 x 1 | Ø14.8 x 18.5 |

ISOLATEUR POUR DOUILLE

T 100°C



231507



231494

| Ref. | Matériau | Pour douille | Pour câble |
|--------|----------|--------------|------------|
| 231507 | nylon | E27 | H03VVH-2F |
| 231494 | nylon | E14 | H03VVH-2F |

Tube, embout

TUBE DE ISOSTOP

T 85°C



231614



231627

| Ref. | Pour douille | Pour câble |
|--------|--------------|------------|
| 231614 | E14 | H03VVH-2F |
| 231627 | E27 | H03VVH-2F |

Avec arrêt de traction et de rotation
Polyacétal blanc
Pour douille E14 /E27

TUBE DE RACCORDEMENT



T 90°C



231637

Arrêt de traction et de rotation
Pour douille E14 raccord métal vis d'arrêt ou taraudé 10 x 1
Pour douille E27 culot taraudé 10 x 1 exclusivement

ARRÊTS DE TRACTION ET DE ROTATION

T 85°C



231747

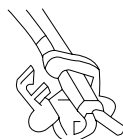

Introduire le câble dans la mâchoire de l'ISOLATOP

| Ref. | Matériau | Pour douille | Pour câble |
|--------|------------------|--------------|------------|
| 231747 | polyacétal blanc | E27 | H03VVH-2F |

Sortie latérale

ARRÊTS DE TRACTION ET DE ROTATION POUR DOUILLE E14

T 85°C

0.5A
250V



231734



Introduire le câble dans la mâchoire de l'ISOLATOP

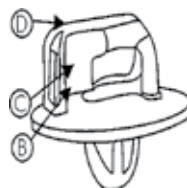

Afin d'obtenir un bon serrage, la languette B du crochet de verrouillage doit être en appui avec la partie C de la mâchoire supérieure

Isolatop, sortie latérale, polyacétal blanc, embout isolant, pour câble H03 VVH - 2F

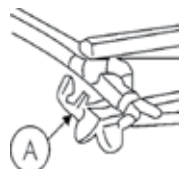

A l'aide d'une pince, resserrer les mâchoires sur le câble et à l'aide d'un doigt repousser le crochet a de verrouillage

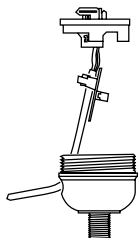

Arrêts de traction et de rotation pour douilles culot avec passage de câble Ø 5mm

ARRÊTS DE TRACTION

T 110°C



232953

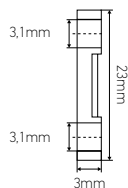
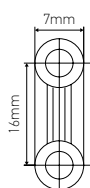

| Ref. | Matériau | Pour tube |
|--------|----------|-----------|
| 232953 | nylon | Ø3.1 |

ARRÊTS DE TRACTION

50 / 1000 | T 110°C



231856
Pour Douille E14



231869
Pour Douille E27

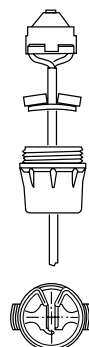

Arrêt de traction pour câble, Nylon noir, épaisseur 6mm, H03 VH - 2F

BAGUE FIXATION SPOT MR16 x 10



380507

| Ref. | Matériel | Épaisseur mm | Dim. mm | PCB Inner | PCB Outer |
|--------|----------|--------------|---------|-----------|-----------|
| 380507 | acier | 1.3 | Ø60 | - | - |

RACCORD POUR PIED DE LAMPE EN BOIS

100/1000



232561

| Ref. | Matériau | Thread | Ø mm |
|--------|-----------|--------------------|------|
| 232561 | polyamide | raccord mâle10 x 1 | Ø10 |

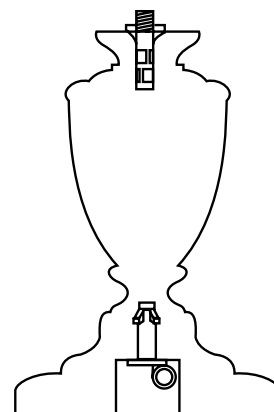

BOÎTIER BILAMPE

EN 60598

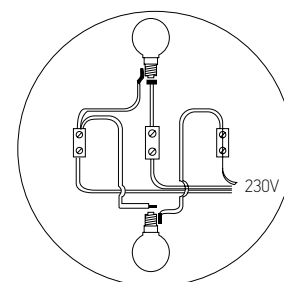
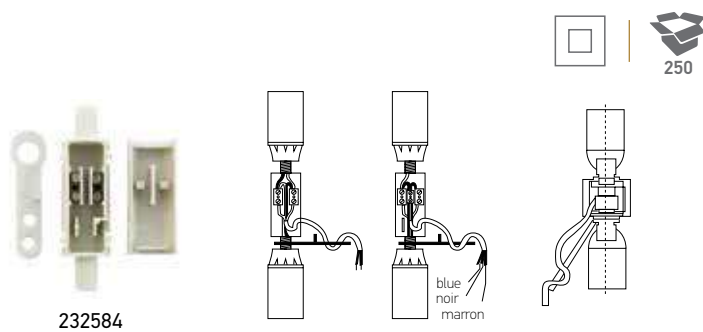

Fermeture par clipsage
Douille non comprise

| Ref. | Matériau | Thread | Pour douille | Pour câble |
|--------|-----------------|----------------------------|--------------|------------|
| 232584 | thermoplastique | double raccord mâle 10 x 1 | E14 / E27 | H03VVH-2F |

EMBOUT D'ISOLATION

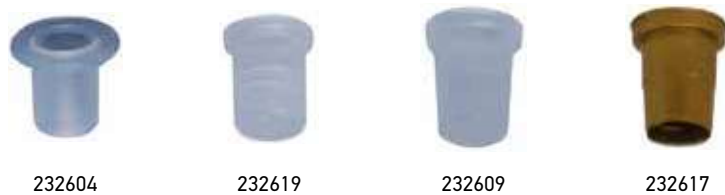

| Ref. | Pour tube | Passage conducteurs |
|--------|-----------|---------------------|
| 232604 | Ø7 | Ø5.5 |
| 232619 | Ø13 | Ø7.5 |
| 232609 | Ø10 | Ø5.9 |
| 232617 | Ø10 | Ø5.9 |



| Ref. | Matériau | Pour tube | Passage conducteurs |
|--------|--------------|-----------|---------------------|
| 232612 | polyéthylène | Ø11 | Ø6 |

CONNECTEUR

T 90°C | IP 20 | 100/1000

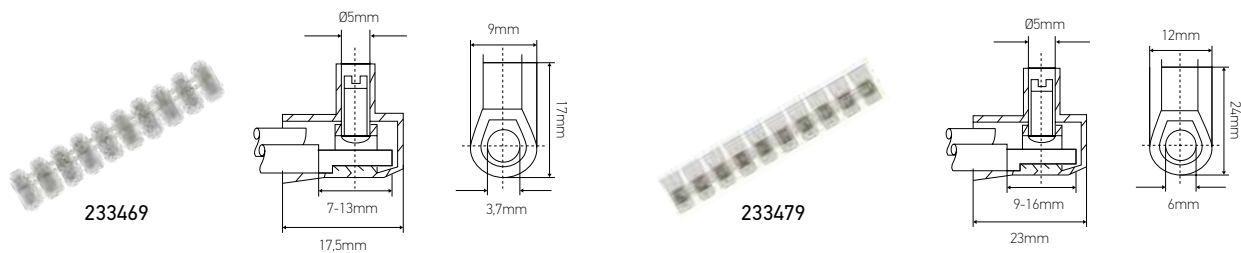

| Ref. | Matériau | Pôles | Section |
|--------|--------------|-------|---------------------------|
| 233469 | polycarbonat | 10 | 2.5mm ² - 380V |
| 233479 | polycarbonat | 10 | 6mm ² - 380V |

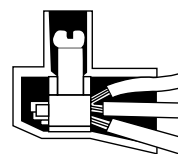

BORNE DE CONNEXION POUR CLASSE I

16A
380V | | 100/1000

EN 60598

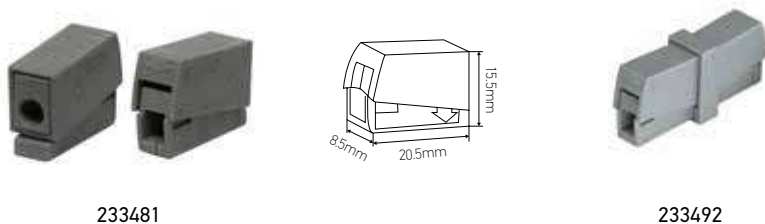

| Ref. | Dénudage du câble | Bornes de connexion |
|--------|-------------------|---------------------|
| 233481 | 9-11mm | Simple |
| 233492 | 9-11mm | double |

Temperature 105°C en continu, 170°C en pointe
Pour 0.5 - 2.5mm² câble

JEUX DE BORNIERES EMBROCHABLES À COLLERETTE DE CENTRAGE

16A
80V | T 100°C | 1/100

EN 60998



| Ref. | Pour fusible | Pôles |
|--------|--------------|-------|
| 233538 | 5 x 20mm | 2 |
| 233542 | 5 x 20mm | 3 |

Polyamide
Section conducteur et dénudage | 0.5 - 4mm² & 7mm²
160°C en pointe
Résistance au cheminement PTI600
Connecteur mâles et femelles avec languette de protection
Jusqu'à 2,5mm²



233519

| Ref. | Entrées | Fils | Couleur |
|--------|---------|------|---------|
| 233519 | 3 | 3 | Gris |

9-10mm
 3 x 0.08 – 4mm² "s" (2.5mm² "r" + "sr") 400 V/4kV IN 32 A



COMPOSANTS LUSTRIERIE

BOÎTIERS DE CONNEXION POUR CLASSE II

T 105°C | Glow wire 850° |  |  250

EN 60998



233709



233705

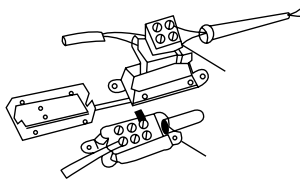

Bornier amovible
Avec manchon
Pour raccordement à l'installation
Longueur | 80mm
Fermeture par clipsage
Pour câble ovale / rond câble



233717

Bornier amovible
Sans manchon
Pour câble ovales
Isolant thermoplastique
Dispositifs d'arrêt de traction fermeture par clipsage

| Ref. | Matériau | Pour câble | L x W x H _{mm} |
|--------|-----------------|----------------|-------------------------|
| 233709 | thermoplastique | round H03VV-F | 42 x 19 x 11.5mm |
| 233705 | thermoplastique | oval H03VVH-2F | 42 x 19 x 11.5mm |
| 233717 | thermoplastique | oval | 46 x 19.5 x 11mm |

BORNE À LEVIER

T 85°C

EN 60998



233502



233503



233505

| Ref. | Pour câble | Pôles | L x W x H _{mm} |  |
|--------|-------------------------|-------|-------------------------|---|
| 233502 | 0.2 to 4mm ² | 2 | 13.1 x 8.3 x 18.6mm | 50 |
| 233503 | 0.2 to 4mm ² | 3 | 18.7 x 8.3 x 18.6mm | 50 |
| 233505 | 0.2 to 4mm ² | 5 | 29.9 x 8.3 x 18.6mm | 25 |

Avec leviers de commande

BOÎTIER DE CONNEXION

T 105°C

Glow
wire 850°



EN 60598



233731

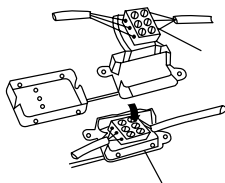

| Ref. | Material | For cable | L x W x H _{mm} |
|--------|---------------|---|-------------------------|
| 233731 | thermoplastic | 2 x 0.75mm ² + 3 x 0.75mm ² | 42.5 x 27.5 x 11.5 |

Thermoplastique
Pour câble
Avec serre-câble
Distribution par fixation centrale ou par 3 sorties latérales
à pinces
Fermeture par clipsage

DOMINOS 1 - 3 BORNES



260120

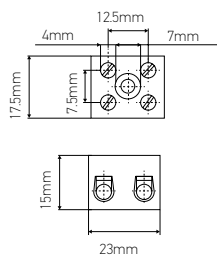

| Ref. | Plot |
|--------|------|
| 260120 | 2 |

Avec corps isolant steatine
Capacité de connection | 2,5mm² de câble de section



VERRERIES & ACCESSOIRES

| | |
|---|-----|
| VERRERIES..... | 213 |
| ACCESSOIRES POUR VERRERIES..... | 216 |
| ACCESSOIRES POUR LAMPES À PÉTROLE | 227 |



189627
Câble textile
rond coton

187554
Douille

28631
Standard LED 6W

187590
Verrerie

189204
Adaptateur griffe

VERRERIE POUR DOUILLES E27



187590



187591

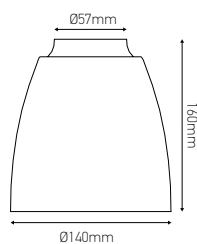

| Réf. | Matériau | Finition | Griffe mm |
|--------|----------|----------|-----------|
| 187590 | verre | claire | Ø57 |
| 187591 | verre | ambrée | Ø57 |

Compatible avec la griffe de suspension ref 289204

VERRERIE POUR LAMPES MAZDA



365063



365074



365085



365096

| Réf. | Col mm | Finition | Ø x Hmm |
|--------|--------|----------|------------|
| 365063 | Ø28 | opale | Ø160 x 140 |
| 365074 | Ø28 | opale | Ø205 x 190 |
| 365085 | Ø40 | opale | Ø205 x 190 |
| 365096 | Ø40 | opale | Ø260 x 220 |

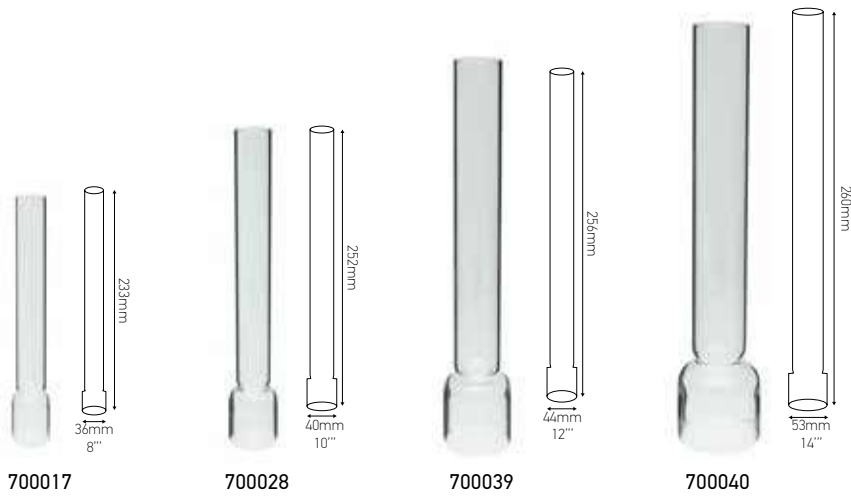

| Ref. | Finition | Kosmos | Ø x H _{mm} |
|--------|----------|--------|---------------------|
| 700017 | clair | 8" | Ø36 x 233 |
| 700028 | clair | 10" | Ø40 x 252 |
| 700039 | clair | 12" | Ø44 x 256 |
| 700040 | clair | 14" | Ø53 x 260 |



| Réf. | Finition | Matador | Ø x H _{mm} |
|--------|----------|---------|---------------------|
| 700062 | clair | 15" | Ø53 x 268 |
| 700084 | clair | 20" | Ø63 x 280 |
| 700095 | satiné | 20" | Ø63 x 280 |

VERRERIE POUR LAMPES À PÉTROLE

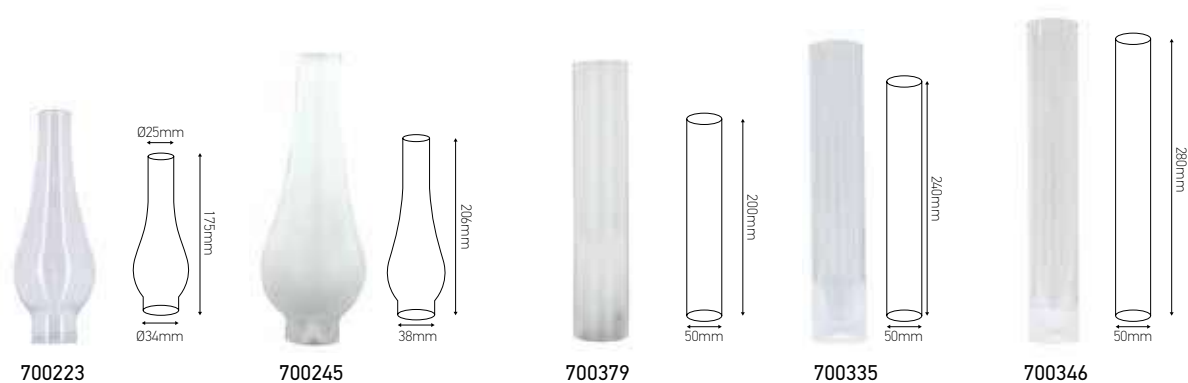

| Réf. | Finition | Forme | Ø x H _{mm} |
|---------------|----------|---------------------|---------------------|
| 700223 | clair | bombés « Viennois » | Ø34 x 175 |
| 700245 | satiné | bombés « viennois » | Ø38 x 206 |
| 700379 | satiné | verre cylindrique | Ø50 x 200 |
| 700335 | clair | verre cylindrique | Ø50 x 240 |
| 700346 | clair | verre cylindrique | Ø50 x 280 |

VERRERIE POUR LAMPES À PÉTROLE



| Réf. | Finition | Forme | Ø x H _{mm} |
|---------------|----------|--------|---------------------|
| 700101 | clair | pigeon | Ø33 x 92mm |

RACCORD HUBLLOT



289658

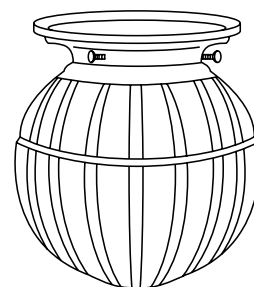

| Réf. | Matériau | Filetage | Dim. Ø x H _{mm} |
|--------|---------------|----------------|--------------------------|
| 289658 | laiton chromé | femelle 10 x 1 | Ø85 x 27mm |

GRIFFE 57mm



288525



288636

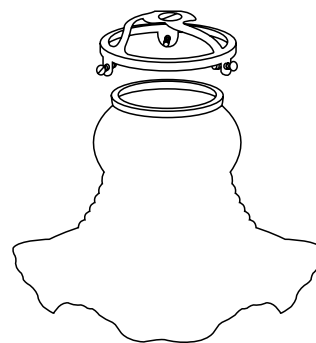

| Réf. | Matériau | Trou Ø _{mm} | Hauteur mm |
|--------|----------|----------------------|------------|
| 288525 | laiton | 11 | 23 |
| 288636 | laiton | 28 | 24.3 |

ADAPTATEUR GRIFFE POUR DOUILLE



288760



288869

| Réf. | Matériau | Trou Ø _{mm} | Dim. Ø x H _{mm} |  |
|--------|-------------------|----------------------|--------------------------|---|
| 288760 | laiton poli verni | 11 | 85 x 29 | 5 |
| 288869 | laiton poli verni | 11 | 100 x 29 | 5 |

ADAPTATEUR GRIFFE POUR DOUILLE



289204

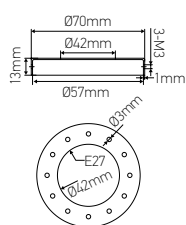

289205

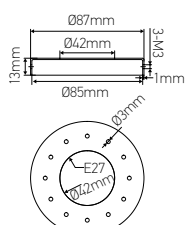

289206

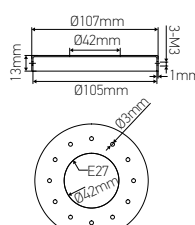

| Réf. | Matériau | Trou Ø _{mm} | Dim. Ø x H _{mm} |  |
|---------------|----------|----------------------|--------------------------|---|
| 289204 | acier | 42 | 70 x 13 | 10 |
| 289205 | acier | 42 | 87 x 13 | 10 |
| 289206 | acier | 42 | 107 x 13 | 10 |

Matériau | Acier

RESSORT CORDE DE PIANO



290615

| Réf. | Matériau | Trou Ø _{mm} | Longueur mm |
|---------------|----------|----------------------|-------------|
| 290615 | acier | 10.5 | 90 |



703012

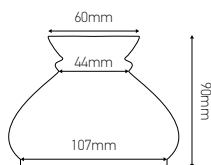

703023

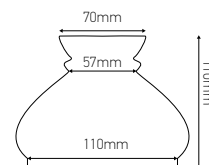

703034

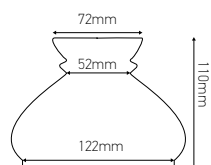

703045

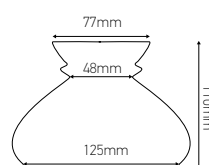

703059

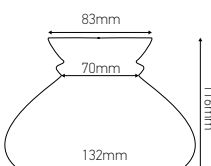

703060

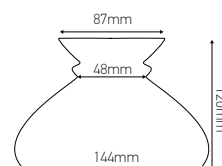

703072

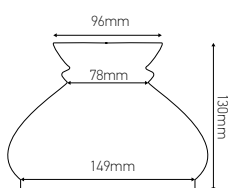

| Réf. | Matériau | Finition | Ø x H _{mm} |
|--------|----------|----------|---------------------|
| 703012 | verre | opale | Ø107 x 90 |
| 703023 | verre | opale | Ø110 x 110 |
| 703034 | verre | opale | Ø122 x 110 |
| 703045 | verre | opale | Ø125 x 110 |
| 703059 | verre | opale | Ø132 x 116 |
| 703060 | verre | opale | Ø144 x 120 |
| 703072 | verre | opale | Ø149 x 130 |



703096

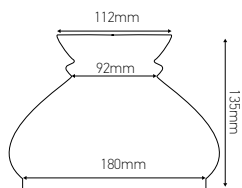

703107

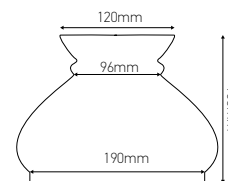

703120

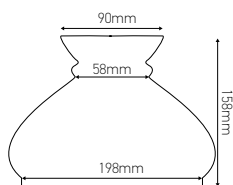

703186

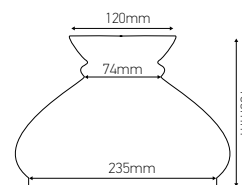

703325

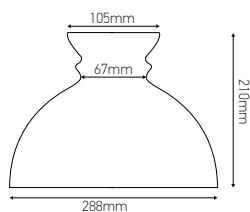

703336

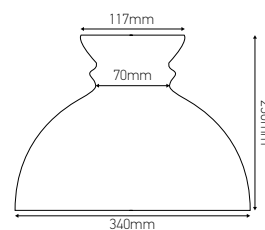

VERRERIES

| Réf. | Matériau | Finition | Ø x H _{mm} |
|--------|----------|----------|---------------------|
| 703096 | verre | opale | Ø180 x 135 |
| 703107 | verre | opale | Ø190 x 165 |
| 703120 | verre | opale | Ø198 x 158 |
| 703186 | verre | opale | Ø235 x 185 |
| 703325 | verre | opale | Ø288 x 210 |
| 703336 | verre | opale | Ø340 x 230 |

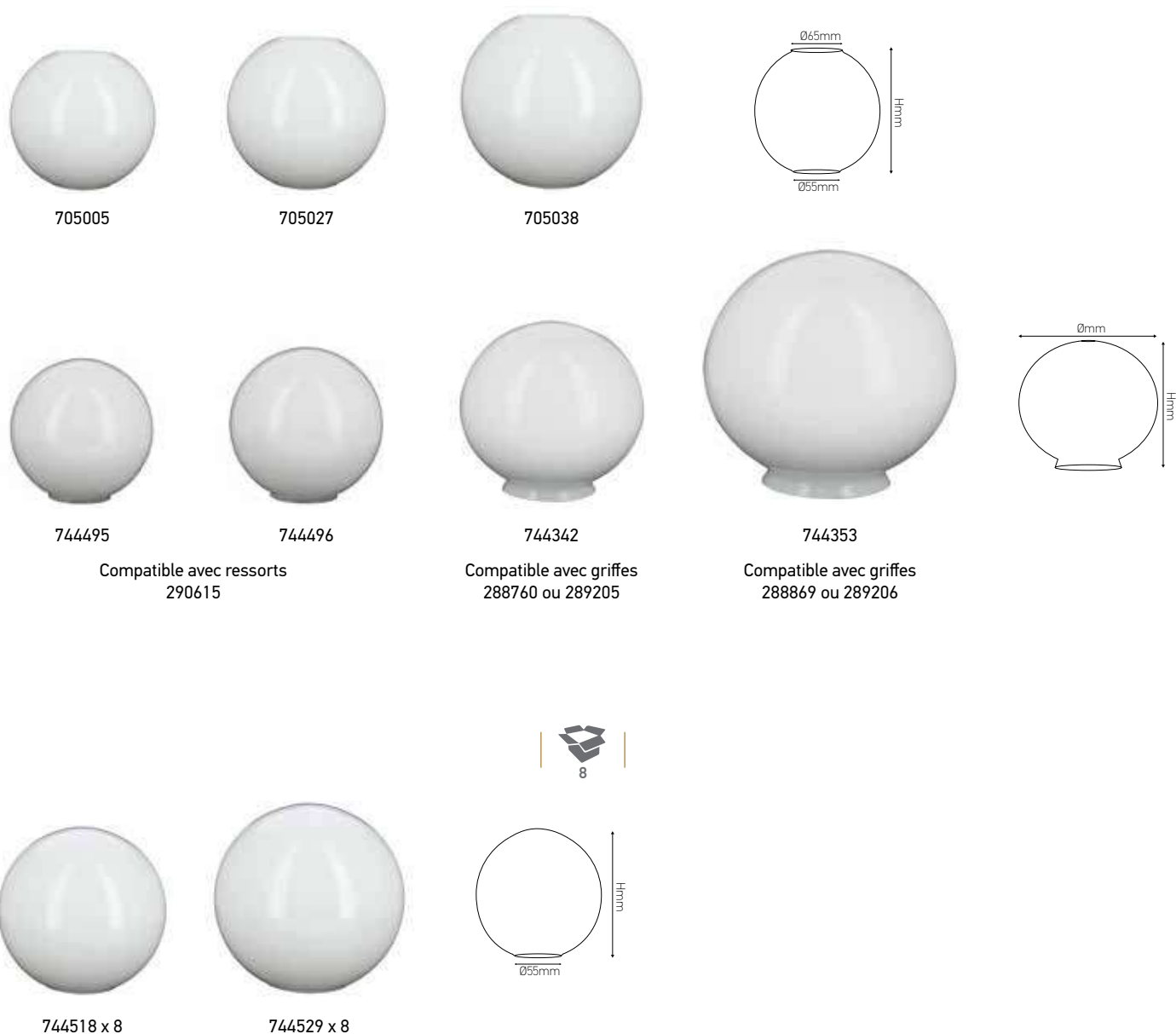

| Réf. | Matériau | Finition | Col mm | Ouverture haut mm | Ouverture bas mm | Ø x Hmm |
|---------------|----------|----------|--------|-------------------|------------------|--------------|
| 705005 | verre | opale | - | Ø65 | Ø55 | Ø130 x 115mm |
| 705027 | verre | opale | - | Ø65 | Ø55 | Ø150 x 137mm |
| 705038 | verre | opale | - | Ø65 | Ø55 | Ø180 x 160mm |
| 744495 | verre | opale | Ø50 | - | Ø50 | Ø100 x 100mm |
| 744496 | verre | opale | Ø50 | - | Ø50 | Ø120 x 120mm |
| 744342 | verre | opale | Ø85 | - | - | Ø80 x 150mm |
| 744353 | verre | opale | Ø100 | - | - | Ø200 x 200mm |
| 744518 | verre | mat | Ø40 | - | - | Ø130 x 126mm |
| 744529 | verre | mat | Ø40 | - | - | Ø150 x 150mm |

VERRERIE TULIPE «ÉPI» STYLE VINTAGE



712069



715168

| Réf. | Matériau | Finition | Ø x H _{mm} |
|---------------|----------|----------------------|---------------------|
| 712069 | verre | dépoli - bord clair | Ø145 x 110 |
| 715168 | verre | dépoli - borde pêche | Ø145 x 110 |

Griffes | 288525, 288636, 289204

TULIPE POUR LUSTRES



744603



744624

| Réf. | Matériau | Finition | Col mm | Ø x H _{mm} |
|---------------|----------|----------|--------|---------------------|
| 744603 | verre | satinée | Ø28 | Ø103 x 80 |
| 744624 | verre | satinée | Ø28 | Ø135 x 100 |

Tulipe bouton - 5 pétales - Verre satiné

ABAT-JOURS OPALES



730367



730502

| Réf. | Matériau | Finition | Ø x H _{mm} |
|---------------|----------|----------|---------------------|
| 730367 | verre | opale | Ø250 x 55 |
| 730502 | verre | opale | Ø230 x 112 |

Griffes | 288525, 288636, 289204

GLOBE SATINÉS GRAVURE STYLE «LOUIS XV»



705263



705274



705285



705296

| Réf. | Matériau | Finition | Ouverture haut mm | Ouverture bas mm | Ø x H _{mm} |
|--------|----------|--------------|-------------------|------------------|---------------------|
| 705263 | verre | opale satiné | Ø65 | Ø50 | Ø130 x 115 |
| 705274 | verre | opale satiné | Ø65 | Ø50 | Ø150 x 137 |
| 705285 | verre | opale satiné | Ø65 | Ø50 | Ø180 x 160 |
| 705296 | verre | opale satiné | Ø65 | Ø55 | Ø200 x 195mm |

TULIPE SATINÉE GRAVÉE



706426



| Réf. | Matériau | Finition | Col _{mm} | Ø x H _{mm} |
|--------|----------|--------------|-------------------|---------------------|
| 706426 | verre | opale satiné | Ø28 | Ø90 x 115mm |

VERRERIE TULIPE



710612



| Réf. | Matériau | Finition | Col _{mm} | Ø x H _{mm} |
|--------|----------|--------------|-------------------|---------------------|
| 710612 | verre | opale satiné | Ø28 | Ø90 x 115 |



VERRERIE FLAMME STYLE «EMPIRE»



713475

713488

713517

| Réf. | Matériau | Finition | Griffe | Griffe mm | Ø x H _{mm} |
|---------------|----------|-------------|--------------------------|-----------|---------------------|
| 713475 | verre | opal satiné | 288525 / 288636 | 57 | Ø90 x 125 |
| 713488 | verre | opal satiné | 288760 / 289658 / 289205 | 80 | Ø110 x 165 |
| 713517 | verre | opal satiné | 288869 / 289206 | 100 | Ø170 x 220 |

VERRERIE TULIPE STYLE «ART DÉCO»



714696

714663

| Réf. | Matériau | Finition | Griffe | Support | Ø x H _{mm} |
|---------------|----------|-------------|-----------------|--------------|---------------------|
| 714696 | verre | transparent | - | E14 B22 | Ø98 x 129 |
| 714663 | verre | transparent | 288525 / 288636 | Griffe Ø57mm | Ø107 x 136 |



TULIPE POUR LUSTRES



745367



745480



745478



745490

| Réf. | Finition | Col mm | Ø x Hmm |
|---------------|--|--------|------------|
| 745367 | lustré ambre verre | 48 | Ø117 x 130 |
| 745480 | satinée ambre, gravure claire | 50 | Ø140 x 115 |
| 745478 | satinée, gravure claire | 50 | Ø130 x 135 |
| 745490 | satinée gravée, bord ambré côtes torsadées | 55 | Ø117 x 130 |

GLOBE SATINÉS GRAVÉS POUR LUSTRES



745498



745500



745501

| Réf. | Finition | Col mm | Ø x Hmm |
|---------------|-------------------------------|--------|------------|
| 745498 | satinée, gravure claire | 50 | Ø120 x 120 |
| 745500 | satinée, gravure claire | 50 | Ø137 x 140 |
| 745501 | lustrée ambre, gravure claire | 50 | Ø120 x 130 |

CYLINDRE VERRE TRANSPARENT POUR DOUILLE E14



710507

| Réf. | Matériau | Finition | Col mm | Douille | Ø x Hmm |
|---------------|----------|-------------|--------|---------|------------|
| 710507 | verre | transparent | 42 | E27 | Ø110 x 250 |

Suspension en verre pour douille avec bagues et montures

ACCESSOIRE POUR LAMPES À PÉTROLE



700448



700761



700783

| Réf. | Matériau | Description | L x W _{mm} |
|---------------|-------------|----------------------|---------------------|
| 700448 | laiton poli | bec méché kosmos 14" | - |
| 700761 | - | mèche frangée 14" | 200 x 64 |
| 700783 | - | mèche pigeon | 140 x 5 |

BEC POUR LAMPE PÉTROLE ÉLECTRIQUE



360301

| Réf. | Matériau | Ø x H _{mm} |
|---------------|-------------|---------------------|
| 360301 | laiton poli | Ø45 x 49 |

Galerie avec embase, clé soudée et piedouche pour douille E14 - calibre 14"



FOURREAUX & BOUGIES



| | |
|---|-----|
| FOURREAUX SANS GOUTTES | 230 |
| FOURREAUX AVEC GOUTTES | 231 |
| SUPPORTS BOUGIE E14 | 232 |
| BOUGIE «GRAND SIÈCLE» LES MODERNE | 235 |
| BOUGIE «VIVAFLAMME» E14..... | 236 |

FOURREAU SANS GOUTTES

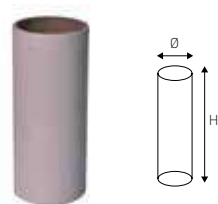

| Réf. | Matériau | Couleur | Pour douille fourreau | Ø x H _{mm} |
|--------|---------------|---------------|-----------------------|---------------------|
| 200106 | carton rigide | blanc antique | E14 - Ø22,5mm | Ø24 x 65 |
| 200107 | carton rigide | blanc antique | E14 - Ø22,5mm | Ø24 x 70 |
| 200108 | carton rigide | blanc antique | E14 - Ø22,5mm | Ø24 x 80 |
| 200109 | carton rigide | blanc antique | E14 - Ø22,5mm | Ø24 x 85 |
| 200110 | carton rigide | blanc antique | E14 - Ø22,5mm | Ø24 x 100 |
| 200112 | carton rigide | blanc antique | E14 - Ø22,5mm | Ø24 x 120 |
| 200118 | carton rigide | blanc antique | E14 - Ø22,5mm | Ø24 x 170 |
| 200121 | carton rigide | blanc antique | E14 - Ø22,5mm | Ø24 x 230 |

2A
250V

T 135° C

650°



EN 60238

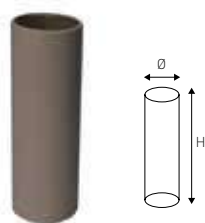

202041

| Réf. | Matériau | Couleur | Pour douille fourreau | Ø x H _{mm} |
|--------|---------------|---------------|-----------------------|---------------------|
| 202041 | carton rigide | blanc antique | E14 - Ø22,5mm | Ø27 x 70 |

FOURREAU AVEC GOUTTES

650°  10



| Réf. | Matériau | Couleur | Pour douille fourreau | Ø x H _{mm} |
|--------|---------------|---------------|-----------------------|---------------------|
| 200143 | carton rigide | blanc antique | E14 - Ø22,5mm | Ø24 x 65 |
| 200145 | carton rigide | blanc antique | E14 - Ø22,5mm | Ø24 x 70 |
| 200148 | carton rigide | blanc antique | E14 - Ø22,5mm | Ø24 x 80 |
| 200151 | carton rigide | blanc antique | E14 - Ø22,5mm | Ø24 x 85 |
| 200153 | carton rigide | blanc antique | E14 - Ø22,5mm | Ø24 x 100 |
| 200216 | carton rigide | ivoire patiné | E14 - Ø22,5mm | Ø24 x 65 |
| 200237 | carton rigide | ivoire patiné | E14 - Ø22,5mm | Ø24 x 70 |
| 200248 | carton rigide | ivoire patiné | E14 - Ø22,5mm | Ø24 x 80 |
| 200249 | carton rigide | ivoire patiné | E14 - Ø22,5mm | Ø24 x 85 |
| 200250 | carton rigide | ivoire patiné | E14 - Ø22,5mm | Ø24 x 100 |
| 200345 | carton rigide | carton patiné | E14 - Ø22,5mm | Ø24 x 65 |
| 200347 | carton rigide | carton patiné | E14 - Ø22,5mm | Ø24 x 70 |
| 200348 | carton rigide | carton patiné | E14 - Ø22,5mm | Ø24 x 80 |
| 200349 | carton rigide | carton patiné | E14 - Ø22,5mm | Ø24 x 85 |
| 200350 | carton rigide | carton patiné | E14 - Ø22,5mm | Ø24 x 100 |

Carton recouvert de cire

FOURREUX & BOUGIES

2A 250V | T 135° C | 650°  10



| Réf. | Matériau | Couleur | Pour douille fourreau | Ø x H _{mm} |
|--------|---------------|---------------|-----------------------|---------------------|
| 202017 | carton rigide | carton patiné | E14 - Ø26mm | Ø27 x 70 |
| 202019 | carton rigide | carton patiné | E14 - Ø26mm | Ø27 x 85 |
| 202052 | carton rigide | blanc antique | E14 - Ø26mm | Ø27 x 70 |
| 202074 | carton rigide | blanc antique | E14 - Ø26mm | Ø27 x 100 |
| 202246 | carton rigide | ivoire patiné | E14 - Ø26mm | Ø27 x 70 |
| 202259 | carton rigide | ivoire patiné | E14 - Ø26mm | Ø27 x 85 |

SUPPORT BOUGIE E14 POUR FEMELLE 10 x 1

2A
250V

T 135° C

650°



201047

201059

201062

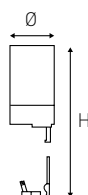

| Réf. | Matériau | Filletée | Ø x H _{mm} |
|---------------|-----------------|----------------|---------------------|
| 201047 | thermoplastique | femelle 10 x 1 | Ø23 x 65 |
| 201059 | thermoplastique | femelle 10 x 1 | Ø23 x 80 |
| 201062 | thermoplastique | femelle 10 x 1 | Ø23,5 x 100 |

Raccord métal 10 x 1, vis d'arrêt

SUPPORT BOUGIE E14 FEMELLE BECS

2A
250V

T 135° C

650°



201072

201084

201096

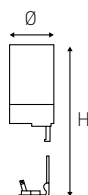

| Réf. | Matériau | Filletée | Ø x H _{mm} |
|---------------|---------------------------|----------------------|---------------------|
| 201072 | isolant thermodurcissable | raccord métal 10 x 1 | Ø23,5 x 65 |
| 201084 | isolant thermodurcissable | raccord métal 10 x 1 | Ø23,5 x 85 |
| 201096 | isolant thermodurcissable | raccord métal 10 x 1 | Ø23,5 x 100 |







205727



205743

| Réf. | Couleur | Pour douille fourreau | Ø x H _{mm} |
|---------------|---------------|-----------------------|---------------------|
| 205727 | ivoire satiné | E14 | Ø22 x 170 |
| 205743 | ivoire satiné | E14 | Ø22 x 230 |

Modèle déposé
Bougie cylindriques sans talon
non câblé



206850



206877



206893

| Réf. | Couleur | Pour douille fourreau | Ø x H _{mm} |
|---------------|---------------|-----------------------|---------------------|
| 206850 | ivoire satiné | E10 | Ø22 x 110 |
| 206877 | ivoire satiné | E10 | Ø22 x 170 |
| 206893 | ivoire satiné | E10 | Ø22 x 230 |

Modèle déposé
Bougie conique
non câblé
Modèle déposé
Livrées non assemblées. Bornier de connexion intégré dans
la double coque
Raccordement direct du câble double isolation du luminaire
sur ce bornier

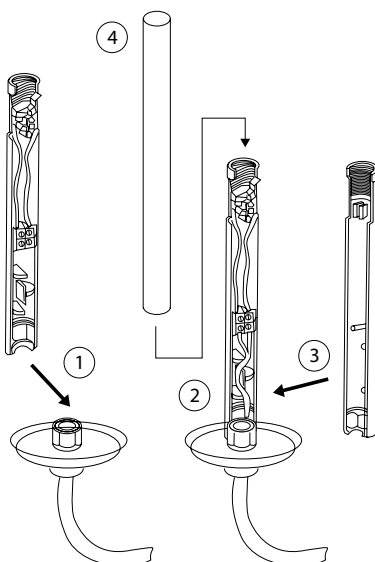

BOUGIE ELECTRONIQUE «VIVAFLAMME» E14



0.3W
Max.



Ra
≥85



204633

Lampe 3W avec contrepoids plastique
Compatible avec la référence 204637
Voltage | 230V AC +/- 10%
Compatible uniquement avec les références ci-dessous
Dimension | Ø19.5 x 102mm



204637

Compatible avec la lampe 3W référence 204633
Couleur de la lumière | LED blanc super chaud 2000K.
Ne peut pas être utilisé avec un variateur
Mouvement périodique de la source lumineuse toutes les - 30 à 40 secondes
La source lumineuse est remplaçable
Voltage | 230V AC +/- 10%
Dimension | Ø23.4 x 200mm



204633

+



204637

+



204638
23,4 x 200mm

⇒



204639



Récapitulatif des références

| Ref. | CATALOGUE | PAGE | EAN |
|-------|-------------|------|---------------|
| 11520 | SOURCES | 150 | 3125460115204 |
| 11530 | SOURCES | 150 | 3125460115303 |
| 13200 | SOURCES | 154 | 3125460132003 |
| 13230 | SOURCES | 154 | 3125460132300 |
| 14110 | SOURCES | 154 | 3125460141104 |
| 14400 | SOURCES | 153 | 3125460144006 |
| 14510 | SOURCES | 153 | 3125460145102 |
| 14621 | SOURCES | 141 | 3125460146215 |
| 15646 | SOURCES | 62 | 3125460156467 |
| 15647 | SOURCES | 62 | 3125460156474 |
| 15648 | SOURCES | 62 | 3125460156481 |
| 15649 | SOURCES | 63 | 3125460156498 |
| 15651 | SOURCES | 62 | 3125460156511 |
| 15652 | SOURCES | 62 | 3125460156528 |
| 15653 | SOURCES | 62 | 3125460156535 |
| 15654 | SOURCES | 63 | 3125460156542 |
| 15655 | SOURCES | 62 | 3125460156559 |
| 15656 | SOURCES | 62 | 3125460156566 |
| 15658 | SOURCES | 63 | 3125460156580 |
| 15900 | SOURCES | 152 | 3125460159000 |
| 16001 | SOURCES | 57 | 3125460160013 |
| 16003 | SOURCES | 57 | 3125460160037 |
| 16005 | SOURCES | 57 | 3125460160051 |
| 16007 | SOURCES | 57 | 3125460160075 |
| 16011 | SOURCES | 57 | 3125460160112 |
| 16015 | SOURCES | 57 | 3125460160150 |
| 16017 | SOURCES | 57 | 3125460160174 |
| 16021 | SOURCES | 61 | 3125460160211 |
| 16022 | SOURCES | 61 | 3125460160228 |
| 16023 | SOURCES | 61 | 3125460160235 |
| 16024 | SOURCES | 61 | 3125460160242 |
| 16026 | SOURCES | 61 | 3125460160266 |
| 16027 | SOURCES | 61 | 3125460160273 |
| 18455 | SOURCES | 41 | 3125460184552 |
| 18461 | SOURCES | 41 | 3125460184613 |
| 18462 | SOURCES | 40 | 3125460184620 |
| 18464 | SOURCES | 141 | 3125460184644 |
| 18467 | SOURCES | 39 | 3125460184675 |
| 18471 | ACCESSOIRES | 32 | 3125460184712 |
| 18473 | SOURCES | 141 | 3125460184736 |
| 18474 | SOURCES | 39 | 3125460184743 |
| 18476 | SOURCES | 39 | 3125460184767 |
| 18477 | SOURCES | 141 | 3125460184774 |
| 21000 | LUMINAIRES | 76 | 3125460210008 |
| 21001 | LUMINAIRES | 76 | 3125460210015 |
| 21002 | LUMINAIRES | 76 | 3125460210022 |
| 21003 | LUMINAIRES | 76 | 3125460210039 |
| 21004 | LUMINAIRES | 76 | 3125460210046 |
| 24976 | SOURCES | 116 | 3125460249763 |

New

New

| Ref. | CATALOGUE | PAGE | EAN |
|-------|------------|------|---------------|
| 24977 | SOURCES | 116 | 3125460249770 |
| 24978 | SOURCES | 116 | 3125460249787 |
| 24980 | SOURCES | 117 | 3125460249800 |
| 24990 | SOURCES | 115 | 3125460249909 |
| 24992 | SOURCES | 115 | 3125460249923 |
| 24993 | SOURCES | 114 | 3125460249930 |
| 24994 | SOURCES | 115 | 3125460249947 |
| 24996 | SOURCES | 115 | 3125460249961 |
| 24998 | SOURCES | 114 | 3125460249985 |
| 28623 | SOURCES | 96 | 3125460286232 |
| 28625 | SOURCES | 96 | 3125460286256 |
| 28626 | SOURCES | 96 | 3125460286263 |
| 28627 | SOURCES | 96 | 3125460286270 |
| 28631 | SOURCES | 96 | 3125460286317 |
| 28633 | SOURCES | 96 | 3125460286331 |
| 28639 | SOURCES | 96 | 3125460286393 |
| 28646 | SOURCES | 90 | 3125460286461 |
| 28647 | SOURCES | 90 | 3125460286478 |
| 28648 | SOURCES | 90 | 3125460286485 |
| 28649 | SOURCES | 90 | 3125460286492 |
| 28652 | SOURCES | 96 | 3125460286522 |
| 28653 | SOURCES | 96 | 3125460286539 |
| 28656 | SOURCES | 96 | 3125460286560 |
| 28658 | SOURCES | 90 | 3125460286584 |
| 28659 | SOURCES | 90 | 3125460286591 |
| 28660 | SOURCES | 96 | 3125460286607 |
| 28662 | SOURCES | 96 | 3125460286621 |
| 28664 | SOURCES | 96 | 3125460286645 |
| 28665 | SOURCES | 90 | 3125460286652 |
| 28666 | SOURCES | 90 | 3125460286669 |
| 28670 | SOURCES | 90 | 3125460286706 |
| 28671 | SOURCES | 90 | 3125460286713 |
| 28672 | SOURCES | 90 | 3125460286720 |
| 28673 | SOURCES | 90 | 3125460286737 |
| 28674 | SOURCES | 96 | 3125460286744 |
| 28675 | SOURCES | 96 | 3125460286751 |
| 28676 | SOURCES | 96 | 3125460286768 |
| 28677 | SOURCES | 96 | 3125460286775 |
| 28681 | SOURCES | 90 | 3125460286812 |
| 30100 | LUMINAIRES | 131 | 3125460301003 |
| 30101 | LUMINAIRES | 131 | 3125460301010 |
| 30102 | LUMINAIRES | 131 | 3125460301027 |
| 30103 | LUMINAIRES | 131 | 3125460301034 |
| 30104 | LUMINAIRES | 131 | 3125460301041 |
| 30105 | LUMINAIRES | 131 | 3125460301058 |
| 30106 | LUMINAIRES | 131 | 3125460301065 |
| 30107 | LUMINAIRES | 131 | 3125460301072 |
| 30108 | LUMINAIRES | 132 | 3125460301089 |
| 30109 | LUMINAIRES | 132 | 3125460301096 |

| Ref. | CATALOGUE | PAGE | EAN |
|-------|------------|------|---------------|
| 30110 | LUMINAIRES | 132 | 3125460301102 |
| 30111 | LUMINAIRES | 132 | 3125460301119 |
| 30112 | LUMINAIRES | 132 | 3125460301126 |
| 30113 | LUMINAIRES | 132 | 3125460301133 |
| 30114 | LUMINAIRES | 132 | 3125460301140 |
| 30115 | LUMINAIRES | 132 | 3125460301157 |
| 30116 | LUMINAIRES | 131 | 3125460301164 |
| 30117 | LUMINAIRES | 131 | 3125460301171 |
| 30118 | LUMINAIRES | 131 | 3125460301188 |
| 30119 | LUMINAIRES | 131 | 3125460301195 |
| 30120 | LUMINAIRES | 131 | 3125460301201 |
| 30121 | LUMINAIRES | 131 | 3125460301218 |
| 30122 | LUMINAIRES | 132 | 3125460301225 |
| 30123 | LUMINAIRES | 132 | 3125460301232 |
| 30124 | LUMINAIRES | 132 | 3125460301249 |
| 30125 | LUMINAIRES | 132 | 3125460301256 |
| 30126 | LUMINAIRES | 132 | 3125460301263 |
| 30127 | LUMINAIRES | 132 | 3125460301270 |
| 30128 | LUMINAIRES | 133 | 3125460301287 |
| 30129 | LUMINAIRES | 133 | 3125460301294 |
| 30130 | LUMINAIRES | 133 | 3125460301300 |
| 30131 | LUMINAIRES | 133 | 3125460301317 |
| 30132 | LUMINAIRES | 133 | 3125460301324 |
| 30133 | LUMINAIRES | 133 | 3125460301331 |
| 30134 | LUMINAIRES | 133 | 3125460301348 |
| 30135 | LUMINAIRES | 133 | 3125460301355 |
| 30136 | LUMINAIRES | 133 | 3125460301362 |
| 30137 | LUMINAIRES | 133 | 3125460301379 |
| 30138 | LUMINAIRES | 133 | 3125460301386 |
| 30139 | LUMINAIRES | 133 | 3125460301393 |
| 30140 | LUMINAIRES | 133 | 3125460301409 |
| 30141 | LUMINAIRES | 133 | 3125460301416 |
| 30142 | LUMINAIRES | 133 | 3125460301423 |
| 30143 | LUMINAIRES | 133 | 3125460301430 |
| 30144 | LUMINAIRES | 133 | 3125460301447 |
| 30145 | LUMINAIRES | 133 | 3125460301454 |
| 30146 | LUMINAIRES | 133 | 3125460301461 |
| 30147 | LUMINAIRES | 133 | 3125460301478 |
| 30148 | LUMINAIRES | 133 | 3125460301485 |
| 30149 | LUMINAIRES | 133 | 3125460301492 |
| 30150 | LUMINAIRES | 133 | 3125460301508 |
| 30151 | LUMINAIRES | 133 | 3125460301515 |
| 30152 | LUMINAIRES | 133 | 3125460301522 |
| 30160 | LUMINAIRES | 134 | 3125460301607 |
| 30161 | LUMINAIRES | 134 | 3125460301614 |
| 30162 | LUMINAIRES | 134 | 3125460301621 |
| 30163 | LUMINAIRES | 134 | 3125460301638 |
| 30164 | LUMINAIRES | 134 | 3125460301645 |
| 30165 | LUMINAIRES | 134 | 3125460301652 |

| Ref. | CATALOGUE | PAGE | EAN |
|--------|-------------|------|---------------|
| 30166 | LUMINAIRES | 134 | 3125460301669 |
| 30167 | LUMINAIRES | 134 | 3125460301676 |
| 30168 | LUMINAIRES | 134 | 3125460301683 |
| 30169 | LUMINAIRES | 134 | 3125460301690 |
| 30170 | LUMINAIRES | 134 | 3125460301706 |
| 30171 | LUMINAIRES | 134 | 3125460301713 |
| 30172 | LUMINAIRES | 135 | 3125460301720 |
| 30173 | LUMINAIRES | 135 | 3125460301737 |
| 30174 | LUMINAIRES | 135 | 3125460301744 |
| 30175 | LUMINAIRES | 135 | 3125460301751 |
| 30176 | LUMINAIRES | 135 | 3125460301768 |
| 30177 | LUMINAIRES | 135 | 3125460301775 |
| 30178 | LUMINAIRES | 135 | 3125460301782 |
| 30179 | LUMINAIRES | 135 | 3125460301799 |
| 30180 | LUMINAIRES | 118 | 3125460301805 |
| 30181 | LUMINAIRES | 118 | 3125460301812 |
| 30182 | LUMINAIRES | 118 | 3125460301829 |
| 30183 | LUMINAIRES | 118 | 3125460301836 |
| 30200 | LUMINAIRES | 136 | 3125460302000 |
| 30201 | LUMINAIRES | 136 | 3125460302017 |
| 30202 | LUMINAIRES | 136 | 3125460302024 |
| 30203 | LUMINAIRES | 136 | 3125460302031 |
| 30204 | LUMINAIRES | 136 | 3125460302048 |
| 30205 | LUMINAIRES | 136 | 3125460302055 |
| 30206 | LUMINAIRES | 136 | 3125460302062 |
| 30207 | LUMINAIRES | 136 | 3125460302079 |
| 30208 | LUMINAIRES | 137 | 3125460302086 |
| 30209 | LUMINAIRES | 137 | 3125460302093 |
| 30210 | LUMINAIRES | 137 | 3125460302109 |
| 30211 | LUMINAIRES | 137 | 3125460302116 |
| 30212 | LUMINAIRES | 137 | 3125460302123 |
| 30213 | LUMINAIRES | 137 | 3125460302130 |
| 30214 | LUMINAIRES | 137 | 3125460302147 |
| 30215 | LUMINAIRES | 137 | 3125460302154 |
| 30216 | LUMINAIRES | 137 | 3125460302161 |
| 30217 | LUMINAIRES | 137 | 3125460302178 |
| 30218 | LUMINAIRES | 137 | 3125460302185 |
| 30219 | LUMINAIRES | 137 | 3125460302192 |
| 30220 | LUMINAIRES | 137 | 3125460302208 |
| 30221 | LUMINAIRES | 137 | 3125460302215 |
| 30222 | LUMINAIRES | 137 | 3125460302222 |
| 30223 | LUMINAIRES | 137 | 3125460302239 |
| 130601 | SOURCES | 139 | 3125461306014 |
| 130602 | SOURCES | 139 | 3125461306021 |
| 130603 | SOURCES | 139 | 3125461306038 |
| 130604 | SOURCES | 139 | 3125461306045 |
| 142529 | ACCESSOIRES | 195 | 3125461425296 |
| 142693 | ACCESSOIRES | 116 | 3125461426934 |
| 153373 | ACCESSOIRES | 122 | 3125461533731 |

New
New
New
New

New
New
New
New

| Ref. | CATALOGUE | PAGE | EAN |
|--------|-------------|------|---------------|
| 155463 | ACCESSOIRES | 156 | 3125461554637 |
| 155559 | LUMINAIRES | 105 | 3125461555597 |
| 155560 | LUMINAIRES | 102 | 3125461555603 |
| 155561 | LUMINAIRES | 105 | 3125461555610 |
| 155564 | LUMINAIRES | 102 | 3125461555641 |
| 155566 | LUMINAIRES | 102 | 3125461555665 |
| 155567 | LUMINAIRES | 105 | 3125461555672 |
| 155569 | LUMINAIRES | 107 | 3125461555696 |
| 155570 | LUMINAIRES | 56 | 3125461555702 |
| 155731 | ACCESSOIRES | 156 | 3125461557317 |
| 155733 | ACCESSOIRES | 156 | 3125461557331 |
| 155735 | ACCESSOIRES | 156 | 3125461557355 |
| 155736 | ACCESSOIRES | 157 | 3125461557362 |
| 155737 | ACCESSOIRES | 157 | 3125461557379 |
| 155738 | ACCESSOIRES | 157 | 3125461557386 |
| 157163 | ACCESSOIRES | 120 | 3125461571634 |
| 158009 | LUMINAIRES | 170 | 3125461580094 |
| 158011 | LUMINAIRES | 170 | 3125461580117 |
| 158014 | LUMINAIRES | 170 | 3125461580148 |
| 158016 | LUMINAIRES | 170 | 3125461580162 |
| 158018 | SOURCES | 80 | 3125461580186 |
| 158018 | LUMINAIRES | 172 | 3125461580186 |
| 158019 | SOURCES | 80 | 3125461580193 |
| 158019 | LUMINAIRES | 172 | 3125461580193 |
| 158020 | SOURCES | 80 | 3125461580209 |
| 158020 | LUMINAIRES | 172 | 3125461580209 |
| 158022 | SOURCES | 80 | 3125461580223 |
| 158022 | LUMINAIRES | 172 | 3125461580223 |
| 158063 | ACCESSOIRES | 92 | 3125461580636 |
| 158206 | LUMINAIRES | 101 | 3125461582067 |
| 158265 | ACCESSOIRES | 126 | 3125461582654 |
| 158267 | ACCESSOIRES | 126 | 3125461582678 |
| 158269 | ACCESSOIRES | 126 | 3125461582692 |
| 158339 | LUMINAIRES | 101 | 3125461583392 |
| 158459 | ACCESSOIRES | 126 | 3125461584597 |
| 158481 | LUMINAIRES | 106 | 3125461584818 |
| 158461 | ACCESSOIRES | 126 | 3125461584610 |
| 158482 | LUMINAIRES | 106 | 3125461584825 |
| 158463 | ACCESSOIRES | 126 | 3125461584634 |
| 158484 | LUMINAIRES | 106 | 3125461584849 |
| 158485 | LUMINAIRES | 107 | 3125461584856 |
| 158465 | ACCESSOIRES | 126 | 3125461584658 |
| 158487 | LUMINAIRES | 107 | 3125461584870 |
| 158495 | LUMINAIRES | 56 | 3125461584955 |
| 158530 | ACCESSOIRES | 126 | 3125461585303 |
| 158531 | ACCESSOIRES | 126 | 3125461585310 |
| 158532 | ACCESSOIRES | 127 | 3125461585327 |
| 158705 | ACCESSOIRES | 171 | 3125461587055 |
| 158844 | LUMINAIRES | 114 | 3125461588441 |

+

+

+

+

+

+

+

+

+

| Ref. | CATALOGUE | PAGE | EAN |
|--------|-------------|------|---------------|
| 158852 | ACCESSOIRES | 164 | 3125461588526 |
| 158858 | ACCESSOIRES | 165 | 3125461588588 |
| 158860 | ACCESSOIRES | 164 | 3125461588601 |
| 158872 | ACCESSOIRES | 28 | 3125461588724 |
| 158879 | LUMINAIRES | 145 | 3125461588793 |
| 158880 | LUMINAIRES | 145 | 3125461588809 |
| 160099 | SOURCES | 123 | 3125461600990 |
| 160101 | SOURCES | 124 | 3125461601010 |
| 160102 | SOURCES | 124 | 3125461601027 |
| 160103 | SOURCES | 123 | 3125461601034 |
| 160104 | SOURCES | 122 | 3125461601041 |
| 160105 | SOURCES | 122 | 3125461601058 |
| 160114 | SOURCES | 124 | 3125461601140 |
| 160115 | SOURCES | 123 | 3125461601157 |
| 160117 | SOURCES | 123 | 3125461601171 |
| 160122 | SOURCES | 128 | 3125461601225 |
| 160124 | SOURCES | 128 | 3125461601249 |
| 160134 | SOURCES | 123 | 3125461601348 |
| 160152 | SOURCES | 128 | 3125461601522 |
| 160171 | SOURCES | 128 | 3125461601713 |
| 160173 | SOURCES | 124 | 3125461601737 |
| 160192 | SOURCES | 123 | 3125461601928 |
| 160194 | SOURCES | 122 | 3125461601942 |
| 160198 | SOURCES | 123 | 3125461601980 |
| 160200 | SOURCES | 123 | 3125461602000 |
| 160203 | SOURCES | 129 | 3125461602031 |
| 160204 | SOURCES | 129 | 3125461602048 |
| 160205 | SOURCES | 128 | 3125461602055 |
| 160211 | SOURCES | 134 | 3125461602116 |
| 160212 | SOURCES | 134 | 3125461602123 |
| 161152 | LUMINAIRES | 84 | 3125461611521 |
| 161153 | LUMINAIRES | 84 | 3125461611538 |
| 161154 | LUMINAIRES | 84 | 3125461611545 |
| 161156 | SOURCES | 136 | 3125461611569 |
| 161158 | LUMINAIRES | 84 | 3125461611583 |
| 161159 | LUMINAIRES | 84 | 3125461611590 |
| 161162 | LUMINAIRES | 86 | 3125461611620 |
| 161163 | SOURCES | 136 | 3125461611637 |
| 161164 | LUMINAIRES | 86 | 3125461611644 |
| 161165 | SOURCES | 136 | 3125461611651 |
| 161166 | LUMINAIRES | 87 | 3125461611668 |
| 161167 | LUMINAIRES | 87 | 3125461611675 |
| 161168 | LUMINAIRES | 86 | 3125461611682 |
| 161169 | LUMINAIRES | 87 | 3125461611699 |
| 161170 | LUMINAIRES | 86 | 3125461611705 |
| 161171 | SOURCES | 136 | 3125461611712 |
| 161173 | SOURCES | 136 | 3125461611736 |
| 161174 | LUMINAIRES | 87 | 3125461611743 |
| 161175 | LUMINAIRES | 86 | 3125461611750 |

New

Récapitulatif des références

| Ref. | CATALOGUE | PAGE | EAN |
|--------|------------|------|---------------|
| 161176 | LUMINAIRES | 86 | 3125461611767 |
| 161177 | LUMINAIRES | 86 | 3125461611774 |
| 161178 | LUMINAIRES | 86 | 3125461611781 |
| 161179 | LUMINAIRES | 87 | 3125461611798 |
| 161180 | LUMINAIRES | 154 | 3125461611804 |
| 161181 | LUMINAIRES | 154 | 3125461611811 |
| 161182 | LUMINAIRES | 154 | 3125461611828 |
| 161183 | LUMINAIRES | 154 | 3125461611835 |
| 161184 | LUMINAIRES | 154 | 3125461611842 |
| 161185 | LUMINAIRES | 87 | 3125461611859 |
| 161186 | LUMINAIRES | 87 | 3125461611866 |
| 161187 | LUMINAIRES | 154 | 3125461611873 |
| 161188 | LUMINAIRES | 87 | 3125461611880 |
| 161189 | LUMINAIRES | 86 | 3125461611897 |
| 161190 | LUMINAIRES | 87 | 3125461611903 |
| 161191 | LUMINAIRES | 86 | 3125461611910 |
| 161192 | LUMINAIRES | 87 | 3125461611927 |
| 161193 | SOURCES | 133 | 3125461611934 |
| 161194 | SOURCES | 133 | 3125461611941 |
| 161195 | LUMINAIRES | 86 | 3125461611958 |
| 161196 | LUMINAIRES | 87 | 3125461611965 |
| 161197 | LUMINAIRES | 86 | 3125461611972 |
| 161198 | LUMINAIRES | 87 | 3125461611989 |
| 161199 | LUMINAIRES | 86 | 3125461611996 |
| 161200 | LUMINAIRES | 87 | 3125461612009 |
| 161201 | LUMINAIRES | 84 | 3125461612016 |
| 161202 | LUMINAIRES | 84 | 3125461612023 |
| 161203 | SOURCES | 136 | 3125461612030 |
| 161204 | SOURCES | 136 | 3125461612047 |
| 161205 | SOURCES | 137 | 3125461612054 |
| 161206 | SOURCES | 137 | 3125461612061 |
| 161207 | SOURCES | 137 | 3125461612078 |
| 161208 | SOURCES | 139 | 3125461612085 |
| 161209 | SOURCES | 136 | 3125461612092 |
| 162027 | LUMINAIRES | 74 | 3125461620271 |
| 162040 | SOURCES | 81 | 3125461620400 |
| 162040 | LUMINAIRES | 173 | 3125461620400 |
| 162047 | LUMINAIRES | 73 | 3125461620479 |
| 163065 | SOURCES | 165 | 7640153464637 |
| 163071 | SOURCES | 166 | 7640153464699 |
| 163131 | SOURCES | 147 | 7640153468192 |
| 163132 | SOURCES | 147 | 7640153468208 |
| 163143 | SOURCES | 146 | 7640153468314 |
| 163145 | SOURCES | 146 | 7640153468338 |
| 163206 | SOURCES | 131 | 3125461632069 |
| 163348 | LUMINAIRES | 140 | 3125461633486 |
| 163349 | LUMINAIRES | 140 | 3125461633493 |
| 163352 | LUMINAIRES | 140 | 3125461633523 |
| 163353 | LUMINAIRES | 140 | 3125461633530 |

New
New
New
New
New

| Ref. | CATALOGUE | PAGE | EAN |
|--------|------------|------|---------------|
| 163354 | LUMINAIRES | 140 | 3125461633547 |
| 164118 | SOURCES | 72 | 3125461641184 |
| 164403 | LUMINAIRES | 109 | 3125461644031 |
| 164404 | LUMINAIRES | 109 | 3125461644048 |
| 164405 | LUMINAIRES | 109 | 3125461644055 |
| 164406 | LUMINAIRES | 111 | 3125461644062 |
| 164407 | LUMINAIRES | 109 | 3125461644079 |
| 164408 | LUMINAIRES | 109 | 3125461644086 |
| 164409 | LUMINAIRES | 109 | 3125461644093 |
| 164410 | LUMINAIRES | 111 | 3125461644109 |
| 164411 | LUMINAIRES | 111 | 3125461644116 |
| 164421 | LUMINAIRES | 109 | 3125461644215 |
| 164422 | LUMINAIRES | 109 | 3125461644222 |
| 164423 | LUMINAIRES | 109 | 3125461644239 |
| 164435 | LUMINAIRES | 110 | 3125461644352 |
| 164436 | LUMINAIRES | 110 | 3125461644369 |
| 164437 | LUMINAIRES | 110 | 3125461644376 |
| 164441 | LUMINAIRES | 111 | 3125461644413 |
| 164450 | LUMINAIRES | 110 | 3125461644505 |
| 164451 | LUMINAIRES | 110 | 3125461644512 |
| 164452 | LUMINAIRES | 110 | 3125461644529 |
| 164465 | LUMINAIRES | 110 | 3125461644659 |
| 164466 | LUMINAIRES | 110 | 3125461644666 |
| 164467 | LUMINAIRES | 110 | 3125461644673 |
| 164543 | LUMINAIRES | 183 | 3125461645434 |
| 164809 | LUMINAIRES | 115 | 3125461648091 |
| 164811 | LUMINAIRES | 115 | 3125461648114 |
| 164812 | LUMINAIRES | 115 | 3125461648121 |
| 164918 | SOURCES | 131 | 3125461649180 |
| 164931 | SOURCES | 129 | 3125461649319 |
| 164932 | SOURCES | 129 | 3125461649326 |
| 165408 | LUMINAIRES | 104 | 3125461654085 |
| 165409 | LUMINAIRES | 104 | 3125461654092 |
| 165423 | LUMINAIRES | 101 | 3125461654238 |
| 165424 | LUMINAIRES | 104 | 3125461654245 |
| 165425 | LUMINAIRES | 98 | 3125461654252 |
| 165456 | SOURCES | 96 | 3125461654566 |
| 165457 | SOURCES | 96 | 3125461654573 |
| 165458 | SOURCES | 90 | 3125461654580 |
| 165461 | SOURCES | 90 | 3125461654610 |
| 165462 | SOURCES | 96 | 3125461654627 |
| 165463 | SOURCES | 91 | 3125461654634 |
| 165470 | LUMINAIRES | 182 | 3125461654702 |
| 165471 | LUMINAIRES | 182 | 3125461654719 |
| 166051 | SOURCES | 128 | 3125461660512 |
| 166052 | SOURCES | 131 | 3125461660529 |
| 166062 | SOURCES | 128 | 3125461660628 |
| 166063 | SOURCES | 131 | 3125461660635 |
| 166096 | SOURCES | 134 | 3125461660963 |

+
+
+
+

| Ref. | CATALOGUE | PAGE | EAN |
|--------|------------|------|-----------------|
| 166097 | SOURCES | 134 | 3125461660970 |
| 166098 | SOURCES | 134 | 3125461660987 |
| 166099 | SOURCES | 134 | 3125461660994 |
| 166103 | LUMINAIRES | 69 | 3125461661038 |
| 166104 | LUMINAIRES | 69 | 31254 616 61045 |
| 166106 | LUMINAIRES | 69 | 3125461661069 |
| 166300 | LUMINAIRES | 68 | 3125461663001 |
| 166301 | LUMINAIRES | 68 | 3125461663018 |
| 166302 | LUMINAIRES | 68 | 3125461663025 |
| 167029 | LUMINAIRES | 99 | 3125461670290 |
| 167030 | LUMINAIRES | 99 | 3125461670306 |
| 167036 | LUMINAIRES | 100 | 3125461670368 |
| 167037 | LUMINAIRES | 100 | 3125461670375 |
| 167056 | LUMINAIRES | 100 | 3125461670566 |
| 167057 | LUMINAIRES | 99 | 3125461670573 |
| 167058 | LUMINAIRES | 99 | 3125461670580 |
| 167089 | LUMINAIRES | 99 | 3125461670894 |
| 167090 | LUMINAIRES | 99 | 3125461670900 |
| 167113 | LUMINAIRES | 98 | 3125461671136 |
| 167114 | LUMINAIRES | 98 | 3125461671143 |
| 167138 | SOURCES | 123 | 3125461671389 |
| 167139 | SOURCES | 123 | 3125461671396 |
| 167140 | SOURCES | 123 | 3125461671402 |
| 167183 | SOURCES | 135 | 3125461671839 |
| 167184 | SOURCES | 135 | 3125461671846 |
| 167185 | SOURCES | 135 | 3125461671853 |
| 167186 | SOURCES | 135 | 3125461671860 |
| 167187 | SOURCES | 135 | 3125461671877 |
| 167188 | SOURCES | 135 | 3125461671884 |
| 167193 | SOURCES | 122 | 3125461671938 |
| 167194 | SOURCES | 122 | 3125461671945 |
| 167195 | SOURCES | 122 | 3125461671952 |
| 167196 | SOURCES | 122 | 3125461671969 |
| 167197 | SOURCES | 123 | 3125461671976 |
| 167212 | SOURCES | 121 | 3125461672126 |
| 167222 | SOURCES | 121 | 3125461672225 |
| 167225 | LUMINAIRES | 60 | 3125461672256 |
| 167282 | SOURCES | 137 | 3125461672829 |
| 167288 | SOURCES | 137 | 3125461672881 |
| 167295 | LUMINAIRES | 62 | 3125461672959 |
| 167297 | LUMINAIRES | 62 | 3125461672973 |
| 167301 | LUMINAIRES | 77 | 3125461673017 |
| 167303 | LUMINAIRES | 77 | 3125461673031 |
| 167339 | LUMINAIRES | 52 | 3125461673390 |
| 167344 | LUMINAIRES | 52 | 3125461673444 |
| 167347 | LUMINAIRES | 73 | 3125461673475 |
| 167370 | SOURCES | 167 | 3125461673703 |
| 167377 | LUMINAIRES | 57 | 3125461673772 |
| 167379 | LUMINAIRES | 57 | 3125461673796 |

New
New
New
+
+
+
+

| Ref. | CATALOGUE | PAGE | EAN | |
|--------|-------------|------|---------------|---|
| 167380 | LUMINAIRES | 57 | 3125461673802 | + |
| 167382 | LUMINAIRES | 57 | 3125461673826 | |
| 167384 | LUMINAIRES | 57 | 3125461673840 | |
| 167385 | LUMINAIRES | 57 | 3125461673857 | |
| 167386 | LUMINAIRES | 57 | 3125461673864 | |
| 167387 | LUMINAIRES | 57 | 3125461673871 | |
| 167389 | LUMINAIRES | 57 | 3125461673895 | |
| 167390 | LUMINAIRES | 57 | 3125461673901 | + |
| 167400 | LUMINAIRES | 71 | 3125461674007 | |
| 167414 | LUMINAIRES | 156 | 3125461674144 | |
| 167416 | LUMINAIRES | 165 | 3125461674168 | |
| 167438 | ACCESSOIRES | 198 | 3125461674380 | |
| 167509 | LUMINAIRES | 71 | 3125461675097 | |
| 167510 | ACCESSOIRES | 53 | 3125461675103 | |
| 167511 | ACCESSOIRES | 53 | 3125461675110 | |
| 167512 | ACCESSOIRES | 53 | 3125461675127 | |
| 167513 | ACCESSOIRES | 53 | 3125461675134 | |
| 167518 | ACCESSOIRES | 57 | 3125461675189 | |
| 167519 | ACCESSOIRES | 57 | 3125461675196 | |
| 167539 | SOURCES | 122 | 3125461675394 | |
| 167540 | SOURCES | 123 | 3125461675400 | |
| 167541 | SOURCES | 123 | 3125461675417 | |
| 167544 | SOURCES | 122 | 3125461675448 | |
| 167545 | SOURCES | 123 | 3125461675455 | |
| 167550 | SOURCES | 124 | 3125461675509 | |
| 167552 | SOURCES | 123 | 3125461675523 | |
| 167554 | SOURCES | 123 | 3125461675547 | |
| 167558 | SOURCES | 123 | 3125461675585 | |
| 168170 | LUMINAIRES | 62 | 3125461681708 | + |
| 168171 | LUMINAIRES | 62 | 3125461681715 | + |
| 168172 | LUMINAIRES | 63 | 3125461681722 | + |
| 168173 | LUMINAIRES | 63 | 3125461681739 | + |
| 168174 | LUMINAIRES | 64 | 3125461681746 | + |
| 168175 | LUMINAIRES | 64 | 3125461681753 | + |
| 168176 | LUMINAIRES | 64 | 3125461681760 | + |
| 168868 | LUMINAIRES | 71 | 3125461688684 | |
| 168885 | LUMINAIRES | 157 | 3125461688851 | |
| 168886 | LUMINAIRES | 157 | 3125461688868 | |
| 168887 | LUMINAIRES | 157 | 3125461688875 | |
| 168888 | LUMINAIRES | 157 | 3125461688882 | |
| 168889 | LUMINAIRES | 158 | 3125461688899 | |
| 168890 | LUMINAIRES | 158 | 3125461688905 | |
| 168895 | LUMINAIRES | 162 | 3125461688950 | |
| 168896 | LUMINAIRES | 162 | 3125461688967 | |
| 168900 | LUMINAIRES | 163 | 3125461689001 | |
| 168901 | LUMINAIRES | 164 | 3125461689018 | |
| 168905 | LUMINAIRES | 162 | 3125461689056 | |
| 168907 | LUMINAIRES | 162 | 3125461689070 | |
| 168973 | LUMINAIRES | 150 | 3125461689735 | |

| Ref. | CATALOGUE | PAGE | EAN | |
|--------|------------|------|---------------|-----|
| 168987 | LUMINAIRES | 149 | 3125461689872 | |
| 168988 | LUMINAIRES | 149 | 3125461689889 | |
| 168990 | LUMINAIRES | 61 | 3125461689902 | |
| 168991 | LUMINAIRES | 61 | 3125461689919 | |
| 168992 | LUMINAIRES | 61 | 3125461689926 | |
| 168993 | LUMINAIRES | 61 | 3125461689933 | |
| 169006 | LUMINAIRES | 74 | 3125461690069 | |
| 169111 | LUMINAIRES | 56 | 3125461691110 | + |
| 169113 | LUMINAIRES | 56 | 3125461691134 | + |
| 169143 | LUMINAIRES | 95 | 3125461691431 | |
| 169144 | LUMINAIRES | 95 | 3125461691448 | |
| 169145 | LUMINAIRES | 95 | 3125461691455 | |
| 169147 | LUMINAIRES | 83 | 3125461691479 | |
| 169148 | LUMINAIRES | 83 | 3125461691486 | |
| 169166 | LUMINAIRES | 92 | 3125461691660 | |
| 169167 | LUMINAIRES | 92 | 3125461691677 | |
| 169168 | LUMINAIRES | 92 | 3125461691684 | |
| 169170 | LUMINAIRES | 62 | 3125461691707 | + |
| 169171 | LUMINAIRES | 62 | 3125461691714 | + |
| 169173 | LUMINAIRES | 62 | 3125461691738 | + |
| 169177 | LUMINAIRES | 185 | 3125461691776 | |
| 169178 | LUMINAIRES | 185 | 3125461691783 | |
| 169193 | LUMINAIRES | 54 | 3125461691936 | |
| 169194 | LUMINAIRES | 54 | 3125461691943 | |
| 169198 | LUMINAIRES | 60 | 3125461691981 | New |
| 169208 | LUMINAIRES | 81 | 3125461692087 | New |
| 169209 | LUMINAIRES | 81 | 3125461692094 | New |
| 169210 | LUMINAIRES | 82 | 3125461692100 | New |
| 169211 | LUMINAIRES | 82 | 3125461692117 | New |
| 169212 | LUMINAIRES | 82 | 3125461692124 | New |
| 169213 | LUMINAIRES | 82 | 3125461692131 | New |
| 169214 | LUMINAIRES | 81 | 3125461692148 | New |
| 169215 | LUMINAIRES | 81 | 3125461692155 | New |
| 169216 | LUMINAIRES | 81 | 3125461692162 | New |
| 169217 | LUMINAIRES | 81 | 3125461692179 | New |
| 169218 | LUMINAIRES | 81 | 3125461692186 | New |
| 169219 | LUMINAIRES | 81 | 3125461692193 | New |
| 169222 | LUMINAIRES | 92 | 3125461692223 | |
| 169223 | LUMINAIRES | 95 | 3125461692230 | |
| 169224 | LUMINAIRES | 129 | 3125461692247 | + |
| 169225 | LUMINAIRES | 129 | 3125461692254 | + |
| 169226 | LUMINAIRES | 129 | 3125461692261 | + |
| 169227 | LUMINAIRES | 129 | 3125461692278 | + |
| 169228 | LUMINAIRES | 130 | 3125461692285 | + |
| 169229 | LUMINAIRES | 130 | 3125461692292 | + |
| 169233 | LUMINAIRES | 130 | 3125461692339 | + |
| 169235 | LUMINAIRES | 128 | 3125461692353 | + |
| 169236 | LUMINAIRES | 128 | 3125461692360 | + |
| 169237 | LUMINAIRES | 128 | 3125461692377 | + |

| Ref. | CATALOGUE | PAGE | EAN | |
|--------|------------|------|---------------|-----|
| 169238 | LUMINAIRES | 130 | 3125461692384 | + |
| 169340 | LUMINAIRES | 53 | 3125461693404 | |
| 169342 | LUMINAIRES | 53 | 3125461693428 | |
| 169366 | LUMINAIRES | 52 | 3125461693664 | |
| 169388 | LUMINAIRES | 50 | 3125461693886 | |
| 169399 | LUMINAIRES | 50 | 3125461693992 | |
| 169400 | LUMINAIRES | 50 | 3125461694005 | |
| 169404 | LUMINAIRES | 70 | 3125461694043 | |
| 169405 | LUMINAIRES | 160 | 3125461694050 | |
| 169406 | LUMINAIRES | 70 | 3125461694067 | |
| 169407 | LUMINAIRES | 160 | 3125461694074 | |
| 169408 | LUMINAIRES | 161 | 3125461694081 | |
| 169409 | LUMINAIRES | 161 | 3125461694098 | |
| 169410 | LUMINAIRES | 159 | 3125461694104 | |
| 169411 | LUMINAIRES | 159 | 3125461694111 | |
| 169412 | LUMINAIRES | 159 | 3125461694128 | |
| 169413 | LUMINAIRES | 159 | 3125461694135 | |
| 169436 | LUMINAIRES | 127 | 3125461694364 | + |
| 169444 | LUMINAIRES | 75 | 3125461694449 | |
| 169445 | LUMINAIRES | 75 | 3125461694456 | |
| 169500 | LUMINAIRES | 125 | 3125461695002 | + |
| 169501 | LUMINAIRES | 127 | 3125461695019 | + |
| 169502 | LUMINAIRES | 127 | 3125461695026 | + |
| 169503 | LUMINAIRES | 126 | 3125461695033 | + |
| 169504 | LUMINAIRES | 127 | 3125461695040 | + |
| 169505 | LUMINAIRES | 126 | 3125461695057 | + |
| 169506 | LUMINAIRES | 125 | 3125461695064 | + |
| 169507 | LUMINAIRES | 126 | 3125461695071 | + |
| 169508 | LUMINAIRES | 126 | 3125461695088 | + |
| 169509 | LUMINAIRES | 126 | 3125461695095 | + |
| 169510 | LUMINAIRES | 125 | 3125461695101 | + |
| 169511 | LUMINAIRES | 125 | 3125461695118 | + |
| 169603 | LUMINAIRES | 124 | 3125461696030 | New |
| 169604 | LUMINAIRES | 124 | 3125461696047 | New |
| 169605 | LUMINAIRES | 80 | 3125461696054 | New |
| 169606 | LUMINAIRES | 80 | 3125461696061 | New |
| 169607 | LUMINAIRES | 148 | 3125461696078 | New |
| 169608 | LUMINAIRES | 148 | 3125461696085 | New |
| 169621 | LUMINAIRES | 121 | 3125461696214 | New |
| 169622 | LUMINAIRES | 121 | 3125461696221 | New |
| 169623 | LUMINAIRES | 121 | 3125461696238 | New |
| 169624 | LUMINAIRES | 120 | 3125461696245 | New |
| 169625 | LUMINAIRES | 120 | 3125461696252 | New |
| 169626 | LUMINAIRES | 120 | 3125461696269 | New |
| 169627 | LUMINAIRES | 120 | 3125461696276 | New |
| 169628 | LUMINAIRES | 120 | 3125461696283 | New |
| 169629 | LUMINAIRES | 120 | 3125461696290 | New |
| 169630 | LUMINAIRES | 120 | 3125461696306 | New |
| 169631 | LUMINAIRES | 120 | 3125461696313 | New |

Récapitulatif des références

| Ref. | CATALOGUE | PAGE | EAN | | Ref. | CATALOGUE | PAGE | EAN | | Ref. | CATALOGUE | PAGE | EAN |
|--------|-------------|------|---------------|-----|--------|-------------|------|---------------|-----|--------|-------------|------|---------------|
| 169636 | LUMINAIRES | 122 | 3125461696368 | New | 174161 | ACCESSOIRES | 64 | 3125461741617 | | 187562 | ACCESSOIRES | 57 | 3125461875626 |
| 169637 | LUMINAIRES | 122 | 3125461696375 | New | 174162 | ACCESSOIRES | 64 | 3125461741624 | | 187563 | ACCESSOIRES | 63 | 3125461875633 |
| 169638 | LUMINAIRES | 122 | 3125461696382 | New | 174200 | SOURCES | 36 | 3125461742003 | New | 187564 | ACCESSOIRES | 95 | 3125461875640 |
| 169639 | LUMINAIRES | 122 | 3125461696399 | New | 174201 | SOURCES | 36 | 3125461742010 | New | 187568 | ACCESSOIRES | 96 | 3125461875688 |
| 169640 | LUMINAIRES | 123 | 3125461696405 | New | 174202 | SOURCES | 36 | 3125461742027 | New | 187569 | ACCESSOIRES | 96 | 3125461875695 |
| 169641 | LUMINAIRES | 123 | 3125461696412 | New | 174203 | SOURCES | 36 | 3125461742034 | New | 187570 | ACCESSOIRES | 96 | 3125461875701 |
| 169642 | LUMINAIRES | 123 | 3125461696429 | New | 174204 | SOURCES | 40 | 3125461742041 | New | 187571 | ACCESSOIRES | 96 | 3125461875718 |
| 169643 | LUMINAIRES | 123 | 3125461696436 | New | 174300 | SOURCES | 36 | 3125461743000 | New | 187572 | ACCESSOIRES | 76 | 3125461875725 |
| 169644 | LUMINAIRES | 119 | 3125461696443 | New | 174301 | SOURCES | 36 | 3125461743017 | New | 187573 | ACCESSOIRES | 76 | 3125461875732 |
| 169645 | LUMINAIRES | 119 | 3125461696450 | New | 174302 | SOURCES | 36 | 3125461743024 | New | 187574 | ACCESSOIRES | 80 | 3125461875749 |
| 169646 | LUMINAIRES | 119 | 3125461696467 | New | 187515 | ACCESSOIRES | 60 | 3125461875152 | | 187575 | ACCESSOIRES | 80 | 3125461875756 |
| 169647 | LUMINAIRES | 119 | 3125461696474 | New | 187516 | ACCESSOIRES | 60 | 3125461875169 | | 187576 | ACCESSOIRES | 80 | 3125461875763 |
| 169648 | LUMINAIRES | 119 | 3125461696481 | New | 187517 | ACCESSOIRES | 60 | 3125461875176 | | 187577 | ACCESSOIRES | 80 | 3125461875770 |
| 169649 | LUMINAIRES | 119 | 3125461696498 | New | 187518 | ACCESSOIRES | 74 | 3125461875183 | | 187578 | ACCESSOIRES | 80 | 3125461875787 |
| 169664 | LUMINAIRES | 166 | 3125461696641 | New | 187519 | ACCESSOIRES | 74 | 3125461875190 | | 187580 | ACCESSOIRES | 131 | 3125461875800 |
| 169665 | LUMINAIRES | 166 | 3125461696658 | New | 187520 | ACCESSOIRES | 74 | 3125461875206 | | 187581 | ACCESSOIRES | 131 | 3125461875817 |
| 169666 | LUMINAIRES | 166 | 3125461696665 | New | 187521 | ACCESSOIRES | 74 | 3125461875213 | | 187582 | ACCESSOIRES | 131 | 3125461875824 |
| 169667 | LUMINAIRES | 166 | 3125461696672 | New | 187522 | ACCESSOIRES | 76 | 3125461875220 | | 187584 | ACCESSOIRES | 45 | 3125461875848 |
| 169668 | LUMINAIRES | 166 | 3125461696689 | New | 187523 | ACCESSOIRES | 76 | 3125461875237 | | 187585 | ACCESSOIRES | 62 | 3125461875855 |
| 169669 | LUMINAIRES | 166 | 3125461696696 | New | 187524 | ACCESSOIRES | 76 | 3125461875244 | | 187586 | ACCESSOIRES | 45 | 3125461875862 |
| 169705 | LUMINAIRES | 80 | 3125461697051 | New | 187525 | ACCESSOIRES | 78 | 3125461875251 | | 187588 | ACCESSOIRES | 43 | 3125461875886 |
| 169706 | LUMINAIRES | 80 | 3125461697068 | New | 187526 | ACCESSOIRES | 78 | 3125461875268 | | 187589 | ACCESSOIRES | 43 | 3125461875893 |
| 169723 | LUMINAIRES | 121 | 3125461697235 | New | 187527 | ACCESSOIRES | 78 | 3125461875275 | | 187590 | ACCESSOIRES | 213 | 3125461875909 |
| 174110 | SOURCES | 44 | 3125461741105 | | 187528 | ACCESSOIRES | 78 | 3125461875282 | | 187591 | ACCESSOIRES | 213 | 3125461875916 |
| 174111 | SOURCES | 44 | 3125461741112 | | 187529 | ACCESSOIRES | 78 | 3125461875299 | | 187596 | ACCESSOIRES | 43 | 3125461875961 |
| 174112 | SOURCES | 48 | 3125461741129 | | 187531 | ACCESSOIRES | 130 | 3125461875312 | | 187597 | ACCESSOIRES | 43 | 3125461875978 |
| 174114 | SOURCES | 67 | 3125461741143 | | 187532 | ACCESSOIRES | 133 | 3125461875329 | | 187598 | ACCESSOIRES | 133 | 3125461875985 |
| 174115 | SOURCES | 67 | 3125461741150 | | 187533 | ACCESSOIRES | 131 | 3125461875336 | | 187599 | ACCESSOIRES | 70 | 3125461875992 |
| 174116 | SOURCES | 67 | 3125461741167 | | 187534 | ACCESSOIRES | 130 | 3125461875343 | | 187610 | ACCESSOIRES | 82 | 3125461876104 |
| 174117 | SOURCES | 56 | 3125461741174 | | 187535 | ACCESSOIRES | 130 | 3125461875350 | | 187612 | ACCESSOIRES | 83 | 3125461876128 |
| 174118 | SOURCES | 56 | 3125461741181 | | 187536 | ACCESSOIRES | 131 | 3125461875367 | | 187613 | ACCESSOIRES | 83 | 3125461876135 |
| 174119 | SOURCES | 56 | 3125461741198 | | 187537 | ACCESSOIRES | 130 | 3125461875374 | | 187614 | ACCESSOIRES | 83 | 3125461876142 |
| 174121 | SOURCES | 70 | 3125461741211 | | 187538 | ACCESSOIRES | 130 | 3125461875381 | | 187615 | ACCESSOIRES | 83 | 3125461876159 |
| 174125 | SOURCES | 48 | 3125461741259 | New | 187539 | ACCESSOIRES | 131 | 3125461875398 | | 187616 | ACCESSOIRES | 83 | 3125461876166 |
| 174126 | SOURCES | 46 | 3125461741266 | New | 187540 | ACCESSOIRES | 92 | 3125461875404 | | 187617 | ACCESSOIRES | 83 | 3125461876173 |
| 174127 | SOURCES | 46 | 3125461741273 | New | 187541 | ACCESSOIRES | 92 | 3125461875411 | | 189601 | ACCESSOIRES | 130 | 3125461896010 |
| 174128 | SOURCES | 46 | 3125461741280 | New | 187542 | ACCESSOIRES | 92 | 3125461875428 | | 189604 | ACCESSOIRES | 131 | 3125461896041 |
| 174130 | ACCESSOIRES | 35 | 3125461741303 | | 187543 | ACCESSOIRES | 97 | 3125461875435 | | 189605 | ACCESSOIRES | 131 | 3125461896058 |
| 174135 | LUMINAIRES | 179 | 3125461741358 | | 187544 | ACCESSOIRES | 97 | 3125461875442 | | 189607 | ACCESSOIRES | 131 | 3125461896072 |
| 174140 | SOURCES | 46 | 3125461741402 | | 187546 | ACCESSOIRES | 96 | 3125461875466 | | 189608 | ACCESSOIRES | 131 | 3125461896089 |
| 174141 | SOURCES | 46 | 3125461741419 | | 187547 | ACCESSOIRES | 95 | 3125461875473 | | 189609 | ACCESSOIRES | 131 | 3125461896096 |
| 174150 | ACCESSOIRES | 22 | 3125461741501 | | 187548 | ACCESSOIRES | 95 | 3125461875480 | | 189610 | ACCESSOIRES | 133 | 3125461896102 |
| 174151 | ACCESSOIRES | 22 | 3125461741518 | | 187549 | ACCESSOIRES | 95 | 3125461875497 | | 189614 | ACCESSOIRES | 133 | 3125461896140 |
| 174152 | ACCESSOIRES | 23 | 3125461741525 | | 187550 | ACCESSOIRES | 97 | 3125461875503 | | 189617 | ACCESSOIRES | 133 | 3125461896171 |
| 174153 | ACCESSOIRES | 23 | 3125461741532 | | 187551 | ACCESSOIRES | 97 | 3125461875510 | | 189623 | ACCESSOIRES | 131 | 3125461896232 |
| 174154 | ACCESSOIRES | 23 | 3125461741549 | | 187552 | ACCESSOIRES | 95 | 3125461875527 | | 189624 | ACCESSOIRES | 130 | 3125461896249 |
| 174155 | ACCESSOIRES | 24 | 3125461741556 | | 187553 | ACCESSOIRES | 97 | 3125461875534 | | 189625 | ACCESSOIRES | 131 | 3125461896256 |
| 174156 | ACCESSOIRES | 24 | 3125461741563 | | 187554 | ACCESSOIRES | 92 | 3125461875541 | | 189626 | ACCESSOIRES | 131 | 3125461896263 |
| 174160 | ACCESSOIRES | 64 | 3125461741600 | | 187557 | ACCESSOIRES | 58 | 3125461875572 | | 189627 | ACCESSOIRES | 131 | 3125461896270 |

| Ref. | CATALOGUE | PAGE | EAN |
|--------|-------------|------|---------------|
| 189629 | ACCESSOIRES | 131 | 3125461896294 |
| 189631 | ACCESSOIRES | 130 | 3125461896317 |
| 189632 | ACCESSOIRES | 131 | 3125461896324 |
| 189633 | ACCESSOIRES | 131 | 3125461896331 |
| 189634 | ACCESSOIRES | 131 | 3125461896348 |
| 189636 | ACCESSOIRES | 133 | 3125461896362 |
| 189637 | ACCESSOIRES | 131 | 3125461896379 |
| 189638 | ACCESSOIRES | 131 | 3125461896386 |
| 189639 | ACCESSOIRES | 131 | 3125461896393 |
| 189640 | ACCESSOIRES | 131 | 3125461896409 |
| 189643 | ACCESSOIRES | 131 | 3125461896430 |
| 189650 | ACCESSOIRES | 133 | 3125461896508 |
| 189651 | ACCESSOIRES | 133 | 3125461896515 |
| 200106 | ACCESSOIRES | 230 | 3125462001062 |
| 200107 | ACCESSOIRES | 230 | 3125462001079 |
| 200108 | ACCESSOIRES | 230 | 3125462001086 |
| 200109 | ACCESSOIRES | 230 | 3125462001093 |
| 200110 | ACCESSOIRES | 230 | 3125462001109 |
| 200112 | ACCESSOIRES | 230 | 3125462001123 |
| 200118 | ACCESSOIRES | 230 | 3125462001185 |
| 200121 | ACCESSOIRES | 230 | 3125462001215 |
| 200143 | ACCESSOIRES | 231 | 3125462001437 |
| 200145 | ACCESSOIRES | 231 | 3125462001451 |
| 200148 | ACCESSOIRES | 231 | 3125462001482 |
| 200151 | ACCESSOIRES | 231 | 3125462001512 |
| 200153 | ACCESSOIRES | 231 | 3125462001536 |
| 200216 | ACCESSOIRES | 231 | 3125462002168 |
| 200237 | ACCESSOIRES | 231 | 3125462002373 |
| 200248 | ACCESSOIRES | 231 | 3125462002489 |
| 200249 | ACCESSOIRES | 231 | 3125462002496 |
| 200250 | ACCESSOIRES | 231 | 3125462002502 |
| 200345 | ACCESSOIRES | 231 | 3125462003455 |
| 200347 | ACCESSOIRES | 231 | 3125462003479 |
| 200348 | ACCESSOIRES | 231 | 3125462003486 |
| 200349 | ACCESSOIRES | 231 | 3125462003493 |
| 200350 | ACCESSOIRES | 231 | 3125462003509 |
| 200600 | ACCESSOIRES | 169 | 3125462006005 |
| 200601 | ACCESSOIRES | 169 | 3125462006012 |
| 200602 | ACCESSOIRES | 169 | 3125462006029 |
| 200603 | ACCESSOIRES | 169 | 3125462006036 |
| 200604 | ACCESSOIRES | 168 | 3125462006043 |
| 200605 | ACCESSOIRES | 168 | 3125462006050 |
| 200606 | ACCESSOIRES | 168 | 3125462006067 |
| 200607 | ACCESSOIRES | 168 | 3125462006074 |
| 200700 | ACCESSOIRES | 69 | 3125462007002 |
| 200800 | ACCESSOIRES | 31 | 3125462008009 |
| 200801 | ACCESSOIRES | 31 | 3125462008016 |
| 200802 | ACCESSOIRES | 31 | 3125462008023 |
| 200900 | ACCESSOIRES | 60 | 3125462009006 |

New

New

| Ref. | CATALOGUE | PAGE | EAN |
|--------|-------------|------|---------------|
| 200901 | ACCESSOIRES | 60 | 3125462009013 |
| 201047 | ACCESSOIRES | 232 | 3125462010477 |
| 201059 | ACCESSOIRES | 232 | 3125462010590 |
| 201062 | ACCESSOIRES | 232 | 3125462010620 |
| 201072 | ACCESSOIRES | 232 | 3125462010729 |
| 201084 | ACCESSOIRES | 232 | 3125462010842 |
| 201096 | ACCESSOIRES | 232 | 3125462010965 |
| 202017 | ACCESSOIRES | 231 | 3125462020179 |
| 202019 | ACCESSOIRES | 231 | 3125462020193 |
| 202041 | ACCESSOIRES | 230 | 3125462020414 |
| 202052 | ACCESSOIRES | 231 | 3125462020520 |
| 202074 | ACCESSOIRES | 231 | 3125462020742 |
| 202246 | ACCESSOIRES | 231 | 3125462022463 |
| 202259 | ACCESSOIRES | 231 | 3125462022593 |
| 204633 | ACCESSOIRES | 236 | 3125462046339 |
| 204637 | ACCESSOIRES | 236 | 3125462046377 |
| 204638 | ACCESSOIRES | 236 | 3125462046384 |
| 204639 | ACCESSOIRES | 236 | 3125462046391 |
| 205727 | ACCESSOIRES | 235 | 3125462057274 |
| 205743 | ACCESSOIRES | 235 | 3125462057434 |
| 206850 | ACCESSOIRES | 235 | 3125462068508 |
| 206877 | ACCESSOIRES | 235 | 3125462068775 |
| 206893 | ACCESSOIRES | 235 | 3125462068935 |
| 210206 | ACCESSOIRES | 116 | 3125462102066 |
| 210215 | ACCESSOIRES | 116 | 3125462102158 |
| 210221 | ACCESSOIRES | 116 | 3125462102219 |
| 210226 | ACCESSOIRES | 116 | 3125462102264 |
| 210229 | ACCESSOIRES | 116 | 3125462102295 |
| 210247 | ACCESSOIRES | 117 | 3125462102479 |
| 210258 | ACCESSOIRES | 116 | 3125462102585 |
| 210298 | ACCESSOIRES | 117 | 3125462102981 |
| 210385 | ACCESSOIRES | 117 | 3125462103858 |
| 210571 | ACCESSOIRES | 120 | 3125462105715 |
| 210596 | ACCESSOIRES | 114 | 3125462105968 |
| 210597 | ACCESSOIRES | 114 | 3125462105975 |
| 210598 | ACCESSOIRES | 114 | 3125462105982 |
| 210599 | ACCESSOIRES | 114 | 3125462105999 |
| 210853 | ACCESSOIRES | 125 | 3125462108532 |
| 210879 | ACCESSOIRES | 112 | 3125462108792 |
| 210883 | ACCESSOIRES | 99 | 3125462108839 |
| 210884 | ACCESSOIRES | 99 | 3125462108846 |
| 210888 | ACCESSOIRES | 112 | 3125462108884 |
| 210889 | ACCESSOIRES | 112 | 3125462108891 |
| 210979 | ACCESSOIRES | 113 | 3125462109799 |
| 210988 | ACCESSOIRES | 113 | 3125462109881 |
| 210989 | ACCESSOIRES | 113 | 3125462109898 |
| 213051 | ACCESSOIRES | 106 | 3125462130519 |
| 213053 | ACCESSOIRES | 106 | 3125462130533 |
| 213057 | ACCESSOIRES | 106 | 3125462130571 |

| Ref. | CATALOGUE | PAGE | EAN |
|--------|-------------|------|---------------|
| 213151 | ACCESSOIRES | 106 | 3125462131516 |
| 213153 | ACCESSOIRES | 106 | 3125462131530 |
| 213157 | ACCESSOIRES | 106 | 3125462131578 |
| 213291 | ACCESSOIRES | 106 | 3125462132919 |
| 213293 | ACCESSOIRES | 106 | 3125462132933 |
| 213297 | ACCESSOIRES | 106 | 3125462132971 |
| 213361 | ACCESSOIRES | 108 | 3125462133619 |
| 213363 | ACCESSOIRES | 108 | 3125462133633 |
| 213501 | ACCESSOIRES | 107 | 3125462135019 |
| 214421 | ACCESSOIRES | 113 | 3125462144219 |
| 214423 | ACCESSOIRES | 113 | 3125462144233 |
| 214427 | ACCESSOIRES | 113 | 3125462144271 |
| 214444 | ACCESSOIRES | 113 | 3125462144448 |
| 214451 | ACCESSOIRES | 113 | 3125462144516 |
| 214453 | ACCESSOIRES | 113 | 3125462144530 |
| 214457 | ACCESSOIRES | 113 | 3125462144578 |
| 214513 | ACCESSOIRES | 109 | 3125462145131 |
| 214514 | ACCESSOIRES | 108 | 3125462145148 |
| 214534 | ACCESSOIRES | 108 | 3125462145346 |
| 214563 | ACCESSOIRES | 109 | 3125462145636 |
| 215163 | ACCESSOIRES | 110 | 3125462151637 |
| 215273 | ACCESSOIRES | 109 | 3125462152733 |
| 216091 | ACCESSOIRES | 104 | 3125462160912 |
| 216171 | ACCESSOIRES | 104 | 3125462161711 |
| 216173 | ACCESSOIRES | 110 | 3125462161735 |
| 216251 | ACCESSOIRES | 103 | 3125462162510 |
| 216351 | ACCESSOIRES | 102 | 3125462163517 |
| 216353 | ACCESSOIRES | 102 | 3125462163531 |
| 216357 | ACCESSOIRES | 102 | 3125462163579 |
| 216451 | ACCESSOIRES | 103 | 3125462164514 |
| 216457 | ACCESSOIRES | 103 | 3125462164576 |
| 216551 | ACCESSOIRES | 102 | 3125462165511 |
| 216553 | ACCESSOIRES | 102 | 3125462165535 |
| 216557 | ACCESSOIRES | 102 | 3125462165573 |
| 216651 | ACCESSOIRES | 102 | 3125462166518 |
| 216653 | ACCESSOIRES | 102 | 3125462166532 |
| 216657 | ACCESSOIRES | 102 | 3125462166570 |
| 216751 | ACCESSOIRES | 103 | 3125462167515 |
| 218401 | ACCESSOIRES | 113 | 3125462184017 |
| 218403 | ACCESSOIRES | 113 | 3125462184031 |
| 218407 | ACCESSOIRES | 113 | 3125462184079 |
| 218421 | ACCESSOIRES | 113 | 3125462184215 |
| 218423 | ACCESSOIRES | 113 | 3125462184239 |
| 218427 | ACCESSOIRES | 113 | 3125462184277 |
| 218433 | ACCESSOIRES | 113 | 3125462184338 |
| 219323 | ACCESSOIRES | 104 | 3125462193231 |
| 219331 | ACCESSOIRES | 99 | 3125462193316 |
| 219351 | ACCESSOIRES | 104 | 3125462193514 |
| 220879 | ACCESSOIRES | 112 | 3125462208799 |

Récapitulatif des références

| Ref. | CATALOGUE | PAGE | EAN |
|--------|-------------|------|---------------|
| 220881 | ACCESSOIRES | 112 | 3125462208812 |
| 220883 | ACCESSOIRES | 97 | 3125462208836 |
| 220884 | ACCESSOIRES | 97 | 3125462208843 |
| 220888 | ACCESSOIRES | 112 | 3125462208881 |
| 220889 | ACCESSOIRES | 112 | 3125462208898 |
| 220960 | ACCESSOIRES | 110 | 3125462209604 |
| 220969 | ACCESSOIRES | 112 | 3125462209697 |
| 220979 | ACCESSOIRES | 113 | 3125462209796 |
| 220981 | ACCESSOIRES | 113 | 3125462209819 |
| 220988 | ACCESSOIRES | 113 | 3125462209888 |
| 220989 | ACCESSOIRES | 113 | 3125462209895 |
| 221014 | ACCESSOIRES | 123 | 3125462210143 |
| 221123 | ACCESSOIRES | 122 | 3125462211232 |
| 221246 | ACCESSOIRES | 122 | 3125462212468 |
| 221343 | ACCESSOIRES | 123 | 3125462213434 |
| 221681 | ACCESSOIRES | 110 | 3125462216817 |
| 221860 | ACCESSOIRES | 122 | 3125462218606 |
| 230133 | ACCESSOIRES | 199 | 3125462301339 |
| 230313 | ACCESSOIRES | 199 | 3125462303135 |
| 230349 | ACCESSOIRES | 199 | 3125462303494 |
| 230461 | ACCESSOIRES | 199 | 3125462304613 |
| 230573 | ACCESSOIRES | 199 | 3125462305733 |
| 230591 | ACCESSOIRES | 199 | 3125462305917 |
| 230603 | ACCESSOIRES | 200 | 3125462306037 |
| 230611 | ACCESSOIRES | 200 | 3125462306112 |
| 230613 | ACCESSOIRES | 200 | 3125462306136 |
| 230619 | ACCESSOIRES | 200 | 3125462306198 |
| 230723 | ACCESSOIRES | 200 | 3125462307232 |
| 230731 | ACCESSOIRES | 200 | 3125462307317 |
| 230991 | ACCESSOIRES | 200 | 3125462309915 |
| 231003 | ACCESSOIRES | 201 | 3125462310034 |
| 231011 | ACCESSOIRES | 201 | 3125462310119 |
| 231029 | ACCESSOIRES | 201 | 3125462310294 |
| 231129 | ACCESSOIRES | 201 | 3125462311291 |
| 231139 | ACCESSOIRES | 201 | 3125462311390 |
| 231159 | ACCESSOIRES | 201 | 3125462311598 |
| 231494 | ACCESSOIRES | 202 | 3125462314940 |
| 231507 | ACCESSOIRES | 202 | 3125462315077 |
| 231614 | ACCESSOIRES | 202 | 3125462316142 |
| 231627 | ACCESSOIRES | 202 | 3125462316272 |
| 231637 | ACCESSOIRES | 202 | 3125462316371 |
| 231734 | ACCESSOIRES | 203 | 3125462317347 |
| 231747 | ACCESSOIRES | 203 | 3125462317477 |
| 231856 | ACCESSOIRES | 204 | 3125462318566 |
| 231869 | ACCESSOIRES | 204 | 3125462318696 |
| 231905 | ACCESSOIRES | 180 | 3125462319051 |
| 232561 | ACCESSOIRES | 204 | 3125462325618 |
| 232584 | ACCESSOIRES | 205 | 3125462325847 |
| 232604 | ACCESSOIRES | 205 | 3125462326042 |

| Ref. | CATALOGUE | PAGE | EAN |
|--------|-------------|------|---------------|
| 232609 | ACCESSOIRES | 205 | 3125462326097 |
| 232612 | ACCESSOIRES | 205 | 3125462326127 |
| 232617 | ACCESSOIRES | 205 | 3125462326172 |
| 232619 | ACCESSOIRES | 205 | 3125462326196 |
| 232763 | ACCESSOIRES | 198 | 3125462327636 |
| 232771 | ACCESSOIRES | 198 | 3125462327711 |
| 232803 | ACCESSOIRES | 198 | 3125462328039 |
| 232821 | ACCESSOIRES | 198 | 3125462328213 |
| 232837 | ACCESSOIRES | 198 | 3125462328374 |
| 232901 | ACCESSOIRES | 198 | 3125462329012 |
| 232911 | ACCESSOIRES | 198 | 3125462329111 |
| 232953 | ACCESSOIRES | 203 | 3125462329531 |
| 233353 | ACCESSOIRES | 114 | 3125462333538 |
| 233367 | ACCESSOIRES | 114 | 3125462333675 |
| 233469 | ACCESSOIRES | 206 | 3125462334696 |
| 233479 | ACCESSOIRES | 206 | 3125462334795 |
| 233481 | ACCESSOIRES | 206 | 3125462334818 |
| 233492 | ACCESSOIRES | 206 | 3125462334924 |
| 233502 | ACCESSOIRES | 208 | 3125462335020 |
| 233503 | ACCESSOIRES | 208 | 3125462335037 |
| 233505 | ACCESSOIRES | 208 | 3125462335051 |
| 233519 | ACCESSOIRES | 207 | 3125462335198 |
| 233538 | ACCESSOIRES | 206 | 3125462335389 |
| 233542 | ACCESSOIRES | 206 | 3125462335426 |
| 233705 | ACCESSOIRES | 208 | 3125462337055 |
| 233709 | ACCESSOIRES | 208 | 3125462337093 |
| 233717 | ACCESSOIRES | 208 | 3125462337178 |
| 233731 | ACCESSOIRES | 209 | 3125462337314 |
| 235011 | ACCESSOIRES | 137 | 3125462350115 |
| 235017 | ACCESSOIRES | 137 | 3125462350177 |
| 235025 | ACCESSOIRES | 137 | 3125462350252 |
| 235147 | ACCESSOIRES | 137 | 3125462351471 |
| 235753 | ACCESSOIRES | 139 | 3125462357534 |
| 235833 | ACCESSOIRES | 138 | 3125462358333 |
| 235841 | ACCESSOIRES | 138 | 3125462358418 |
| 235913 | ACCESSOIRES | 138 | 3125462359132 |
| 235921 | ACCESSOIRES | 138 | 3125462359217 |
| 235927 | ACCESSOIRES | 138 | 3125462359279 |
| 236243 | ACCESSOIRES | 137 | 3125462362439 |
| 236251 | ACCESSOIRES | 137 | 3125462362514 |
| 236257 | ACCESSOIRES | 137 | 3125462362576 |
| 236285 | ACCESSOIRES | 137 | 3125462362859 |
| 236373 | ACCESSOIRES | 138 | 3125462363733 |
| 236381 | ACCESSOIRES | 138 | 3125462363818 |
| 236387 | ACCESSOIRES | 138 | 3125462363870 |
| 236398 | ACCESSOIRES | 138 | 3125462363986 |
| 236527 | ACCESSOIRES | 139 | 3125462365270 |
| 236974 | ACCESSOIRES | 140 | 3125462369742 |
| 236982 | ACCESSOIRES | 139 | 3125462369827 |

| Ref. | CATALOGUE | PAGE | EAN |
|--------|-------------|------|---------------|
| 237043 | ACCESSOIRES | 135 | 3125462370434 |
| 237051 | ACCESSOIRES | 135 | 3125462370519 |
| 237062 | ACCESSOIRES | 135 | 3125462370625 |
| 237077 | ACCESSOIRES | 135 | 3125462370779 |
| 237079 | ACCESSOIRES | 135 | 3125462370793 |
| 237094 | ACCESSOIRES | 135 | 3125462370946 |
| 237133 | ACCESSOIRES | 136 | 3125462371332 |
| 237141 | ACCESSOIRES | 136 | 3125462371417 |
| 237142 | ACCESSOIRES | 136 | 3125462371424 |
| 237147 | ACCESSOIRES | 136 | 3125462371479 |
| 237149 | ACCESSOIRES | 136 | 3125462371493 |
| 237331 | ACCESSOIRES | 136 | 3125462373312 |
| 237457 | ACCESSOIRES | 136 | 3125462374579 |
| 237571 | ACCESSOIRES | 134 | 3125462375712 |
| 237577 | ACCESSOIRES | 134 | 3125462375774 |
| 237712 | ACCESSOIRES | 134 | 3125462377129 |
| 237881 | ACCESSOIRES | 134 | 3125462378812 |
| 237886 | ACCESSOIRES | 134 | 3125462378867 |
| 237893 | ACCESSOIRES | 134 | 3125462378935 |
| 237894 | ACCESSOIRES | 134 | 3125462378942 |
| 237895 | ACCESSOIRES | 134 | 3125462378959 |
| 237941 | ACCESSOIRES | 135 | 3125462379413 |
| 237942 | ACCESSOIRES | 135 | 3125462379420 |
| 237943 | ACCESSOIRES | 135 | 3125462379437 |
| 237944 | ACCESSOIRES | 135 | 3125462379444 |
| 237947 | ACCESSOIRES | 135 | 3125462379475 |
| 237949 | ACCESSOIRES | 135 | 3125462379499 |
| 240511 | ACCESSOIRES | 145 | 3125462405112 |
| 240523 | ACCESSOIRES | 144 | 3125462405235 |
| 240531 | ACCESSOIRES | 144 | 3125462405310 |
| 240540 | ACCESSOIRES | 144 | 3125462405402 |
| 240547 | ACCESSOIRES | 144 | 3125462405471 |
| 240573 | ACCESSOIRES | 145 | 3125462405730 |
| 240580 | ACCESSOIRES | 145 | 3125462405808 |
| 240581 | ACCESSOIRES | 145 | 3125462405815 |
| 240587 | ACCESSOIRES | 145 | 3125462405877 |
| 241001 | ACCESSOIRES | 144 | 3125462410017 |
| 241023 | ACCESSOIRES | 144 | 3125462410239 |
| 241040 | ACCESSOIRES | 144 | 3125462410406 |
| 241041 | ACCESSOIRES | 144 | 3125462410413 |
| 241313 | ACCESSOIRES | 147 | 3125462413131 |
| 241321 | ACCESSOIRES | 147 | 3125462413216 |
| 241350 | ACCESSOIRES | 147 | 3125462413506 |
| 241451 | ACCESSOIRES | 147 | 3125462414510 |
| 241467 | ACCESSOIRES | 147 | 3125462414671 |
| 241471 | ACCESSOIRES | 147 | 3125462414718 |
| 241563 | ACCESSOIRES | 146 | 3125462415630 |
| 241581 | ACCESSOIRES | 146 | 3125462415814 |
| 241604 | ACCESSOIRES | 63 | 3125462416040 |

| Ref. | CATALOGUE | PAGE | EAN |
|--------|-------------|------|---------------|
| 241605 | ACCESSOIRES | 63 | 3125462416057 |
| 241606 | ACCESSOIRES | 58 | 3125462416064 |
| 241607 | ACCESSOIRES | 57 | 3125462416071 |
| 241608 | ACCESSOIRES | 57 | 3125462416088 |
| 241611 | ACCESSOIRES | 148 | 3125462416118 |
| 241631 | ACCESSOIRES | 146 | 3125462416316 |
| 241633 | ACCESSOIRES | 148 | 3125462416330 |
| 241634 | ACCESSOIRES | 148 | 3125462416347 |
| 241635 | ACCESSOIRES | 148 | 3125462416354 |
| 241636 | ACCESSOIRES | 148 | 3125462416361 |
| 241638 | ACCESSOIRES | 148 | 3125462416385 |
| 241639 | ACCESSOIRES | 148 | 3125462416392 |
| 241851 | ACCESSOIRES | 66 | 3125462418518 |
| 241853 | ACCESSOIRES | 66 | 3125462418532 |
| 241857 | ACCESSOIRES | 66 | 3125462418570 |
| 241879 | ACCESSOIRES | 66 | 3125462418792 |
| 241880 | ACCESSOIRES | 66 | 3125462418808 |
| 241962 | ACCESSOIRES | 86 | 3125462419621 |
| 241974 | ACCESSOIRES | 86 | 3125462419744 |
| 241975 | ACCESSOIRES | 86 | 3125462419751 |
| 241983 | ACCESSOIRES | 86 | 3125462419836 |
| 241993 | ACCESSOIRES | 86 | 3125462419935 |
| 245115 | ACCESSOIRES | 158 | 3125462451157 |
| 245209 | ACCESSOIRES | 158 | 3125462452093 |
| 245443 | ACCESSOIRES | 158 | 3125462454431 |
| 245457 | ACCESSOIRES | 158 | 3125462454578 |
| 245465 | ACCESSOIRES | 158 | 3125462454653 |
| 245695 | ACCESSOIRES | 158 | 3125462456954 |
| 245795 | ACCESSOIRES | 161 | 3125462457951 |
| 245801 | ACCESSOIRES | 159 | 3125462458019 |
| 245803 | ACCESSOIRES | 159 | 3125462458033 |
| 245821 | ACCESSOIRES | 159 | 3125462458217 |
| 245823 | ACCESSOIRES | 159 | 3125462458231 |
| 245824 | ACCESSOIRES | 159 | 3125462458248 |
| 246051 | ACCESSOIRES | 160 | 3125462460517 |
| 246063 | ACCESSOIRES | 160 | 3125462460630 |
| 246077 | ACCESSOIRES | 160 | 3125462460777 |
| 246088 | ACCESSOIRES | 160 | 3125462460883 |
| 246751 | ACCESSOIRES | 157 | 3125462467516 |
| 246763 | ACCESSOIRES | 157 | 3125462467639 |
| 246941 | ACCESSOIRES | 158 | 3125462469411 |
| 246953 | ACCESSOIRES | 158 | 3125462469534 |
| 247325 | ACCESSOIRES | 161 | 3125462473258 |
| 247763 | ACCESSOIRES | 161 | 3125462477638 |
| 250554 | ACCESSOIRES | 152 | 3125462505546 |
| 250555 | ACCESSOIRES | 152 | 3125462505553 |
| 250556 | ACCESSOIRES | 152 | 3125462505560 |
| 250557 | ACCESSOIRES | 152 | 3125462505577 |
| 250781 | ACCESSOIRES | 152 | 3125462507816 |

New
New

| Ref. | CATALOGUE | PAGE | EAN |
|--------|-------------|------|---------------|
| 250784 | ACCESSOIRES | 153 | 3125462507847 |
| 250785 | ACCESSOIRES | 153 | 3125462507854 |
| 250786 | ACCESSOIRES | 152 | 3125462507861 |
| 250787 | ACCESSOIRES | 153 | 3125462507878 |
| 250788 | ACCESSOIRES | 153 | 3125462507885 |
| 250887 | ACCESSOIRES | 152 | 3125462508875 |
| 250891 | ACCESSOIRES | 152 | 3125462508912 |
| 250893 | ACCESSOIRES | 152 | 3125462508936 |
| 250897 | ACCESSOIRES | 152 | 3125462508974 |
| 252111 | ACCESSOIRES | 171 | 3125462521119 |
| 253003 | ACCESSOIRES | 125 | 3125462530036 |
| 253013 | ACCESSOIRES | 125 | 3125462530135 |
| 260001 | ACCESSOIRES | 164 | 3125462600012 |
| 260002 | ACCESSOIRES | 164 | 3125462600029 |
| 260003 | ACCESSOIRES | 164 | 3125462600036 |
| 260007 | ACCESSOIRES | 164 | 3125462600074 |
| 260011 | ACCESSOIRES | 149 | 3125462600111 |
| 260035 | ACCESSOIRES | 124 | 3125462600357 |
| 260049 | ACCESSOIRES | 124 | 3125462600494 |
| 260050 | ACCESSOIRES | 123 | 3125462600500 |
| 260056 | ACCESSOIRES | 124 | 3125462600562 |
| 260067 | ACCESSOIRES | 125 | 3125462600678 |
| 260078 | ACCESSOIRES | 125 | 3125462600784 |
| 260120 | ACCESSOIRES | 209 | 3125462601200 |
| 260721 | ACCESSOIRES | 165 | 3125462607219 |
| 260723 | ACCESSOIRES | 165 | 3125462607233 |
| 260727 | ACCESSOIRES | 165 | 3125462607271 |
| 260821 | ACCESSOIRES | 165 | 3125462608216 |
| 261122 | ACCESSOIRES | 149 | 3125462611223 |
| 261133 | ACCESSOIRES | 149 | 3125462611339 |
| 261137 | ACCESSOIRES | 149 | 3125462611377 |
| 262015 | ACCESSOIRES | 121 | 3125462620157 |
| 262046 | ACCESSOIRES | 121 | 3125462620461 |
| 262048 | ACCESSOIRES | 121 | 3125462620485 |
| 262049 | ACCESSOIRES | 120 | 3125462620492 |
| 262100 | ACCESSOIRES | 118 | 3125462621000 |
| 262171 | ACCESSOIRES | 118 | 3125462621710 |
| 262180 | ACCESSOIRES | 118 | 3125462621802 |
| 262185 | ACCESSOIRES | 118 | 3125462621857 |
| 266015 | LUMINAIRES | 114 | 3125462660153 |
| 269146 | ACCESSOIRES | 119 | 3125462691461 |
| 269147 | ACCESSOIRES | 119 | 3125462691478 |
| 269148 | ACCESSOIRES | 119 | 3125462691485 |
| 269150 | ACCESSOIRES | 119 | 3125462691508 |
| 269168 | ACCESSOIRES | 120 | 3125462691683 |
| 269176 | SOURCES | 40 | 3125462691768 |
| 269324 | ACCESSOIRES | 119 | 3125462693243 |
| 281492 | ACCESSOIRES | 174 | 3125462814921 |
| 281836 | ACCESSOIRES | 174 | 3125462818363 |

| Ref. | CATALOGUE | PAGE | EAN |
|--------|-------------|------|---------------|
| 282027 | ACCESSOIRES | 174 | 3125462820274 |
| 282039 | ACCESSOIRES | 174 | 3125462820397 |
| 282049 | ACCESSOIRES | 174 | 3125462820496 |
| 282171 | ACCESSOIRES | 174 | 3125462821714 |
| 282852 | ACCESSOIRES | 87 | 3125462828522 |
| 282963 | ACCESSOIRES | 87 | 3125462829635 |
| 283884 | ACCESSOIRES | 87 | 3125462838842 |
| 283895 | ACCESSOIRES | 87 | 3125462838958 |
| 285664 | ACCESSOIRES | 175 | 3125462856648 |
| 286230 | ACCESSOIRES | 175 | 3125462862304 |
| 287372 | ACCESSOIRES | 176 | 3125462873720 |
| 287594 | ACCESSOIRES | 176 | 3125462875946 |
| 287605 | ACCESSOIRES | 176 | 3125462876059 |
| 288272 | ACCESSOIRES | 176 | 3125462882722 |
| 288525 | ACCESSOIRES | 216 | 3125462885259 |
| 288636 | ACCESSOIRES | 216 | 3125462886362 |
| 288760 | ACCESSOIRES | 216 | 3125462887604 |
| 288869 | ACCESSOIRES | 216 | 3125462888694 |
| 289204 | ACCESSOIRES | 217 | 3125462892042 |
| 289205 | ACCESSOIRES | 217 | 3125462892059 |
| 289206 | ACCESSOIRES | 217 | 3125462892066 |
| 289658 | ACCESSOIRES | 216 | 3125462896583 |
| 290615 | ACCESSOIRES | 217 | 3125462906152 |
| 300101 | ACCESSOIRES | 92 | 3125463001016 |
| 300102 | ACCESSOIRES | 92 | 3125463001023 |
| 300200 | ACCESSOIRES | 51 | 3125463002006 |
| 300210 | ACCESSOIRES | 51 | 3125463002105 |
| 300211 | ACCESSOIRES | 51 | 3125463002112 |
| 300220 | ACCESSOIRES | 51 | 3125463002204 |
| 300221 | ACCESSOIRES | 51 | 3125463002211 |
| 300250 | ACCESSOIRES | 50 | 3125463002501 |
| 300251 | ACCESSOIRES | 50 | 3125463002518 |
| 300300 | ACCESSOIRES | 74 | 3125463003003 |
| 300301 | ACCESSOIRES | 74 | 3125463003010 |
| 300351 | ACCESSOIRES | 76 | 3125463003515 |
| 300352 | ACCESSOIRES | 76 | 3125463003522 |
| 300353 | ACCESSOIRES | 76 | 3125463003539 |
| 300354 | ACCESSOIRES | 76 | 3125463003546 |
| 300356 | ACCESSOIRES | 76 | 3125463003560 |
| 300357 | ACCESSOIRES | 76 | 3125463003577 |
| 300369 | ACCESSOIRES | 178 | 3125463003690 |
| 300370 | ACCESSOIRES | 178 | 3125463003706 |
| 300382 | ACCESSOIRES | 178 | 3125463003829 |
| 300410 | ACCESSOIRES | 62 | 3125463004109 |
| 300453 | ACCESSOIRES | 36 | 3125463004536 |
| 300454 | ACCESSOIRES | 36 | 3125463004543 |
| 300456 | ACCESSOIRES | 36 | 3125463004567 |
| 300475 | ACCESSOIRES | 27 | 3125463004758 |
| 300503 | ACCESSOIRES | 45 | 3125463005038 |

Récapitulatif des références

| Ref. | CATALOGUE | PAGE | EAN |
|--------|-------------|------|---------------|
| 300504 | ACCESSOIRES | 45 | 3125463005045 |
| 300600 | ACCESSOIRES | 96 | 3125463006004 |
| 300601 | ACCESSOIRES | 96 | 3125463006011 |
| 300602 | ACCESSOIRES | 96 | 3125463006028 |
| 300604 | ACCESSOIRES | 96 | 3125463006042 |
| 300611 | ACCESSOIRES | 95 | 3125463006110 |
| 300612 | ACCESSOIRES | 95 | 3125463006127 |
| 300613 | ACCESSOIRES | 95 | 3125463006134 |
| 300614 | ACCESSOIRES | 95 | 3125463006141 |
| 300616 | ACCESSOIRES | 95 | 3125463006165 |
| 300621 | ACCESSOIRES | 95 | 3125463006219 |
| 300622 | ACCESSOIRES | 95 | 3125463006226 |
| 300623 | ACCESSOIRES | 95 | 3125463006233 |
| 300624 | ACCESSOIRES | 95 | 3125463006240 |
| 300626 | ACCESSOIRES | 95 | 3125463006264 |
| 300627 | ACCESSOIRES | 95 | 3125463006271 |
| 300628 | ACCESSOIRES | 90 | 3125463006288 |
| 300629 | ACCESSOIRES | 90 | 3125463006295 |
| 300630 | ACCESSOIRES | 90 | 3125463006301 |
| 300702 | ACCESSOIRES | 76 | 3125463007025 |
| 300703 | ACCESSOIRES | 76 | 3125463007032 |
| 300704 | ACCESSOIRES | 76 | 3125463007049 |
| 300705 | ACCESSOIRES | 76 | 3125463007056 |
| 300706 | ACCESSOIRES | 74 | 3125463007063 |
| 300800 | ACCESSOIRES | 42 | 3125463008008 |
| 300802 | ACCESSOIRES | 42 | 3125463008022 |
| 300803 | ACCESSOIRES | 42 | 3125463008039 |
| 300804 | ACCESSOIRES | 42 | 3125463008046 |
| 300825 | ACCESSOIRES | 177 | 3125463008251 |
| 300903 | ACCESSOIRES | 42 | 3125463009036 |
| 301001 | ACCESSOIRES | 42 | 3125463010018 |
| 302001 | ACCESSOIRES | 130 | 3125463020017 |
| 302104 | ACCESSOIRES | 131 | 3125463021045 |
| 302105 | ACCESSOIRES | 131 | 3125463021052 |
| 302106 | ACCESSOIRES | 131 | 3125463021069 |
| 302107 | ACCESSOIRES | 131 | 3125463021076 |
| 302195 | ACCESSOIRES | 177 | 3125463021953 |
| 302201 | ACCESSOIRES | 130 | 3125463022011 |
| 302202 | ACCESSOIRES | 130 | 3125463022028 |
| 302203 | ACCESSOIRES | 130 | 3125463022035 |
| 302204 | ACCESSOIRES | 130 | 3125463022042 |
| 302257 | ACCESSOIRES | 179 | 3125463022578 |
| 302279 | ACCESSOIRES | 179 | 3125463022790 |
| 302281 | ACCESSOIRES | 179 | 3125463022813 |
| 302292 | ACCESSOIRES | 179 | 3125463022929 |
| 302303 | ACCESSOIRES | 179 | 3125463023032 |
| 302314 | ACCESSOIRES | 179 | 3125463023148 |
| 302325 | ACCESSOIRES | 179 | 3125463023254 |
| 302336 | ACCESSOIRES | 179 | 3125463023360 |

New

New

New

New

| Ref. | CATALOGUE | PAGE | EAN |
|--------|-------------|------|---------------|
| 302347 | ACCESSOIRES | 179 | 3125463023476 |
| 302448 | ACCESSOIRES | 179 | 3125463024480 |
| 302460 | ACCESSOIRES | 179 | 3125463024602 |
| 302471 | ACCESSOIRES | 179 | 3125463024718 |
| 302482 | ACCESSOIRES | 179 | 3125463024824 |
| 302493 | ACCESSOIRES | 179 | 3125463024930 |
| 302537 | ACCESSOIRES | 179 | 3125463025371 |
| 302548 | ACCESSOIRES | 179 | 3125463025487 |
| 302551 | ACCESSOIRES | 179 | 3125463025517 |
| 302554 | ACCESSOIRES | 179 | 3125463025548 |
| 302598 | ACCESSOIRES | 179 | 3125463025982 |
| 302643 | ACCESSOIRES | 179 | 3125463026439 |
| 303121 | ACCESSOIRES | 180 | 3125463031211 |
| 303598 | ACCESSOIRES | 180 | 3125463035981 |
| 303619 | ACCESSOIRES | 180 | 3125463036193 |
| 303620 | ACCESSOIRES | 180 | 3125463036209 |
| 303675 | ACCESSOIRES | 180 | 3125463036759 |
| 303731 | ACCESSOIRES | 182 | 3125463037312 |
| 303842 | ACCESSOIRES | 182 | 3125463038425 |
| 304126 | ACCESSOIRES | 183 | 3125463041265 |
| 304237 | ACCESSOIRES | 183 | 3125463042378 |
| 304561 | ACCESSOIRES | 183 | 3125463045614 |
| 304783 | ACCESSOIRES | 183 | 3125463047830 |
| 304894 | ACCESSOIRES | 183 | 3125463048943 |
| 304905 | ACCESSOIRES | 183 | 3125463049056 |
| 304916 | ACCESSOIRES | 183 | 3125463049162 |
| 304927 | ACCESSOIRES | 183 | 3125463049278 |
| 304938 | ACCESSOIRES | 183 | 3125463049384 |
| 305001 | ACCESSOIRES | 46 | 3125463050014 |
| 305002 | ACCESSOIRES | 46 | 3125463050021 |
| 305421 | ACCESSOIRES | 184 | 3125463054210 |
| 305467 | ACCESSOIRES | 184 | 3125463054678 |
| 305478 | ACCESSOIRES | 184 | 3125463054784 |
| 305590 | ACCESSOIRES | 184 | 3125463055903 |
| 305944 | ACCESSOIRES | 184 | 3125463059444 |
| 306340 | ACCESSOIRES | 184 | 3125463063403 |
| 306351 | ACCESSOIRES | 185 | 3125463063519 |
| 306359 | ACCESSOIRES | 184 | 3125463063595 |
| 306362 | ACCESSOIRES | 185 | 3125463063625 |
| 306473 | ACCESSOIRES | 185 | 3125463064738 |
| 306574 | ACCESSOIRES | 184 | 3125463065742 |
| 306796 | ACCESSOIRES | 185 | 3125463067968 |
| 306929 | ACCESSOIRES | 185 | 3125463069290 |
| 306930 | ACCESSOIRES | 185 | 3125463069306 |
| 307002 | ACCESSOIRES | 186 | 3125463070029 |
| 307013 | ACCESSOIRES | 186 | 3125463070135 |
| 307124 | ACCESSOIRES | 186 | 3125463071248 |
| 307346 | ACCESSOIRES | 186 | 3125463073464 |
| 307350 | ACCESSOIRES | 186 | 3125463073501 |

| Ref. | CATALOGUE | PAGE | EAN |
|--------|-------------|------|---------------|
| 307902 | ACCESSOIRES | 186 | 3125463079022 |
| 308136 | ACCESSOIRES | 186 | 3125463081360 |
| 308147 | ACCESSOIRES | 186 | 3125463081476 |
| 308470 | ACCESSOIRES | 187 | 3125463084705 |
| 308482 | ACCESSOIRES | 187 | 3125463084828 |
| 308692 | ACCESSOIRES | 187 | 3125463086921 |
| 308702 | ACCESSOIRES | 187 | 3125463087027 |
| 308713 | ACCESSOIRES | 187 | 3125463087133 |
| 309007 | ACCESSOIRES | 187 | 3125463090072 |
| 309420 | ACCESSOIRES | 188 | 3125463094209 |
| 309431 | ACCESSOIRES | 188 | 3125463094315 |
| 309442 | ACCESSOIRES | 188 | 3125463094421 |
| 309453 | ACCESSOIRES | 188 | 3125463094537 |
| 309464 | ACCESSOIRES | 188 | 3125463094643 |
| 309475 | ACCESSOIRES | 188 | 3125463094759 |
| 309486 | ACCESSOIRES | 188 | 3125463094865 |
| 309497 | ACCESSOIRES | 188 | 3125463094971 |
| 309509 | ACCESSOIRES | 188 | 3125463095091 |
| 309610 | ACCESSOIRES | 181 | 3125463096104 |
| 309721 | ACCESSOIRES | 181 | 3125463097217 |
| 309732 | ACCESSOIRES | 181 | 3125463097323 |
| 309765 | ACCESSOIRES | 181 | 3125463097651 |
| 310001 | ACCESSOIRES | 83 | 3125463100016 |
| 310002 | ACCESSOIRES | 83 | 3125463100023 |
| 310004 | ACCESSOIRES | 83 | 3125463100047 |
| 310005 | ACCESSOIRES | 83 | 3125463100054 |
| 310012 | ACCESSOIRES | 190 | 3125463100122 |
| 310034 | ACCESSOIRES | 190 | 3125463100344 |
| 310078 | ACCESSOIRES | 190 | 3125463100788 |
| 310089 | ACCESSOIRES | 190 | 3125463100894 |
| 310127 | ACCESSOIRES | 189 | 3125463101273 |
| 320000 | ACCESSOIRES | 170 | 3125463200006 |
| 320001 | ACCESSOIRES | 170 | 3125463200013 |
| 320486 | ACCESSOIRES | 190 | 3125463204868 |
| 320596 | ACCESSOIRES | 191 | 3125463205964 |
| 320719 | ACCESSOIRES | 191 | 3125463207197 |
| 321626 | ACCESSOIRES | 191 | 3125463216267 |
| 330215 | ACCESSOIRES | 192 | 3125463302151 |
| 330237 | ACCESSOIRES | 192 | 3125463302373 |
| 330359 | ACCESSOIRES | 192 | 3125463303592 |
| 330573 | ACCESSOIRES | 192 | 3125463305732 |
| 330697 | ACCESSOIRES | 192 | 3125463306975 |
| 330719 | ACCESSOIRES | 192 | 3125463307194 |
| 331728 | ACCESSOIRES | 181 | 3125463317285 |
| 331840 | ACCESSOIRES | 182 | 3125463318404 |
| 331951 | ACCESSOIRES | 182 | 3125463319517 |
| 331972 | ACCESSOIRES | 180 | 3125463319722 |
| 333000 | ACCESSOIRES | 38 | 3125463330000 |
| 333003 | ACCESSOIRES | 32 | 3125463330031 |

| Ref. | CATALOGUE | PAGE | EAN |
|--------|-------------|------|---------------|
| 335715 | ACCESSOIRES | 193 | 3125463357151 |
| 335726 | ACCESSOIRES | 193 | 3125463357267 |
| 336501 | ACCESSOIRES | 193 | 3125463365019 |
| 336674 | ACCESSOIRES | 195 | 3125463366740 |
| 336785 | ACCESSOIRES | 195 | 3125463367853 |
| 336907 | ACCESSOIRES | 195 | 3125463369079 |
| 337009 | ACCESSOIRES | 194 | 3125463370099 |
| 337010 | ACCESSOIRES | 194 | 3125463370105 |
| 337020 | ACCESSOIRES | 194 | 3125463370204 |
| 337034 | ACCESSOIRES | 194 | 3125463370341 |
| 337132 | ACCESSOIRES | 194 | 3125463371324 |
| 337724 | ACCESSOIRES | 193 | 3125463377241 |
| 340017 | ACCESSOIRES | 196 | 3125463400178 |
| 340039 | ACCESSOIRES | 196 | 3125463400390 |
| 340051 | ACCESSOIRES | 196 | 3125463400512 |
| 340073 | ACCESSOIRES | 196 | 3125463400734 |
| 340095 | ACCESSOIRES | 196 | 3125463400956 |
| 340137 | ACCESSOIRES | 196 | 3125463401373 |
| 340159 | ACCESSOIRES | 196 | 3125463401595 |
| 340171 | ACCESSOIRES | 196 | 3125463401717 |
| 340193 | ACCESSOIRES | 196 | 3125463401939 |
| 340215 | ACCESSOIRES | 196 | 3125463402158 |
| 340237 | ACCESSOIRES | 196 | 3125463402370 |
| 341012 | ACCESSOIRES | 195 | 3125463410122 |
| 341056 | ACCESSOIRES | 195 | 3125463410566 |
| 341190 | ACCESSOIRES | 195 | 3125463411907 |
| 341212 | ACCESSOIRES | 196 | 3125463412126 |
| 341234 | ACCESSOIRES | 196 | 3125463412348 |
| 342020 | ACCESSOIRES | 197 | 3125463420206 |
| 342142 | ACCESSOIRES | 196 | 3125463421425 |
| 342164 | ACCESSOIRES | 196 | 3125463421647 |
| 342186 | ACCESSOIRES | 196 | 3125463421869 |
| 342208 | ACCESSOIRES | 196 | 3125463422088 |
| 342230 | ACCESSOIRES | 196 | 3125463422309 |
| 342252 | ACCESSOIRES | 196 | 3125463422521 |
| 342274 | ACCESSOIRES | 196 | 3125463422743 |
| 342296 | ACCESSOIRES | 196 | 3125463422965 |
| 346425 | ACCESSOIRES | 197 | 3125463464255 |
| 346436 | ACCESSOIRES | 197 | 3125463464361 |
| 346447 | ACCESSOIRES | 197 | 3125463464477 |
| 346458 | ACCESSOIRES | 197 | 3125463464583 |
| 346469 | ACCESSOIRES | 197 | 3125463464699 |
| 346470 | ACCESSOIRES | 197 | 3125463464705 |
| 346481 | ACCESSOIRES | 197 | 3125463464811 |
| 346492 | ACCESSOIRES | 197 | 3125463464927 |
| 346513 | ACCESSOIRES | 197 | 3125463465139 |
| 346524 | ACCESSOIRES | 197 | 3125463465245 |
| 346546 | ACCESSOIRES | 197 | 3125463465467 |
| 346568 | ACCESSOIRES | 197 | 3125463465689 |

| Ref. | CATALOGUE | PAGE | EAN |
|--------|-------------|------|---------------|
| 346580 | ACCESSOIRES | 197 | 3125463465801 |
| 346591 | ACCESSOIRES | 197 | 3125463465917 |
| 346602 | ACCESSOIRES | 197 | 3125463466020 |
| 346613 | ACCESSOIRES | 197 | 3125463466136 |
| 346635 | ACCESSOIRES | 197 | 3125463466358 |
| 346657 | ACCESSOIRES | 197 | 3125463466570 |
| 346914 | ACCESSOIRES | 197 | 3125463469144 |
| 360301 | ACCESSOIRES | 227 | 3125463603012 |
| 365063 | ACCESSOIRES | 213 | 3125463650634 |
| 365074 | ACCESSOIRES | 213 | 3125463650740 |
| 365085 | ACCESSOIRES | 213 | 3125463650856 |
| 365096 | ACCESSOIRES | 213 | 3125463650962 |
| 380507 | ACCESSOIRES | 204 | 3125463805072 |
| 591010 | SOURCES | 166 | 3125465910101 |
| 700017 | ACCESSOIRES | 214 | 3125467000176 |
| 700028 | ACCESSOIRES | 214 | 3125467000282 |
| 700039 | ACCESSOIRES | 214 | 3125467000398 |
| 700040 | ACCESSOIRES | 214 | 3125467000404 |
| 700062 | ACCESSOIRES | 214 | 3125467000626 |
| 700084 | ACCESSOIRES | 214 | 3125467000848 |
| 700095 | ACCESSOIRES | 214 | 3125467000954 |
| 700101 | ACCESSOIRES | 215 | 3125467001012 |
| 700223 | ACCESSOIRES | 215 | 3125467002231 |
| 700245 | ACCESSOIRES | 215 | 3125467002453 |
| 700335 | ACCESSOIRES | 215 | 3125467003351 |
| 700346 | ACCESSOIRES | 215 | 3125467003467 |
| 700379 | ACCESSOIRES | 215 | 3125467003795 |
| 700448 | ACCESSOIRES | 227 | 3125467004488 |
| 700761 | ACCESSOIRES | 227 | 3125467007618 |
| 700783 | ACCESSOIRES | 227 | 3125467007830 |
| 703012 | ACCESSOIRES | 218 | 3125467030128 |
| 703023 | ACCESSOIRES | 218 | 3125467030234 |
| 703034 | ACCESSOIRES | 218 | 3125467030340 |
| 703045 | ACCESSOIRES | 218 | 3125467030456 |
| 703059 | ACCESSOIRES | 218 | 3125467030593 |
| 703060 | ACCESSOIRES | 218 | 3125467030609 |
| 703072 | ACCESSOIRES | 218 | 3125467030722 |
| 703096 | ACCESSOIRES | 219 | 3125467030968 |
| 703107 | ACCESSOIRES | 219 | 3125467031071 |
| 703120 | ACCESSOIRES | 219 | 3125467031200 |
| 703186 | ACCESSOIRES | 219 | 3125467031866 |
| 703325 | ACCESSOIRES | 219 | 3125467033259 |
| 703336 | ACCESSOIRES | 219 | 3125467033365 |
| 705005 | ACCESSOIRES | 220 | 3125467050058 |
| 705027 | ACCESSOIRES | 220 | 3125467050270 |
| 705038 | ACCESSOIRES | 220 | 3125467050386 |
| 705263 | ACCESSOIRES | 222 | 3125467052632 |
| 705274 | ACCESSOIRES | 222 | 3125467052748 |
| 705285 | ACCESSOIRES | 222 | 3125467052854 |

| Ref. | CATALOGUE | PAGE | EAN |
|--------|-------------|------|---------------|
| 705296 | ACCESSOIRES | 222 | 3125467052960 |
| 706426 | ACCESSOIRES | 222 | 3125467064260 |
| 710507 | ACCESSOIRES | 226 | 3125467105079 |
| 710612 | ACCESSOIRES | 222 | 3125467106120 |
| 711616 | SOURCES | 94 | 3125467116167 |
| 711617 | SOURCES | 94 | 3125467116174 |
| 711618 | SOURCES | 94 | 3125467116181 |
| 711619 | SOURCES | 94 | 3125467116198 |
| 711621 | SOURCES | 94 | 3125467116211 |
| 711894 | SOURCES | 78 | 3125467118949 |
| 712069 | ACCESSOIRES | 221 | 3125467120690 |
| 713171 | SOURCES | 95 | 3125467131719 |
| 713172 | SOURCES | 95 | 3125467131726 |
| 713176 | SOURCES | 95 | 3125467131764 |
| 713177 | SOURCES | 95 | 3125467131771 |
| 713178 | SOURCES | 95 | 3125467131788 |
| 713179 | SOURCES | 95 | 3125467131795 |
| 713180 | SOURCES | 95 | 3125467131801 |
| 713196 | SOURCES | 91 | 3125467131962 |
| 713197 | SOURCES | 91 | 3125467131979 |
| 713199 | SOURCES | 93 | 3125467131993 |
| 713200 | SOURCES | 93 | 3125467132006 |
| 713201 | SOURCES | 93 | 3125467132013 |
| 713202 | SOURCES | 91 | 3125467132020 |
| 713209 | SOURCES | 93 | 3125467132099 |
| 713210 | SOURCES | 93 | 3125467132105 |
| 713297 | SOURCES | 93 | 3125467132976 |
| 713400 | SOURCES | 93 | 3125467134000 |
| 713475 | ACCESSOIRES | 224 | 3125467134758 |
| 713488 | ACCESSOIRES | 224 | 3125467134888 |
| 713496 | SOURCES | 91 | 3125467134963 |
| 713497 | SOURCES | 91 | 3125467134970 |
| 713501 | SOURCES | 91 | 3125467135014 |
| 713502 | SOURCES | 91 | 3125467135021 |
| 713503 | SOURCES | 91 | 3125467135038 |
| 713504 | SOURCES | 91 | 3125467135045 |
| 713508 | SOURCES | 91 | 3125467135083 |
| 713511 | SOURCES | 91 | 3125467135113 |
| 713512 | SOURCES | 91 | 3125467135120 |
| 713515 | SOURCES | 91 | 3125467135151 |
| 713517 | ACCESSOIRES | 224 | 3125467135175 |
| 713620 | SOURCES | 92 | 3125467136202 |
| 713622 | SOURCES | 92 | 3125467136226 |
| 713626 | SOURCES | 92 | 3125467136264 |
| 713628 | SOURCES | 92 | 3125467136288 |
| 713771 | SOURCES | 92 | 3125467137711 |
| 713776 | SOURCES | 92 | 3125467137766 |
| 713777 | SOURCES | 92 | 3125467137773 |
| 713778 | SOURCES | 92 | 3125467137780 |

Récapitulatif des références

| Ref. | CATALOGUE | PAGE | EAN |
|--------|-------------|------|---------------|
| 713779 | SOURCES | 92 | 3125467137797 |
| 713780 | SOURCES | 92 | 3125467137803 |
| 714663 | ACCESSOIRES | 224 | 3125467146638 |
| 714696 | ACCESSOIRES | 224 | 3125467146966 |
| 715168 | ACCESSOIRES | 221 | 3125467151687 |
| 715981 | SOURCES | 98 | 3125467159812 |
| 715982 | SOURCES | 98 | 3125467159829 |
| 715984 | SOURCES | 99 | 3125467159843 |
| 715986 | SOURCES | 99 | 3125467159867 |
| 715987 | SOURCES | 99 | 3125467159874 |
| 715988 | SOURCES | 99 | 3125467159881 |
| 715990 | SOURCES | 98 | 3125467159904 |
| 715993 | SOURCES | 98 | 3125467159935 |
| 715994 | SOURCES | 98 | 3125467159942 |
| 715995 | SOURCES | 99 | 3125467159959 |
| 716600 | SOURCES | 99 | 3125467166001 |
| 716601 | SOURCES | 101 | 3125467166018 |
| 716602 | SOURCES | 101 | 3125467166025 |
| 716603 | SOURCES | 103 | 3125467166032 |
| 716604 | SOURCES | 101 | 3125467166049 |
| 716605 | SOURCES | 102 | 3125467166056 |
| 716606 | SOURCES | 102 | 3125467166063 |
| 716607 | SOURCES | 103 | 3125467166070 |
| 716613 | SOURCES | 101 | 3125467166131 |
| 716614 | SOURCES | 102 | 3125467166148 |
| 716615 | SOURCES | 102 | 3125467166155 |
| 716617 | SOURCES | 103 | 3125467166179 |
| 716619 | SOURCES | 101 | 3125467166193 |
| 716621 | SOURCES | 101 | 3125467166216 |
| 716622 | SOURCES | 101 | 3125467166223 |
| 716623 | SOURCES | 79 | 3125467166230 |
| 716624 | SOURCES | 79 | 3125467166247 |
| 716625 | SOURCES | 79 | 3125467166254 |
| 716626 | SOURCES | 79 | 3125467166261 |
| 716627 | SOURCES | 76 | 3125467166278 |
| 716628 | SOURCES | 143 | 3125467166285 |
| 716629 | SOURCES | 143 | 3125467166292 |
| 716630 | SOURCES | 102 | 3125467166308 |
| 716631 | SOURCES | 102 | 3125467166315 |
| 716632 | SOURCES | 102 | 3125467166322 |
| 716633 | SOURCES | 102 | 3125467166339 |
| 716635 | SOURCES | 102 | 3125467166353 |
| 716636 | SOURCES | 102 | 3125467166360 |
| 716642 | SOURCES | 102 | 3125467166421 |
| 716643 | SOURCES | 102 | 3125467166438 |
| 716651 | SOURCES | 94 | 3125467166513 |
| 716653 | SOURCES | 94 | 3125467166537 |
| 716660 | SOURCES | 104 | 3125467166605 |
| 716661 | SOURCES | 104 | 3125467166612 |

| Ref. | CATALOGUE | PAGE | EAN |
|--------|-----------|------|---------------|
| 716662 | SOURCES | 104 | 3125467166629 |
| 716672 | SOURCES | 103 | 3125467166728 |
| 716676 | SOURCES | 101 | 3125467166766 |
| 716678 | SOURCES | 101 | 3125467166780 |
| 716681 | SOURCES | 104 | 3125467166810 |
| 716682 | SOURCES | 104 | 3125467166827 |
| 716683 | SOURCES | 104 | 3125467166834 |
| 716686 | SOURCES | 104 | 3125467166865 |
| 716689 | SOURCES | 104 | 3125467166896 |
| 716690 | SOURCES | 74 | 3125467166902 |
| 716692 | SOURCES | 101 | 3125467166926 |
| 716694 | SOURCES | 101 | 3125467166940 |
| 716695 | SOURCES | 79 | 3125467166957 |
| 716696 | SOURCES | 79 | 3125467166964 |
| 716697 | SOURCES | 79 | 3125467166971 |
| 716698 | SOURCES | 79 | 3125467166988 |
| 716699 | SOURCES | 76 | 3125467166995 |
| 716700 | SOURCES | 76 | 3125467167008 |
| 716703 | SOURCES | 74 | 3125467167039 |
| 716800 | SOURCES | 99 | 3125467168005 |
| 716801 | SOURCES | 99 | 3125467168012 |
| 716802 | SOURCES | 99 | 3125467168029 |
| 716803 | SOURCES | 99 | 3125467168036 |
| 716997 | SOURCES | 120 | 3125467169972 |
| 716998 | SOURCES | 120 | 3125467169989 |
| 716999 | SOURCES | 120 | 3125467169996 |
| 717001 | SOURCES | 84 | 3125467170015 |
| 717002 | SOURCES | 84 | 3125467170022 |
| 717004 | SOURCES | 87 | 3125467170046 |
| 719000 | SOURCES | 109 | 3125467190006 |
| 719001 | SOURCES | 109 | 3125467190013 |
| 719002 | SOURCES | 109 | 3125467190020 |
| 719004 | SOURCES | 110 | 3125467190044 |
| 719005 | SOURCES | 110 | 3125467190051 |
| 719006 | SOURCES | 109 | 3125467190068 |
| 719007 | SOURCES | 109 | 3125467190075 |
| 719008 | SOURCES | 110 | 3125467190082 |
| 719009 | SOURCES | 110 | 3125467190099 |
| 719010 | SOURCES | 110 | 3125467190105 |
| 719011 | SOURCES | 110 | 3125467190112 |
| 719012 | SOURCES | 109 | 3125467190129 |
| 719013 | SOURCES | 110 | 3125467190136 |
| 719014 | SOURCES | 52 | 3125467190143 |
| 719015 | SOURCES | 52 | 3125467190150 |
| 719016 | SOURCES | 51 | 3125467190167 |
| 719017 | SOURCES | 51 | 3125467190174 |
| 719030 | SOURCES | 54 | 3125467190303 |
| 719031 | SOURCES | 54 | 3125467190310 |
| 719032 | SOURCES | 54 | 3125467190327 |

| Ref. | CATALOGUE | PAGE | EAN | |
|--------|-------------|------|---------------|-----|
| 719033 | SOURCES | 54 | 3125467190334 | |
| 719034 | SOURCES | 47 | 3125467190341 | |
| 719035 | SOURCES | 47 | 3125467190358 | |
| 719036 | SOURCES | 48 | 3125467190365 | |
| 719037 | SOURCES | 47 | 3125467190372 | |
| 719038 | SOURCES | 47 | 3125467190389 | |
| 719039 | SOURCES | 52 | 3125467190396 | |
| 719040 | SOURCES | 48 | 3125467190402 | |
| 719041 | SOURCES | 63 | 3125467190419 | |
| 719042 | SOURCES | 141 | 3125467190426 | |
| 719043 | SOURCES | 141 | 3125467190433 | |
| 719044 | SOURCES | 141 | 3125467190440 | |
| 719045 | SOURCES | 67 | 3125467190457 | New |
| 719046 | SOURCES | 67 | 3125467190464 | New |
| 719047 | SOURCES | 67 | 3125467190471 | New |
| 719048 | SOURCES | 67 | 3125467190488 | New |
| 719049 | SOURCES | 46 | 3125467190495 | New |
| 719050 | SOURCES | 46 | 3125467190501 | New |
| 719051 | SOURCES | 43 | 3125467190518 | New |
| 719052 | SOURCES | 43 | 3125467190525 | New |
| 719053 | SOURCES | 55 | 3125467190532 | New |
| 719054 | SOURCES | 55 | 3125467190549 | New |
| 719055 | SOURCES | 55 | 3125467190556 | New |
| 719056 | SOURCES | 55 | 3125467190563 | New |
| 719200 | SOURCES | 51 | 3125467192000 | New |
| 719201 | SOURCES | 51 | 3125467192017 | New |
| 730367 | ACCESSOIRES | 221 | 3125467303673 | |
| 730502 | ACCESSOIRES | 221 | 3125467305028 | |
| 744342 | ACCESSOIRES | 220 | 3125467443423 | |
| 744353 | ACCESSOIRES | 220 | 3125467443539 | |
| 744495 | ACCESSOIRES | 220 | 3125467444956 | |
| 744496 | ACCESSOIRES | 220 | 3125467444963 | |
| 744518 | ACCESSOIRES | 220 | 3125467445182 | |
| 744529 | ACCESSOIRES | 220 | 3125467445298 | |
| 744603 | ACCESSOIRES | 221 | 3125467446035 | |
| 744624 | ACCESSOIRES | 221 | 3125467446240 | |
| 745367 | ACCESSOIRES | 226 | 3125467453675 | |
| 745478 | ACCESSOIRES | 226 | 3125467454788 | |
| 745480 | ACCESSOIRES | 226 | 3125467454801 | |
| 745490 | ACCESSOIRES | 226 | 3125467454900 | |
| 745498 | ACCESSOIRES | 226 | 3125467454986 | |
| 745500 | ACCESSOIRES | 226 | 3125467455006 | |
| 745501 | ACCESSOIRES | 226 | 3125467455013 | |
| 893010 | SOURCES | 165 | 3125468930106 | |
| 893011 | SOURCES | 141 | 3125468930113 | |
| 913020 | SOURCES | 167 | 3125469130208 | |
| 976641 | SOURCES | 48 | 3125469766414 | |
| 976643 | SOURCES | 64 | 3125469766438 | |
| 976644 | SOURCES | 64 | 3125469766445 | |

| Ref. | CATALOGUE | PAGE | EAN |
|--------|-------------|------|---------------|
| 976645 | SOURCES | 64 | 3125469766452 |
| 976646 | SOURCES | 68 | 3125469766469 |
| 976647 | SOURCES | 68 | 3125469766476 |
| 976648 | SOURCES | 64 | 3125469766483 |
| 976652 | SOURCES | 58 | 3125469766520 |
| 976653 | SOURCES | 59 | 3125469766537 |
| 976950 | LUMINAIRES | 176 | 3125469769507 |
| 976951 | LUMINAIRES | 176 | 3125469769514 |
| 976952 | LUMINAIRES | 176 | 3125469769521 |
| 976953 | LUMINAIRES | 176 | 3125469769538 |
| 976971 | ACCESSOIRES | 35 | 3125469769712 |
| 997000 | SOURCES | 137 | 3125469970002 |
| 997001 | SOURCES | 137 | 3125469970019 |
| 997005 | SOURCES | 138 | 3125469970057 |
| 997009 | SOURCES | 138 | 3125469970095 |
| 997108 | SOURCES | 138 | 3125469971085 |
| 998052 | SOURCES | 164 | 3125469980520 |
| 998620 | SOURCES | 159 | 3125469986201 |
| 998622 | SOURCES | 159 | 3125469986225 |
| 998633 | SOURCES | 159 | 3125469986331 |
| 998635 | SOURCES | 162 | 3125469986355 |
| 998638 | SOURCES | 159 | 3125469986386 |
| 998639 | SOURCES | 159 | 3125469986393 |
| 998654 | SOURCES | 159 | 3125469986546 |
| 998655 | SOURCES | 159 | 3125469986553 |
| 998656 | SOURCES | 160 | 3125469986560 |
| 998659 | SOURCES | 160 | 3125469986591 |
| 998662 | SOURCES | 162 | 3125469986621 |
| 998665 | SOURCES | 161 | 3125469986652 |
| 998666 | SOURCES | 161 | 3125469986669 |
| 998667 | SOURCES | 158 | 3125469986676 |
| 998668 | SOURCES | 158 | 3125469986683 |
| 998670 | SOURCES | 160 | 3125469986706 |
| 998671 | SOURCES | 158 | 3125469986713 |
| 998672 | SOURCES | 158 | 3125469986720 |
| 998673 | SOURCES | 163 | 3125469986737 |
| 998674 | SOURCES | 162 | 3125469986744 |
| 998676 | SOURCES | 163 | 3125469986768 |
| 998682 | SOURCES | 158 | 3125469986829 |
| 998683 | SOURCES | 158 | 3125469986836 |
| 998686 | SOURCES | 160 | 3125469986867 |
| 998687 | SOURCES | 160 | 3125469986874 |
| 998695 | SOURCES | 158 | 3125469987017 |
| 998701 | SOURCES | 158 | 3125469987017 |
| 998709 | SOURCES | 159 | 3125469987093 |
| 998710 | SOURCES | 159 | 3125469987109 |
| 998712 | SOURCES | 159 | 3125469987123 |
| 998713 | SOURCES | 159 | 3125469987130 |
| 998750 | SOURCES | 163 | 3125469987505 |

| Ref. | CATALOGUE | PAGE | EAN |
|--------|-----------|------|---------------|
| 998761 | SOURCES | 162 | 3125469987611 |
| 998762 | SOURCES | 162 | 3125469987628 |
| 998763 | SOURCES | 162 | 3125469987635 |
| 998765 | SOURCES | 161 | 3125469987659 |
| 998766 | SOURCES | 161 | 3125469987666 |
| 998767 | SOURCES | 161 | 3125469987673 |
| 998768 | SOURCES | 164 | 3125469987680 |
| 998769 | SOURCES | 164 | 3125469987697 |
| 998770 | SOURCES | 164 | 3125469987703 |
| 999990 | SOURCES | 71 | 3125469999904 |

130 | 1894
ANS | 2024/25

À L'ORIGINE DE LA LUMIÈRE.



GIRARD SUDRON

PARIS 1894

FR 47 rue des Tournelles | 75003 PARIS
+33 (0)1 44 59 22 20 | serviceclients@girard-sudron.com

CH En Courta Rama 2 | 1163 Etoy
+41 (0)22 369 95 00 | info@girard-sudron.ch