



GIRARD SUDRON

PARIS 1894



130 YEARS | 1894 | 2024/25

AT THE ORIGIN OF LIGHT.

ACCESSORIES



GIRARD SUDRON

PARIS 1894



And the light was designed by **GIRARD SUDRON**

*Maison Girard Sudron has been a guest in interiors since 1894.
The brand has spanned the years, the eras, always remaining as innovative as
in its beginnings and reinventing itself to stay in tune with the times.
Its pillars? **Quality, service and passion for light***

130 YEARS OF MODERNITY

Impossible to miss this historic mark. Specialist in high-end and original premium lighting solutions, **Girard Sudron** has always been ahead of its time by initiating trends and integrating the best technologies into products with careful aesthetics. At the beginning of electric lighting, it was the brand that equipped candle chandeliers, by developing a sheath system combined with a luminous candle which made it possible to use this new mode of lighting while retaining a traditional style. The brand then continues to write its history by already establishing itself in the creative sector.

The post-war period saw the revolution of **Girard Sudron** using a new glass blowing technique with a “*slightly curved tip*” which had become iconic. The models still remain relevant today. You won't be the first to succumb!

Girard Sudron lamps light prestigious places such as the Élysée, the Lyon City Hall, the Château de Versailles, the Domaine National de Chambord, the Opéra Garnier, major palaces around the world and luxury businesses.....





Our nerve is our seal

As prestigious as the sapphire present in our LEDs, we amplify the elegance right down to the base of our bulbs, making them luminous both off and on. Anchored in our DNA for so many years, from the Grand Siècle flame to the Edison via our giant 600mm diameter bulb, all our bulbs have a unique golden base. Color of the sun synonymous with signature, our aesthetic does not stop there. From our clear, amber or smokey finishes we pay particular attention to all our bulbs in their entirety.

Why choose LED?

In recent years, sustainable development has become one of the priorities of our contemporary society. This is why we make every effort to produce while protecting nature as well as your consumption. By using our LED lighting, you can significantly reduce your ecological footprint.

Also chosen by the general public for several years, its purchase is more ecological since its lifespan is tenfold compared to an eco-halogen bulb soon to be banned in the European market. Less energy-consuming than an incandescent bulb, it nevertheless has a light intensity of up to 100 lumens per watt.

A brief overview of the advantages of LED

- Bulbs without mercury or polluting gases.
- A lifespan far superior to other light sources.
- Lighting at maximum level from the moment it is switched on and not gradually.
- Less energy-consuming light sources.
- Little need for maintenance due to its longevity.
- No heat release.

BASES

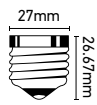

E27

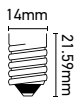

E14

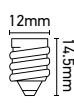

E12

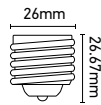

E26

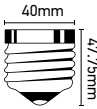

E40

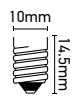

E10



B22

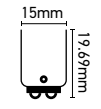

B15



S15



S19



S14S

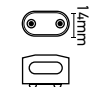

S14D



G9



GU10



GU5.3



GU4

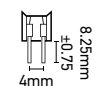

G4



GY6.35



G13



G53



GX53

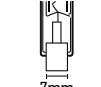

R7S

POWER

Eco-Halogène

LED

Lumens

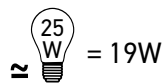

= 19W

=2-3W

=249lm

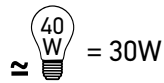

= 30W

=4-5W

=470lm

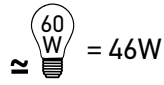

= 46W

=6-9W

=806lm

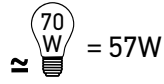

= 57W

=8-12W

=1055lm

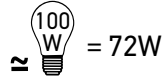

= 72W

=10-15W

=1521lm

SHAPES



CANDLE



SPHERICAL



STANDARD



EDISON

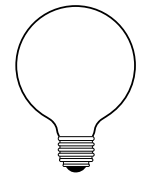

WORLD



TUBE



ZEPELIN

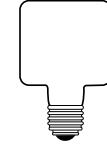

ICE CUBE

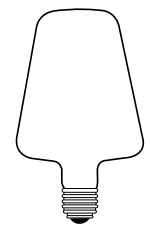

OPERA

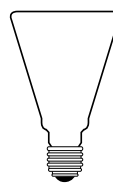

TRIANGLE

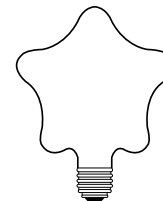

STAR

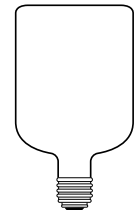

BOTTLE

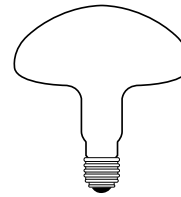

MUSHROOM

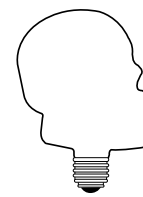

3D SKULL

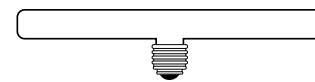

TUBE

COLOR TEMPERATURE

WARM WHITE

Bedrooms,
Living room
Dining room,...

NATURAL
WHITE

Kitchen,
Bathroom

COOL WHITE

Garage, storeroom,
exteriors



SYMBOLS

TENSION

























V. AC
110-240V
50/60Hz

V. AC
220-240V
50/60Hz

V. AC/DC
12V

V. DC
12V

V. DC
24V

Ref.	REFERENCE		CLASS 1
W	POWER		CLASS 2
	BASE		CLASS 3
K	KELVIN		WEIGHT
lm	LUMENS		DRIVER BRAND
mA	CURRENT		INPUT OUTPUT
	NOT USABLE WITH A DIMMER		BAG
	POSSIBLE USE WITH A VARIATOR		PACKAGING
	LIFETIME		FINISH
	INSTANT LIGHTING <1.0 SEC	T°C	OPERATING TEMPERATURE
	BEAM ANGLE	850° 650°	GLOW WIRE TEST
	SWITCHING CYCLE	UGR	GLARE ASSESSMENT
	INGRESS PROTECTION	cULus	CURUS
ENERGY >	ENERGY SCALE		UL
	GUARANTEE Years		BLUETOOTH
Ra	COLOR RENDERING INDEX		SWISS
IK	PROTECTION INDEX AGAINST MECHANICAL SHOCK		CE STANDARD "EUROPEAN CONFORMITY"
PF	POWER FACTOR		ROHS STANDARD "RESTRICTION OF THE USE OF CERTAIN HAZARDOUS SUBSTANCES IN ELECTRICAL AND ELECTRONIC EQUIPMENT"
HG	AMOUNT OF MERCURY		THIS LIGHT FIXTURE IS COMPATIBLE WITH ENERGY CLASS LIGHT SOURCES
	RECESSED		



GIRARD SUDRON

PARIS 1894

Essential to your decoration

Whether you are chandelier restorers wanting to preserve all the quality and choice of materials from yesteryear, or creative with a boundless imagination wanting to adapt to the new consumption of future generations, you will find in this chapter all the lighting accessories you need to re-bring your ideas to life..

From vintage, industrial or design style to raw materials like concrete or noble materials like brass, we offer you a wide choice of items with subtle and elegant finishes to compose all kinds of lighting or restore old unique pieces dear to the eyes of their owners.

In this chapter you will find everything you need to make your light the key element of your decor. As vital as the air we breathe, *customize your suspensions, transform your old kerosene lamps or simply play with recycled objects.*

ACCESSORIES

NEW	12
TABLE LAMPS.....	20
DECORATIVE LAMPSHADE	40
WALL LAMPS	48
DECORATIVE PENDANTS.....	54
DECORATIVE ROSES & CUPS	72
TECHNICAL CEILING CUPS	84
DECORATIVE LAMPHOLDERS.....	88
TECHNICAL LAMPHOLDERS.....	100
DECORATIVE CABLES	128
PRE-ASSEMBLED CABLES.....	142
PLUGS	150
SWITCHES.....	154
DRIVERS	162
SOCKETS AND POWER STRIPS.....	166
CHANDELIER COMPONENTS	172
GLASSWARE & ACCESSORIES	210
CANDLE SLEEVES & CANDLES	228
SUMMARY OF REFERENCES.....	238

NEW





ACCESSORIES

PENDANT LIGHTS E27



241607 | 241608

Cable section | 2 x 0.75mm²
Cable type | H03VV-F
Material
• Ceiling rose | Marble
• Lamp holder | Marble
• Cable | Textile

60W
Max.







CEILING ROSE



CEILING ROSE
300706

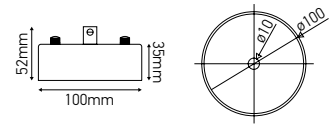

Single outlet
Material: wood



NEW

LAMP HOLDER E27
300630

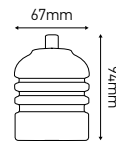

DOUILLE ACIER

LAMP HOLDER E27
WITH SWITCH



300628 | 300629

Material
• Interior | plastic
• Exterior | aluminum

60W
Max.



10





200606 | 200607

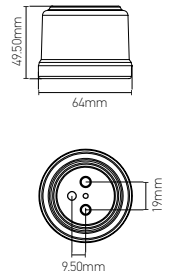

NEW





TABLE LAMPS



LAMP HOLDERS.....	22
WOODEN FLOOR LAMP	27
FLOOR-STANDING LIGHTS	28
TABLE LAMP.....	31



174151 | 174150



V. AC
220-240V
HG = 0.0mg

Ref.	W			Dim. mm	PCB Inner	PCB Outer
174151	40 max.	E27	white	Ø98 x 90 mm	-	9
174150	40 max.	E27	black	Ø98 x 90 mm	-	9



► Light source not included



174152 | 174153 | 174154



V. AC
220-240V
HG = 0.0mg

Ref.	W			Dim. mm	PCB Inner	PCB Outer
174152	40 max.	E27	golden	Ø70 x 96 mm	-	12
174153	40 max.	E27	silver	Ø70 x 96 mm	-	12
174154	40 max.	E27	black	Ø70 x 96 mm	-	12

► Light source not included



174155 | 174156

976663
EDISON amber
E27 | 5W | 2000K | 300lm
Non-dimmable



V. AC
220-240V
HG = 0.0mg

Ref.	W	⚡	💡	Dim. mm	PCB Inner	PCB Outer
174155	40 max.	E27	white	Ø115 x 110 mm	-	9
174156	40 max.	E27	black	Ø115 x 110 mm	-	9

► Light source not included





CE | V. AC
220-240V
50/60Hz

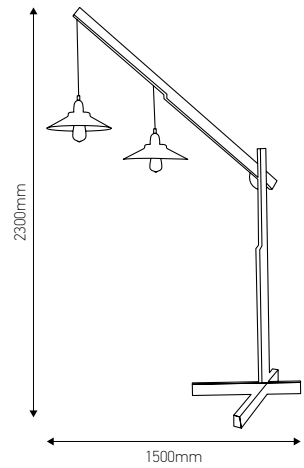

TABLE LAMPS

Ref.	W		Dim. mm	PCB Inner	PCB Outer
300475	2 x 60 max.	E27	2300 x 1500	-	1

► Light source not included

DESKY LED FLOOR LAMP



V. AC
220-240V
50/60Hz

20,000
hours



Ra
≥80

PF
≥0.9

UGR
<21

650°

-20°C
+40°C



158872



Ref.	W	K	lm	mA	LED	★	Kg	Dim. ØxH _{mm}	📦
158872	35	2800-3100	3100	↻ 195mA ↻ 1200mA	100pcs	HONGLI	10.5	Ø280 x 1950	2

► Light sources included





CONCRETE TABLE LAMP E27



V. AC
220-240V
50/60Hz



200800



200802



200801

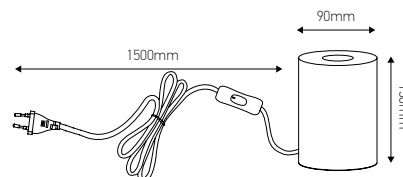
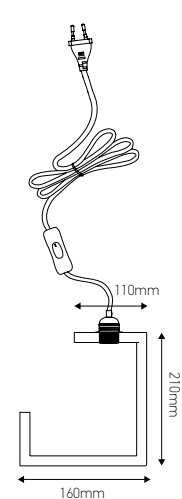
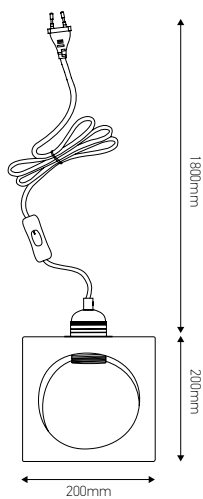

250 x 250 x 160mm



250 x 250 x 160mm

Ref.	W	E27	Cable length	Kg	PCB Inner	PCB Outer
200800	40 max.	E27	1.8m	4.4	1	2
200802	40 max.	E27	1.8m	1.7	1	6
200801	40 max.	E27	1.5m	1.31	1	8

► Light source not included

TABLE LAMPS

WOODEN TABLE LAMP E27



18471

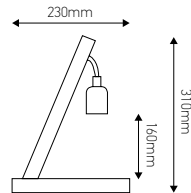

145 x 46 x 305mm

Ref.	W	⚡	Cable length	kg	Dim. mm	PCB Inner	PCB Outer
18471	40W max.	E27	1.8m	0.47	230 x 80 x 310	1	10

Material | Wood + metal

► Light source not included



333003

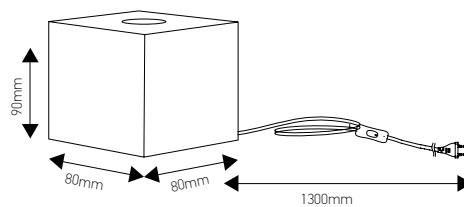

105 x 105 x 145mm

Ref.	W	⚡	Cable length	kg	Dim. mm	PCB Inner	PCB Outer
333003	40W max.	E27	1.3m	0.46	80 x 80 x 90	1	8

► Light source not included





WOODEN TABLE LAMP E27



V. AC
220-240V
50/60Hz



976971

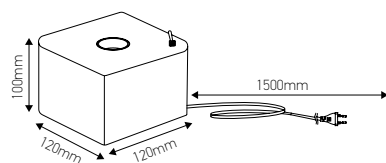

140 x 140 x 145mm

Ref.	W	E27	Cable length	Kg	Dim. mm	PCB Inner	PCB Outer
976971	40W max.	E27	1.5m	0.88	120 x 120 x 100	1	12

► Light source not included

NATURAL BAMBOO TABLE LAMP E27



174130

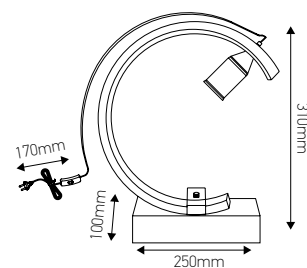
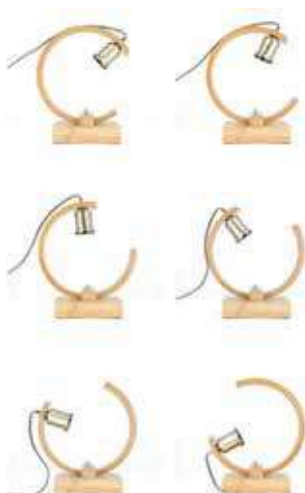

260 x 260 x 100mm

Ref.	W	E27	Cable length	Kg	Dim. mm	PCB Inner	PCB Outer
174130	40W max.	E27	1.7m	0.73	250 x 100 x 310	1	10

► Light source not included

TABLE LAMP E27 WITH SWITCH



V. AC
220-240V
50/60Hz



300456

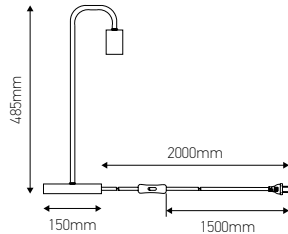

220 x 220 x 420mm

Ref.	W		Cable length	Kg	Dim. mm	PCB Inner	PCB Outer
300456	60W max.	E27	2m	0.8	Ø150 x 485	-	1

► Light source not included

ORI

TABLE LAMP E27 WITH SWITCH AND METAL LAMPSHADE



V. AC
220-240V
50/60Hz



300453



300454

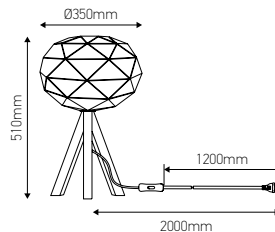

560 x 360 x 350mm

Ref.	W		Cable length	Kg	Dim. mm	PCB Inner	PCB Outer
300453	60W max.	E27	2m	2.3	Ø350	-	1
300454	60W max.	E27	2m	2.3	Ø350	-	1

► Light source not included



WOODEN TABLE / HANGING LAMP E27

V. AC
220-240V
50/60Hz

25000H

360°

Ra
≥80

OFF ON
≥15,000

100% 0 sec

-20°C
+40°C

3 ans

GROUP 0
EN62471:2008



333000

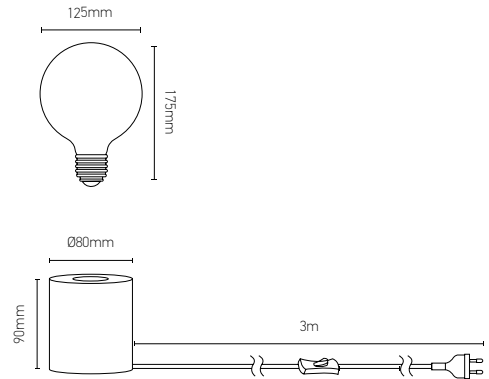
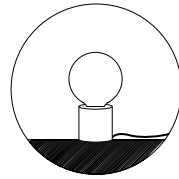
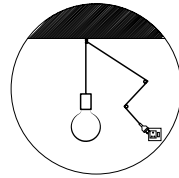

Ref.	W		K	lm	mA	Kg	Cable length	
333000	5	E27	2000	260	43	0.58	3m	8

► Sold with bulb (ref. 716602)







DECORATIVE LAMP SHADE

CONICAL METAL	42
FLARED METAL	42
INDUSTRIAL METAL	42
METAL DISCS.....	45
METAL CAGE.....	46





300800



300802

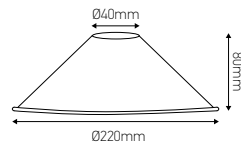

300803



300804



225 x 225 x 85mm



300903

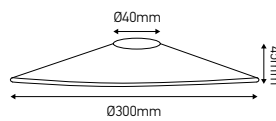

305 x 40 x 305mm

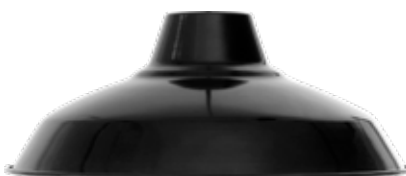

301001

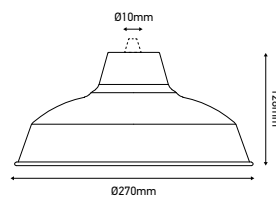

275 x 275 x 135mm



187597



187596

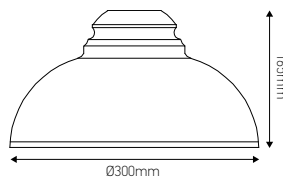

305 x 305 x 170mm

► For use with lampholder with ring



187589

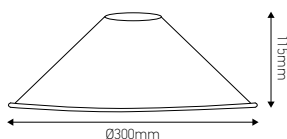

305 x 305 x 120mm

► For use with lampholder with ring



187588

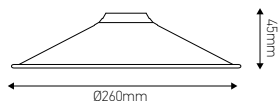

265 x 55 x 265mm

► For use with lampholder with ring

DECORATIVE LAMPSHADE

SCREWABLE DISCS.
PLAY THE CONTRAST WITH
THESE REVERSIBLE DISCS.





187586
white and black



187584
copper and black



305 x 50 x 305mm

Small disc | Ø220 x 2mm
Large disc | Ø300 x 3.5mm
For use with lampholder with ring

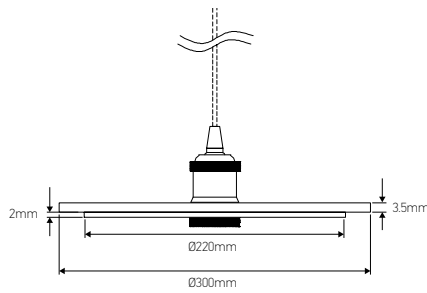

300503



300504

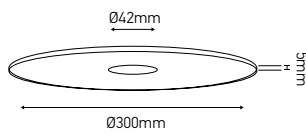

310 x 18 x 310mm

Disc | Ø300 x 5mm
For use with lampholder with ring



305001



305002

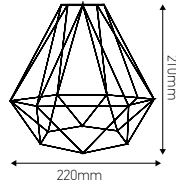

230 x 230 x 210mm

Ref.	Color	Material	ØxH _{mm}
305001	black	metal	220 x 210
305002	copper	metal	220 x 210







WALL LAMPS

WALL LAMP G9	50
WALL LAMP E27	51

60W
Max.

V. AC
220-240V
50/60Hz



300250



300251

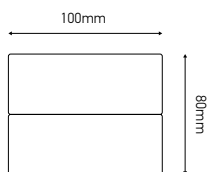

105 x 105 x 90mm

► G9 bulb not included



► Light source not included

60W
Max.



300200

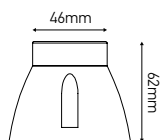

80 x 80 x 70mm



300210



300211

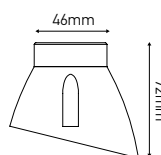

80 x 80 x 70mm



300220



300221

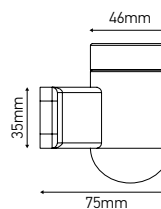

85 x 85 x 85mm



► Light source not included



► Light source not included



EN 60598-2-1 | 1989
 used in conjunction with
 EN 60598-1 | 2015
 EN 62031 | 2008+A1 | 2013+A2 | 2015
 EN 62471 | 2008



167513



167512

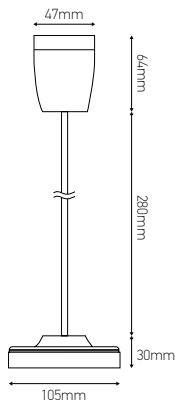

Ø110 x 180mm

Flexible tube
 Cable section | 2 x 0.75mm²
 Cable type | H05V-K



167511



167510

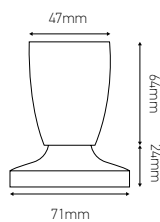

72 x 72 x 87mm

Cable section | 2 x 0.75mm²
 Cable type | H05V-K



► Light source not included



DECORATIVE PENDANTS



MARBLE PENDANT LIGHTS NEW	57
PORCELAIN PENDANT LIGHTS.....	57
CONCRETE PENDANT LIGHTS.....	58
METAL PENDANT LIGHTS.....	58
SILICONE PENDANT LIGHTS.....	66
PLASTIC PENDANT LIGHTS.....	66
NATURAL HEMP PENDANT LIGHTS	69



60W
Max.



241607



241608

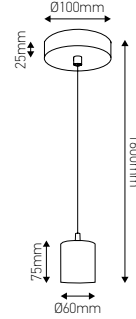

NEW

Cable section | 2 x 0.75mm²
Cable type | H03VV-F
Material
• Ceiling rose | Marble
• Lamp holder | Marble
• Cable | Textile

PORCELAIN PENDANT LIGHT E27 L.1000 / 2000mm



60W
Max.



167518



167519

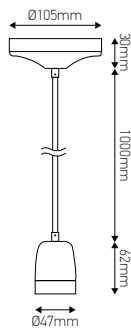

187562

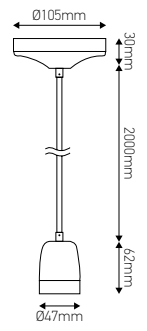

Cable section | 2 x 0.75mm²
Cable type | H03VV-F
Material
• Ceiling rose | Porcelain
• Lamp holder | Porcelain
• Cable | Textile



Ø110 x 100mm

DECORATIVE PENDANT LIGHTS

CONCRETE PENDANT LIGHT E27 L.2000mm



187557

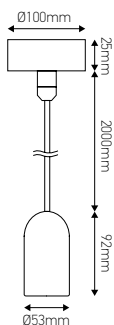

Cable section | 2 x 0.75mm²
Cable type | H03VV-F
Material
• Ceiling rose | Steel
• Lamp holder | Concrete
• Cable | Textile



Ø110 x 125mm

METAL PENDANT LIGHT E27 L.1000mm



241606

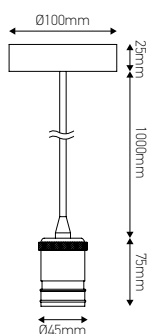

Cable section | 2 x 0.75mm²
Cable type | H03VV-F
Material
• Ceiling rose | Steel
• Lamp holder cover | Aluminum
• Lamp holder | Plastic
• Cable | Textile



Ø110 x 100mm



METAL PENDANT LIGHT E27 L.2000mm



187516



187517

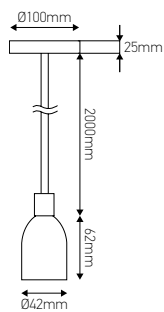

- Cable section | 2 x 0.75mm²
 Cable type | H03VV-F
 Material
 • Ceiling rose | Steel
 • Lamp holder cover | Aluminum
 • Lamp holder | Plastic
 • Cable | Textile



Ø110 x 100mm

METAL PENDANT LIGHT E40 L.2000mm



187515



200900



200901

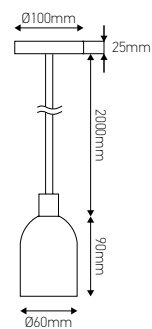

- Cable section | 2 x 0.75mm²
 Cable type | H03VV-F
 Material
 • Ceiling rose | Steel
 • Lamp holder cover | Aluminum
 • Lamp holder | Ceramic
 • Cable | Textile



Ø110 x 150mm



METAL PENDANT WITH THREADED LAMP HOLDER E27 AND CLAMPING RING L.2000mm



187585

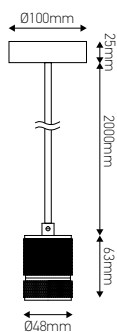

Cable section | 2 x 0.75mm²

Cable type | H03VV-F

Material

- Ceiling rose | Steel
- Lamp holder cover | Aluminum
- Lamp holder | Plastic
- Cable | Textile

Utilization

Can be used with a lampshade or glassware



Ø110 x 125mm

METAL PENDANT LIGHT WITH E27 L.1000 RING



300410

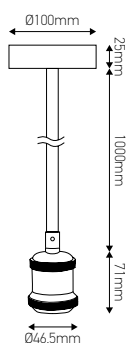

Cable section | 2 x 0.75mm²

Cable type | H03VV-F

Material

- Ceiling rose | Steel
- Lamp holder cover | Aluminum
- Lamp holder | Plastic
- Cable | Textile

Utilization

Can be used with a lampshade or glassware



Ø110 x 100mm

METAL PENDANT WITH THREADED LAMP HOLDER E27 AND RING L.1000mm



241604

241605

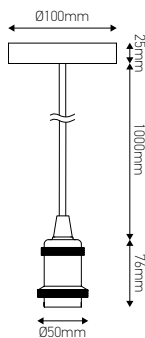

Cable section | 2 x 0.75mm²
 Cable type | H03VV-F
 Material
 • Ceiling rose | Steel
 • Lamp holder cover | Aluminum
 • Lamp holder | Plastic
 • Cable | Textile

Utilization
 Can be used with a lampshade or glassware



Ø110 x 100mm

METAL PENDANT WITH THREADED CYLINDER LAMP HOLDER E27 AND RING L.2000mm



187563

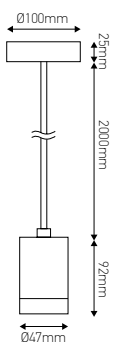

Cable section | 2 x 0.75mm²
 Cable type | H03VV-F
 Material
 • Ceiling rose | Steel
 • Lamp holder cover | Aluminum
 • Lamp holder | Plastic
 • Cable | Textile

Utilization
 Can be used with a lampshade or glassware



Ø110 x 125mm



40W
Max.



12



174162



174160



174161

Color | black / gold / copper
Material | brass
Cable length | 1.35m

*Light source not included

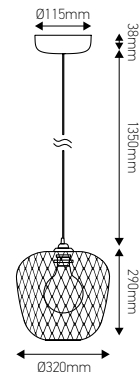



► Light source not included

SILICONE PENDANT LIGHT E27 L.800mm



241879



241880

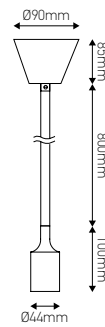

Ø110 x 125mm

Cable section | 2 x 0.75mm²
 Cable type | H05SS-F
 Material
 • Ceiling cup | Polypropylene
 • Lamp holder cover | Silicone
 • Lamp holder | Plastic
 • Cable | silicon

PLASTIC PENDANT LIGHT E27 WITH RING AND NYLON CABLE (L. 0.6m)

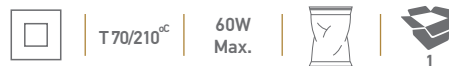

EN 60598-1 2015



241851



241853

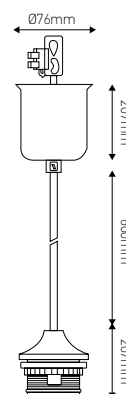

241857

Ref.	E27	Lightbulb icon	Material	Cable type	Cable section
241851	E27	black	polypropylene	H03V2V2F-F	2 x 0.75mm ²
241853	E27	white	polypropylene	H03V2V2F-F	2 x 0.75mm ²
241857	E27	gold	polypropylene	H03V2V2F-F	2 x 0.75mm ²

Suspension clevis with clamp and 4mm² connection strip - 2 studs
 Ceiling cup with ring and locking screw
 Nylon cable clamp
 Maximum weight of lampshade 1kg - Hole Ø40mm



241879
Silicone suspension

► Light source not included



200700
Hemp rope

976647
ZAVONA E27

V. AC
220-240V
50/60Hz



40W
Max.

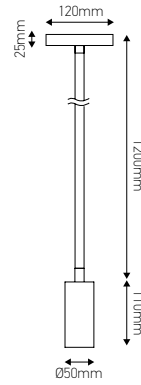

200700

Cable section | 2 x 0.75mm²
Cable type | H03VV-F



265 x 265 x 340mm

TWISTED HEMP CABLE 2 x 0.75mm²



60W
Max.



187599

With E27 Lamp holder
Ø25mm
Cable type | H03VV-F

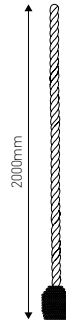

150 x 150 x 150mm



187599
Twisted Hemp
Cable

716602
Globe twisted



DECO CEILING ROSES

WOODEN CEILING ROSE NEW	74
PORCELAIN CEILING ROSE.....	74
CEILING ROSE SINGLE OUTLET	76
CEILING ROSE 3 OR 6 OUTLETS.....	78
CEILING ROSE 5 OUTLETS.....	80
RECTANGLE STEEL CEILING ROSE	82
METAL HOOK FOR FIXING	83

WOODEN CEILING ROSE SINGLE OUTLET Ø100mm



300706

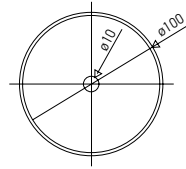
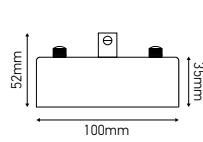

NEW

Single outlet
Material: wood

PORCELAINE PORCELAIN CEILING ROSE WITH CABLE STOP Ø105 / Ø68mm



187518



187519



187520



187521

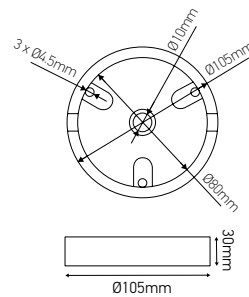

105 x 35 x 105mm



300300



300301

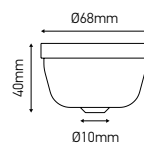

70 x 56mm

Sold with mounting kit and fixing bar.
Matching cable clamp, domino, nuts.
Maximum cable Ø | 7mm





187572



187573

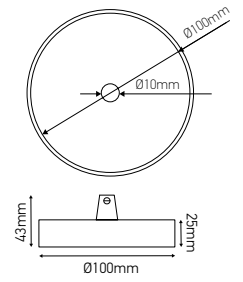

187522



187523



187524



105 x 35 x 105mm



300352



300351



300353



300354



300356



300357



300702



300703



300704



300705

Sold with mounting kit and fixing bar, matching cable clamp, domino, nuts. max cable Ø | 7mm





187525



187526



187527



187528

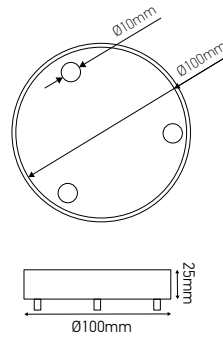

105 x 35 x 105mm

Sold with mounting kit and fixing bar,
Matching cable clamp, domino, nuts.
Maximum cable Ø | 7mm

STEEL CEILING ROSE Ø100mm 6 OUTLETS WITH CABLE STOP



187529

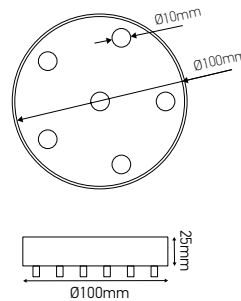

105 x 35 x 105mm

Sold with mounting kit and fixing bar, matching
cable clamp, domino, nuts.
Maximum cable Ø | 7mm





187574



187575



187576



187577



187578

Sold with mounting kit and fixing bar.
Matching cable clamp, domino, nuts.
Maximum cable Ø | 7mm

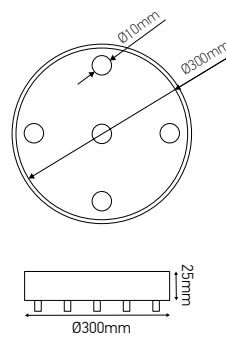

310 x 30 x 310mm





187613
Rectangular ceiling rose

189640
Round textile cable

187564
Black aluminum Lamp holder

LICA RECTANGLE STEEL CEILING ROSE 300mm



187610
2 outputs

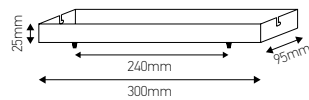

LICA RECTANGLE STEEL CEILING ROSE 470mm



187612
3 outputs



187613
3 outputs

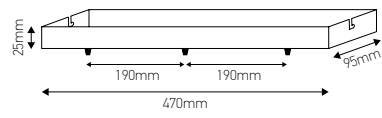

LICA RECTANGLE STEEL CEILING ROSE 900mm



187614
4 outputs



187615
4 outputs

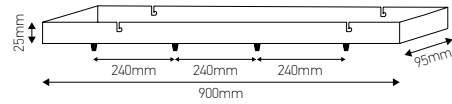

187616
7 outputs



187617
7 outputs

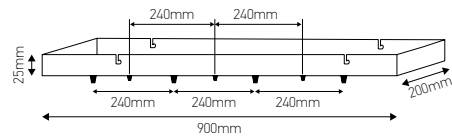

DECO CEILING ROSE

STEELY METAL HOOK CABLE STOP WITH FIXING SCREW



310001
(3pcs)
50 x 50 x 50mm



310002
(5pcs)
50 x 50 x 50mm



310004
(3pcs)
50 x 50 x 50mm



310005
(5pcs)
50 x 50 x 50mm

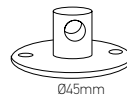
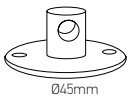



TECHNICAL CEILING CUPS



POLYPROPYLENE CEILING CUP.....	86
BRASS AND STEEL CEILING CUP.....	87

POLYPROPYLENE CEILING CUP

EN 60598-1 2008 A1 2009



60W
Max.



241975



241974

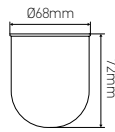

241983

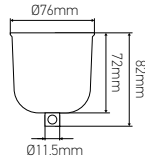

241962

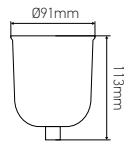

Ref.	Material	Description	Ømm
241975	polypropylene	truncated conical roof	Ø68 x 72
241974	polypropylene	truncated conical roof	Ø68 x 72
241983	polypropylene	cylindrical bell with stop screw	Ø76 x 82
241962	polypropylene	to screw on the rise and fall	Ø91 x 113

POLYPROPYLENE CONICAL BELL CEILING CUP WITH STOP SCREW



241993

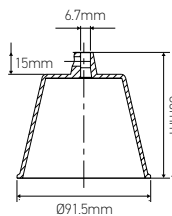

Ref.	Material	Ømm
241993	polypropylene	Ø91.5 x 86

BRASS AND STEEL CEILING CUP



282852

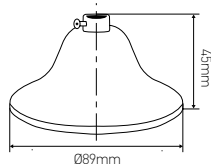

282963

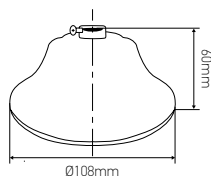

Ref.	Material	For tube	Dim. ØxH _{mm}
282852	varnished brushed brass	Ø10mm	Ø89 x 45mm
282963	steel	Ø10mm	Ø108 x 60mm

TECHNICAL PAVILIONS



283884



283895

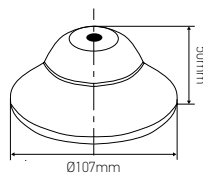

Ref.	Material	Hole Ø _{mm}	Dim. ØxH _{mm}
283884	chrome-plated brass	11	Ø107 x 50
283895	varnished polished brass	11	Ø107 x 50



DECORATIVE LAMP HOLDERS

STEEL E27 NEW	90
WOOD E27 NEW	90
PORCELAIN E27	92
CONCRETE E27	95
ALUMINUM E27	95
COPPER E27	97
METALLIC E27	97
BAKELITE E27	99

STEEL LAMP HOLDER E27 WITH SWITCH + RING

60W
Max.



300628



300629

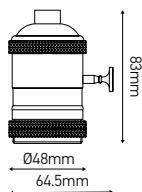

NEW

Material

- Interior | plastic
- Exterior | aluminum

WOODEN LAMP HOLDER E27



300630

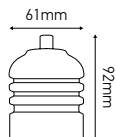

NEW

Material

- Interior | plastic
- Exterior | wooden





158063



187540



187541



187554

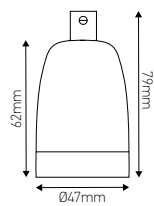

48 x 48 x 80mm



187542

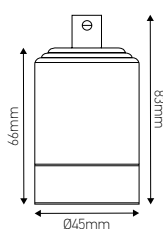

48 x 48 x 80mm

CERAMIC LAMP HOLDER E14



300101



300102

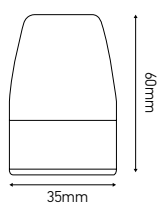

50 x 50 x 75mm







300611



300612



300613



300614



300616

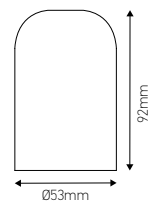

48 x 48 x 95mm



300621



300622



300623



300624



300626



300627

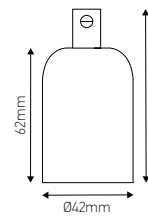

48 x 48 x 80mm



187547



187548



187549

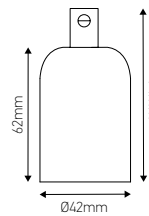

48 x 48 x 80mm



187552

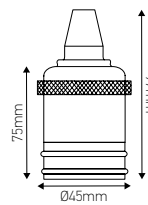

48 x 48 x 80mm



187564

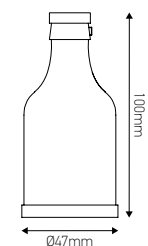

48 x 48 x 105mm



187568



187569



187570

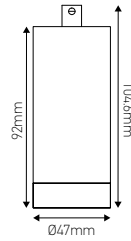

48 x 48 x 105mm



300600



300601



300602



300604

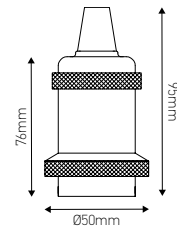

48 x 48 x 80mm



187571

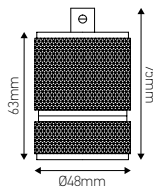

48 x 48 x 80mm

THREADED STEEL LAMP HOLDER E27

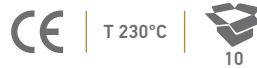

187546
Ø40 x 72mm

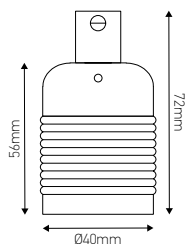

48 x 48 x 80mm

THREADED ALUMINUM LAMP HOLDER E27 WITH RING



187543



187544

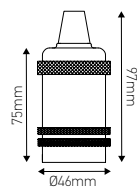

48 x 48 x 80mm



187550



187551

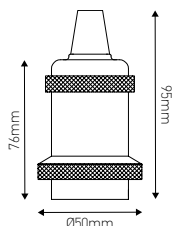

48 x 48 x 80mm

THREADED COPPER LAMP HOLDER E27 WITH RING



187553

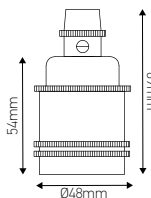

48 x 48 x 80mm

THREADED METAL LAMP HOLDER E27 WITH RING

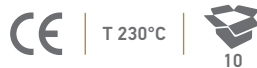

EN60238 2004 A1
2008 A2 2016



220883
Ø60 x 59mm



220884
Ø60 x 59mm





THREADED METAL LAMP HOLDER E14 WITH RING



T 230°C



EN60238 2004 A1
2008 A2 2011



210883
Ø42.5 x 66mm



210884
Ø42.5 x 66mm

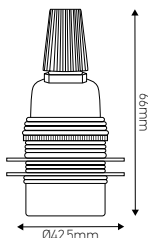

BAKELITE LAMP HOLDER E27



T 165°C



EN60238 2004 A1
2008 A2 2015



219331
with switch
Ø39 x 97mm

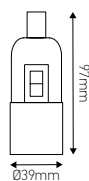



TECHNICAL LAMP HOLDERS

LAMP HOLDERS E27	102
LAMP HOLDERS E14	106
LAMP HOLDERS E12	109
LAMP HOLDERS E26	110
METAL LAMP HOLDERS E27/E14	112
CLAMPING RINGS.....	113
LAMP HOLDERS S14D / S14S.....	114
RING REDUCERS.....	114
LAMP HOLDERS B22 / B15.....	116
SPECIFIC LAMP HOLDERS.....	118
LAMP HOLDER ADAPTERS.....	126

ASSEMBLED LAMP HOLDER E27



EN60238

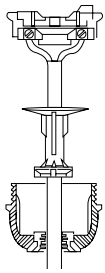

Thermoplastic



Screw terminal insertion
Use an isostop ref. 231627



Metal fitting base 10 x 1 with retainer and stop screw

SMOOTH OUTER SHELL Ø39mm



216351



216353



216357

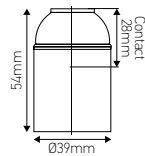

THREADED OUTER SHELL Ø40



216551



216553



216557

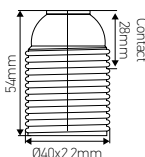

HALF-THREADED OUTER SHELL WITH HOLDER Ø46mm



216651



216653



216657

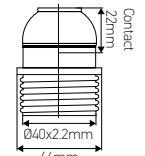

HALF-THREADED OUTER SHELL WITH HOLDER



216451



216457

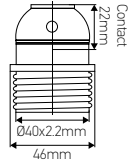

With side exit and reach

SMOOTH OUTER SHELL WITH EARTH Ø39mm



216251

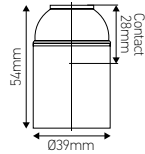

HALF-THREADED OUTER SHELL WITH EARTH & HOLDER Ø40mm



216751

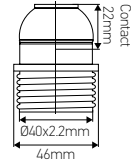

HALF-THREADED OUTER SHELL WITH HOLDER & AUTOMATIC SOCKET Ø40mm

EN60238



216171

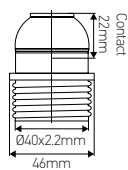

THREADED OUTER SHELL Ø40mm



216091

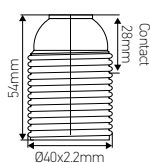

ASSEMBLED LAMP HOLDER 27 WITH SWITCH AND HOLDER



219351



219323

Lamp holder with switch, metal fitting 10 x 1,
Ø40mm threaded sleeve with stop screw and switch



ASSEMBLED LAMP HOLDER E14



EN 60238
EN60238 2004 | A1 2008 | A2 2019

Thermosetting insulation
Thermoplastic
Use an isostop ref. 231614
Delivered assembled with terminal upside down
Screw terminal insertion

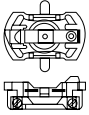

The Lamp holders, base height 16mm, allow class II equipment if they are assembled on a plastic support. Class I equipment assembled on a metal connection connected to earth.
10 x 1 metal fitting base with retainer, stop screw and earth terminal

SMOOTH OUTER SHELL, SHORT BASE Ø27mm H15



213051



213053



213057

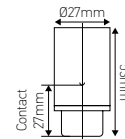

THREADED OUTER SHELL, SHORT BASE Ø28mm



213151



213153



213157

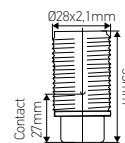

HALF-THREADED OUTER SHELL WITH HOLDER, SHORT BASE Ø28mm



213291



213293



213297

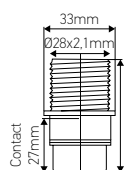

SMOOTH OUTER SHELL Ø27mm H21 BASE



213501

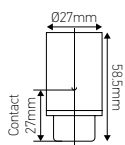

NON-ASSEMBLED LAMP HOLDER E14

EN60238



Thermosetting insulation
Use an isostop ref. 231627



10 x 1 connection base and stop screw
Base height 16mm, cable passage Ø5.5mm

Lamp holder, base height 16mm. Use with isostop ref. 231734 specific for base with lateral cable passage for class II table lamp. Class I chandelier assembly, cable outlet on chandelier arms.
Warning | the use of the 16mm base with isostop for lateral cable passage does not allow the assembly to comply with the distances in the air.

SMOOTH OUTER SHELL E14 Ø27mm



213361



213363

AUTOMATIC TRANSPARENT LAMP HOLDER E14

EN60238



214514
Smooth outer shell
Ø26.5 x 58mm



214534
Threaded outer shell
Ø26.5 x 58mm

Material | Thermoplastic

Spring terminals for rigid or flexible cables from 0.5 ÷ 1.5mm²

Connection | through holes for 3mm self-threading screws or with snap-on domes

With M10 x 1 threaded connection, with retainer and set screw

NON-ASSEMBLED LAMP HOLDER E14



EN60238

Thermoplastic insulation

Use an isostop ref. 231627

Cable stripping | 7mm - conductor section 0.5 to 1.5mm² - flexible or rigid cable

Removable automatic terminals, clip-on base 10 x 1

Lamp holder, high base. 21.5mm for equipping class II luminaires. The interior volume of the base allows the insertion of an isostop ref. 231614

High base. 21.5mm tapped 10 x 1 set screw

SMOOTH OUTER SHELL E14 Ø26mm



214513

HALF-THREADED OUTER SHELL WITH HOLDER E14 Ø28mm



214563

HALF-THREADED OUTER SHELL WITH HOLDER E12 Ø34mm



215273

Thermoplastic
Unassembled | 3 separate elements
Note | for reasons of standardization,
these elements are not marketed separately

NON-ASSEMBLED THERMOPLASTIC LAMP HOLDER E26 USA

T 150°C



Thermoplastic
Unassembled | 3 separate elements
Note | for standardization reasons, these elements are not sold separately

HALF-THREADED OUTER SHELL WITH HOLDER E26 Ø46mm



221681
Ø46 x 51.5mm

NON-ASSEMBLED LAMP HOLDER E12 WITH THREADED OUTER SHELL



215163
Thermosetting insulating Lamp holders



216173

SMOOTH BRASS STEEL LAMP HOLDER E27



220960
brass-plated steel

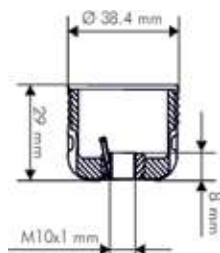

Lamp holder, metal connection 10 x 1, stop screw use with earthing terminal on the luminaire



ASSEMBLED LAMPHOLDER E27 / E14

T 230°C



EN60238

Material | Steel
With blocking device and earth terminal
Metal connection 10 x 1, stop screw
Screw terminals
Cable to use | 0,5 to 2,5mm²
Delivered assembled with terminal upside down

THREADED OUTER SHELL WITH EARTH E27 Ø38mm

4A
250V



220879
Ø38 x 64mm



220889
Ø38 x 64mm



220888
Ø38 x 64mm



220881
Ø38 x 64mm

THREADED OUTER SHELL WITH EARTH E14

2A
250V



210879
Ø25 x 62mm



210889
Ø25 x 62mm



210888
Ø25 x 62mm

Terminal | screw for rigid or flexible cable 0,5 ÷ 2,5mm²

THREADED LAMP HOLDER WITH INSULATOR E27 Ø38mm



220969

White zinc plated
Metal connection 10 x 1, stop screw
Screw terminals
Cable to use | 0,5 to 2,5mm²
Delivered assembled with terminal upside down
(Ø x H) | Ø38 x 64mm

RING FOR LAMP HOLDER E27

T 230°C |  10



Ref.		Material	Dim. ØxH _{mm}
220979	E27	steel	Ø60 x 15.5mm
220989	E27	steel	Ø60 x 15.5mm
220988	E27	steel	Ø60 x 15.5mm
220981	E27	steel	Ø60 x 15.5mm
218421	E27	thermoplastic	Ø57 x 12mm
218423	E27	thermoplastic	Ø57 x 12mm

Ref.		Material	Dim. ØxH _{mm}
218427	E27	thermoplastic	Ø57 x 12mm
218433	E27	thermoplastic	Ø57 x 12mm
218401	E27	thermoplastic	Ø47 x 9mm
218403	E27	thermoplastic	Ø47 x 9mm
218407	E27	thermoplastic	Ø47 x 9mm

RING FOR LAMP HOLDER E14

T 230°C |  10



Ref.		Material	Dim. ØxH _{mm}
210979	E14	steel	Ø42.5 x 11mm
210989	E14	steel	Ø42.5 x 11mm
210988	E14	steel	Ø42.5 x 11mm
214451	E14	thermoplastic	Ø43 x 9.5mm
214453	E14	thermoplastic	Ø43 x 9.5mm

Ref.		Material	Dim. ØxH _{mm}
214457	E14	thermoplastic	Ø43 x 9.5mm
214444	E14	thermoplastic	Ø43 x 9.5mm
214421	E14	thermoplastic	Ø35 x 7mm
214423	E14	thermoplastic	Ø35 x 7mm
214427	E14	thermoplastic	Ø35 x 7mm

LAMP HOLDER FOR S14D / S14S LAMP

250V
1A

T 200°C



IEC 60838-2-1



210596



210598

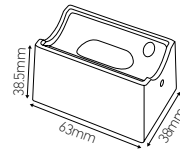

210597



210599

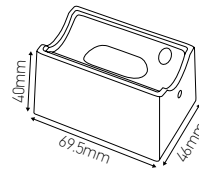

Ref.	Material	
210596	white plastic	S14Dx1
210597	chrome-plated metal	S14Dx1
210598	white plastic	S14S x 2
210599	chrome-plated metal	S14S x 2

S14S sold in pairs

RING REDUCERS E27 / E14 - B22



233353



233367

Ref.	Material	Ø mm
233353	nylon	Ø44
233367	nylon	Ø44



FRENCH THREAD LAMP HOLDER B22 WITH RING



210206

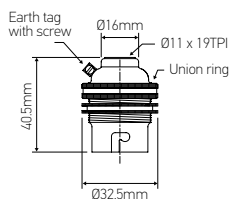

210215
with side hole

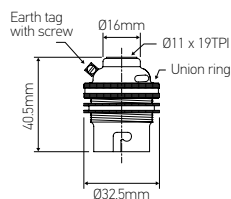

INTERNATIONAL THREAD



210221

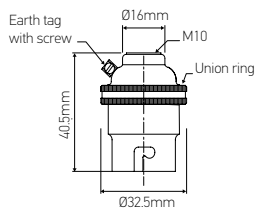

210226
With ring

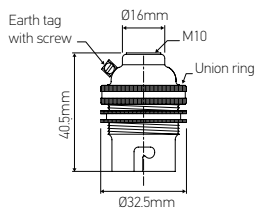

210229
With side hole and double ring

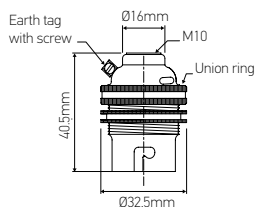

142693
international thread (with & without bec)

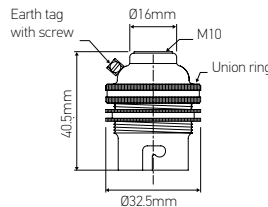

INTERNATIONAL THREAD WITH PUSHBAR SWITCH (BC)



EN 61184



210258

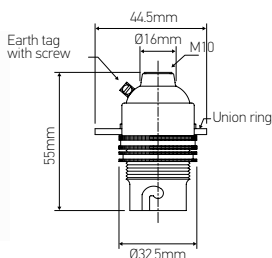

BRASS BAYONET CAP LAMPHOLDER B22 WITH HOOK (BC)



NF - EN 61184



210247

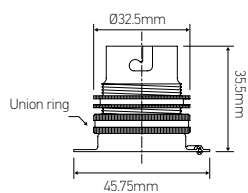

Ø45mm hook with earth terminal
Brass

BRASS BAYONET CAP LAMPHOLDER B15 (SBC)



EN 61184



210298

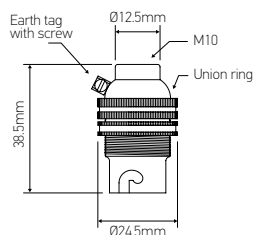

International brass bayonet Lamp holder with double ring
10 x 1 female connection. Stop screw and earth terminal

PLIER FOR B15 & B22 LAMPHOLDER



210385

Material | Aluminum

LAMP HOLDER GU10

2A
250V

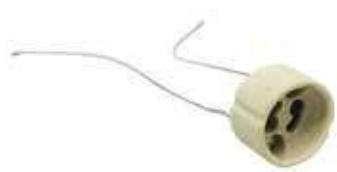

262171

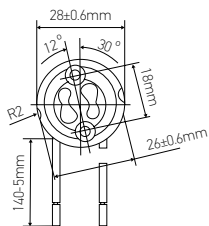

262185

Porcelain
For low voltage halogen lamps
Vertical cable outlet
PTFE cable 0.75
L: 150mm - crimped ends Ø28mm

PET 180°C
Threaded cap 10 x 1
For class II mounting Ø30mm

LAMP HOLDER GU10 WITH HOLDER

CE



262180

Silicone cable holder | 15cm
Not compatible with stamped metal hubcaps

SELF-TAPPING SCREW FOR GU10

100/1000



262100

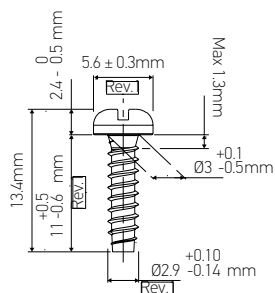

G9 AND LED LAMP HOLDER

2A
250V | T 280°C



269147



269146

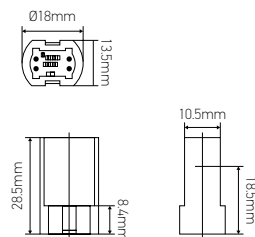

Steatite
Ø18mm
Compatible with extension 269324

STEEL CAP 10 x 100 CLIP-ON FOR LAMP HOLDER G9



269148



269150

TECHNICAL SOCKETS

CLIP-ON EXTENSION FOR G9

EN 60838-1



269324

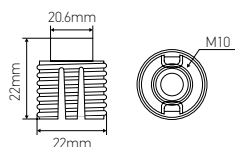

PPS extension M10 x 1 thread
For low voltage halogen lamps
Height | 21.1mm

BEIGE RING FOR LCP LAMP HOLDER G9

T 250°C

0.5A
250V



EN 60838 -1



269168

SCREW FOR TBT LAMP HOLDER



157163
Ø3 x 11mm

Finishing | Zinc plated

PPS SLEEVE FOR FEMALE TBT LAMP HOLDER 10x1

T 220°C



100/1000



262049

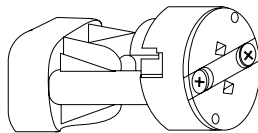

Ø17 x 12.1mm

HOOK LAMP HOLDER 12V



100



210571
Coat hook E14 - D 38mm

DE black insulating material
Exclusive use 12 Volts

LAMP HOLDER FOR TBT HALOGEN SOURCES

10A
12V

T 300°C



262048

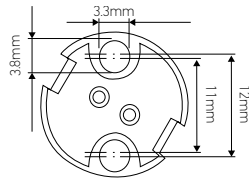
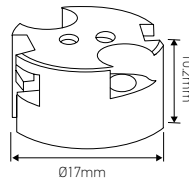

Nickel-plated brass contacts 17 x 11mm
Fixing distance 11mm, holes Ø3.3mm
Teflon cable | 1 x 0.75mm² - T 200°C - L.1m
High temperature protection

LAMP HOLDER G5 FOR TBT HALOGEN SOURCES



10A
12V

T 120°C



262046

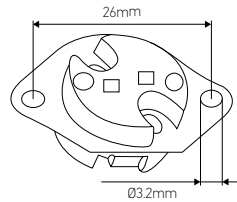

Nickel-plated brass contacts 17 x 11mm
Silicone cables 1 x 0.75mm² - T 180°C - 1.50m
Ø26mm
High temperature protection

LAMP HOLDER G4 FOR TBT HALOGEN SOURCES

6A
12V

T 180°C



262015

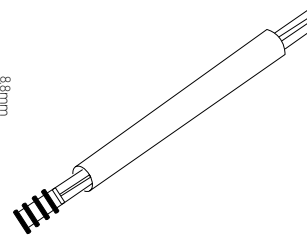
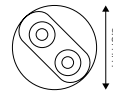
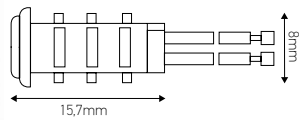

Nickel-plated bronze contacts
Silicone cable | 1 x 0.75mm²
Length 150mm for tube
Int. diameter: 7.8 ± 0.10mm

PORCELAIN LAMP HOLDER E27

4A
250V | T 180°C



153373

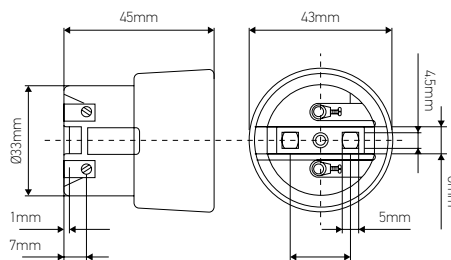

Screw terminals for rigid or flexible cable 0.5 ÷ 2.5mm²
Screwed shell | Galvanized steel

CONICAL PORCELAIN LAMP HOLDER E27

4A
250V | T 210°C



221123

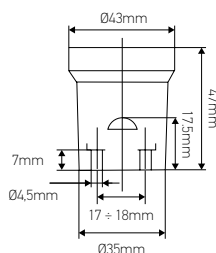

Nickel-plated brass contacts
Rear fixing by screw

PORCELAIN LAMP HOLDER E27/E40 WITH MOUNTING BRACKET AND EARTH TERMINAL

4A
250V | T 210°C



16A
500V | T 210°C



221246
E27

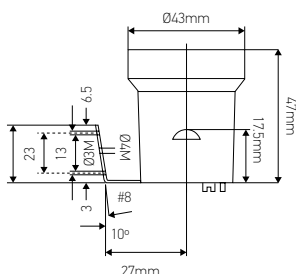

221860
E40

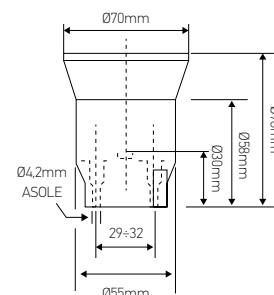

Nickel-plated brass contacts
Mounting bracket with earth terminal

PORCELAIN LAMP HOLDER E27 WITH SCREWED ADAPTOR

4A | T210°C | 2000



221343

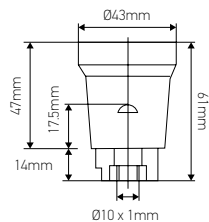

10x1 metal connector, stop screw and ground terminal
Nickel-plated brass contacts

PORCELAIN LAMP HOLDER E14 WITH SCREWED ADAPTOR

2A | T 210°C | 1000



221014

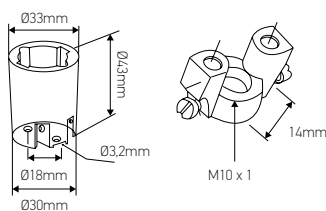

10 x 1 metal connector, stop screw and ground terminal
Nickel-plated brass contacts

CERAMIC LAMP HOLDER R7S

8A | T 250°C | 250



260050

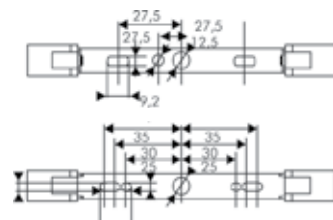
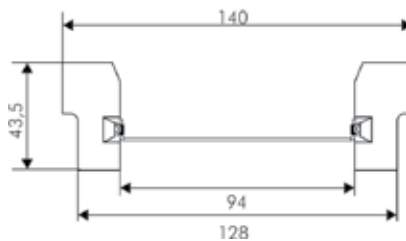

Lamp holder with treated steel bracket
140 x 14 x 43mm, fixing distance 60mm

LAMP HOLDER WITH R7S BRACKET

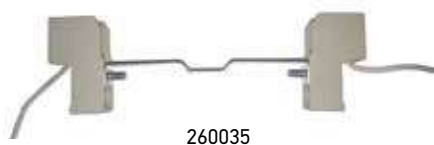

260035

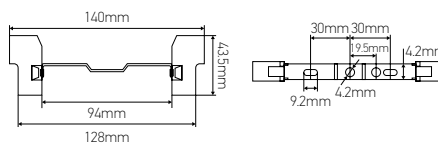

Treated steel bracket
140 x 14 x 43mm, fixing distance 60mm
Silicone cable, Brass tip
Double crimping

LAMP HOLDER WITH R7S BRACKET



260049

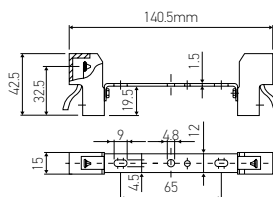

Steel
140 x 15 x 42.5mm

LAMP HOLDER WITH R7S BRACKET



260056

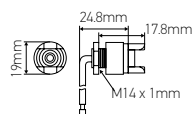

Ceramic nickel-plated brass
Steel
Silicone cable L. 250mm T 180°C

LAMP HOLDER WITH R7S BRACKET



260067

Lamp holder with bracket
Treated steel bracket
117.6 x 20 x 24mm, fixing distance 70mm
Center hole | Ø11mm

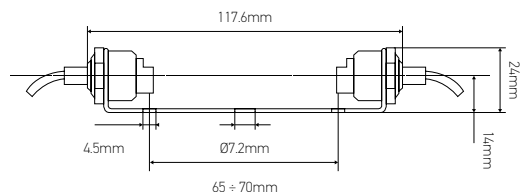

LAMP HOLDER WITH RX7S BRACKET



260078

RX7S Lamp holder with bracket
Treated steel bracket
150 x 24 x 26mm, fixing distance 70mm
Center hole | Ø11mm

LAMP HOLDER FOR "LINOLITE" LAMP S19



EN 60598



210853
S19

Lexan 740
To equip class II luminaires
(Ø x H) | Ø30 x 43mm

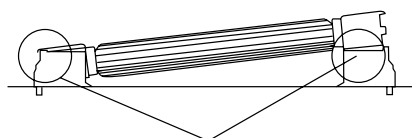

LAMP HOLDER AND CONNECTOR FOR E27 DCL LAMP



253013

2A 250V
Thermoplastic
White thermoplastic Lamp holder with detachable 2-pole plug + earth for subsequent connection of a class I or II luminaire for B22 lamp - 75W max



253003

6A 250V
Thermoplastic
Screw terminal
Cable to use | 0.5 to 1mm²

EN 61184
UTE C 61390
NFC 61601

ADAPTER FOR LAMP HOLDERS 60W Max.



EN 60238:2004
A1:2008



158265

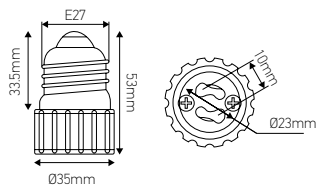

158267

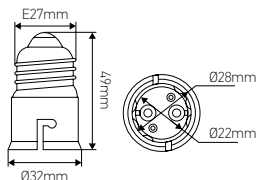

158269

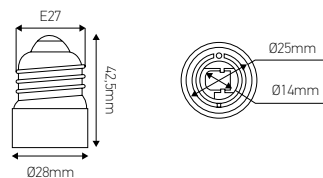

158530

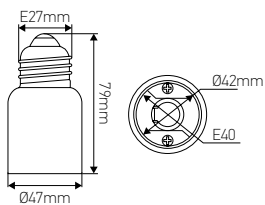

158531

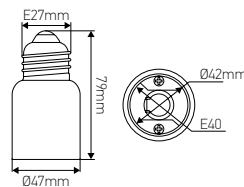

158459

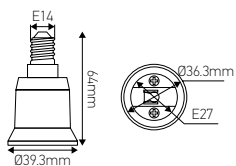

158465

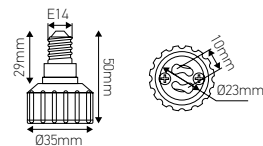

158463

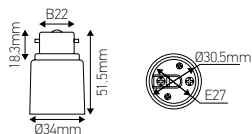

158461

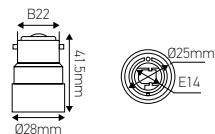

Ref.	Material	Color	
158265	plastic	white	E27 => GU10
158267	plastic	white	E27 => B22
158269	plastic	white	E27 => E14
158530	plastic	white	E27=> E40
158531	plastic	black	E27=> E40
158459	plastic	white	E14 => E27
158465	ceramic	white	E14=> GU10
158463	plastic	white	B22 => E27
158461	plastic	white	B22 => E14

Low Voltage Directive | 2006/95/EC, annex IV
Other versions available on request

ADAPTER FOR LAMP HOLDERS 60W Max.



158532

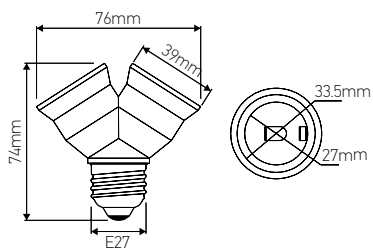

Ref.	Material		
158532	plastic	E27 => 2 x E27	12

Low Voltage Directive | 2006/95/EC, annex IV
Other versions available on request



TECHNICAL SOCKETS



DECO CABLES



CABLE 2m 2 x 0.75mm ²	130
REEL FABRIC CABLE.....	134
REEL PVC CABLE.....	137
HEAT-SHRINKABLE SLEEVE	140



302201



302202



302203



302204



105 x 35 x 105 mm

Cable type | H03VV-F
Double insulation
Ø6mm

ROUND COTTON CABLE 2 x 0.75mm²



189631



187531



189624



302001



105 x 35 x 105 mm

Cable type | H03VV-F
Double insulation
Ø6mm

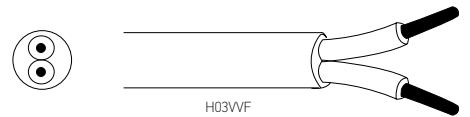

ROUND TEXTILE CABLE 2 x 0.75mm²



187534



187535



189601



187538



187537

Cable type | H03VV-F
Double insulation
Ø6mm



ROUND TEXTILE CABLE 2 x 0.75mm²



187539



302107



187582



302104



302105



187581



187580



302106



187536



189626



189627

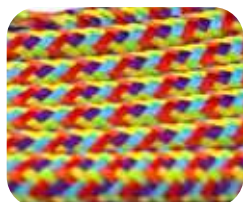

189609



189608



189607



189604



189638



189629



189643

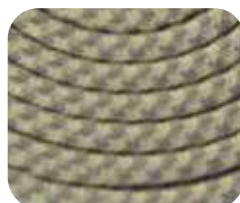

189632



189637



189605



189639



189634



189623



189640



189633

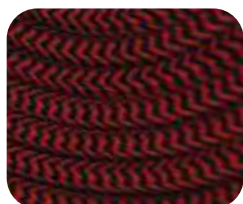

189625



187533



105 x 35 x 105 mm

Cable type | H03VV-F
Double insulation
Ø6mm

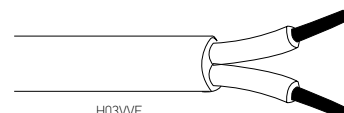

H03VVF



HEMP CABLE 2 x 0.75mm²



187598



189636

Cable type | H05V-K
Ø8mm



105 x 35 x 105mm

TWISTED CABLE 2 x 0.75mm²



189650



189651



189614



189617



189610



187532

Cable type | H05V-K
Double insulation
Ø6.5mm



105 x 35 x 105mm



237881



237886



237893



237894



237895

Cable type | H03VV-F
Double insulation
Ø5.6mm



FLAT TEXTILE CABLE 2 x 0.75mm²



237712

Cable type | H05VVH2-F
Double insulation
5.8 x 4mm

FLAT TEXTILE CABLE 2 x 0.5mm²



237571



237577

Cable type | SV0TM
Braided conductor wire, PVC sleeve
Simple insulation



TWISTED TEXTILE CABLE 2 x 0.5mm²

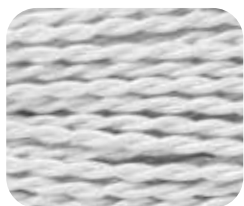

237043

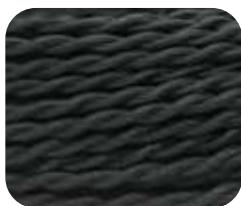

237051



237062

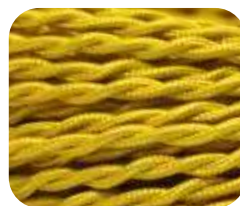

237077



237079



237094

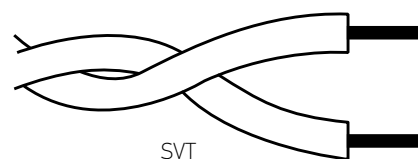

SVT

Cable type | SVT
Braided conductor wire, PVC sleeve
Simple insulation

TWISTED TEXTILE CABLE 2 x 0.5mm²

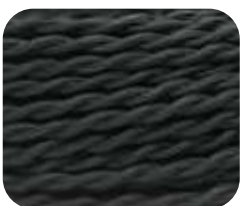

237941



237942

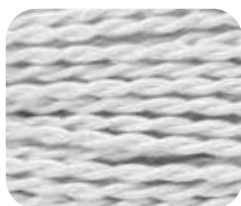

237943



237944

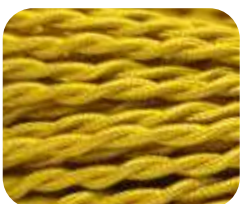

237947



237949

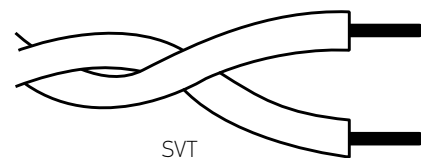

SVT

Cable type | H05V-K
Ø5mm
Simple insulation

TWISTED TEXTILE CABLE 2 x 0.75mm²



237133



237141



237142



237147



237149

Cable type | SVT
Braided conductor wire, PVC sleeve
Simple insulation

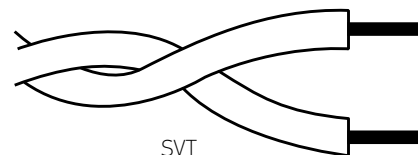

TWISTED TEXTILE CABLE 3 x 0.5mm²

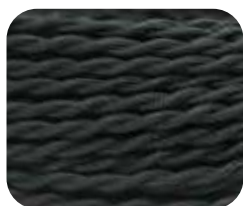

237331

Cable type | SVT
Braided conductor wire, PVC sleeve
Simple insulation

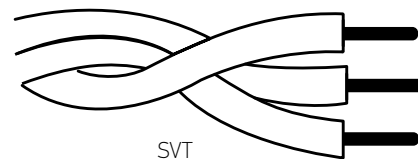

TWISTED TEXTILE CABLE 3 x 0.75mm²



237457

Cable type | SVT
Braided conductor wire, PVC sleeve
Simple insulation

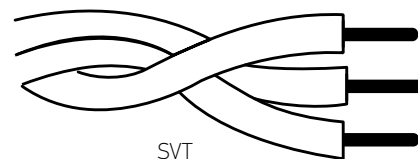



300/
500V



T 70°C



235011



235017



235025

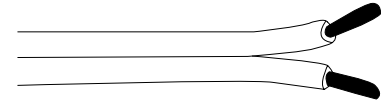

VDE8867

Cable type | VDE8867 2 x 0.3mm²
Dimensions | Ø1.5 x 3mm

FLAT PVC CABLE 2 X 0.5mm²



T 85°C



235147

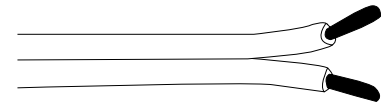

H03 VH-H

Cable type | H03VH-H
Simple insulation
Ø5.1 x 2.15mm

OVAL PVC CABLE 2 x 0.5mm²



T 85°C



236243



236251



236257



236285

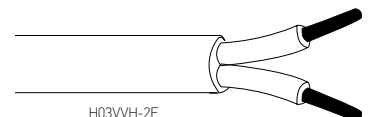

H03VVH-2F

Cable type | H03VVH-2F
PVC sleeve,
round PVC outer casing
Double insulation
Ø5.2 x 3.2mm

OVAL PVC CABLE 2 x 0.75mm²



236373



236381



236387



236398

Cable type | H03VVH-2F
PVC sleeve,
round PVC outer casing
Double insulation
Ø5.5 x 3.5mm



H03VVH-2F

ROUND PVC CABLE 2 x 0.75mm²



235833



235841



H03VVF

Cable type | H03VVF
PVC sleeve, round PVC outer casing
Double insulation
Ø5.4mm

ROUND PVC CABLE 3 x 0.75mm²

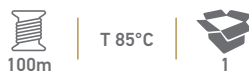

235913



235921



235927



H03VVF

Cable type | H03VVF
PVC sleeve,
round PVC outer casing
Double insulation
Ø3 x 0.75mm²

SINGLE CABLE 1 x 0.75mm²



235753

Cable type | H05VK
Flexible conductors Simple insulation
Ø2mm



H05VK



236982

Cable type | AWG20
Finishing | Teflon
Flexible cable
Simple insulation
Ø1mm

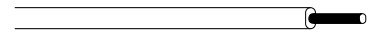

AWG20

HIGH TEMPERATURE ROUND PVC CABLE 3 x 0.75mm²



236527

Cable type | H03V2V2-F
Double insulation
Ø5.6mm

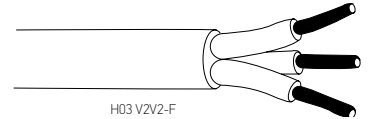

H03 V2V2-F



236974

Before shrinking | 7mm
 After shrinking | 4mm
 Cross-section | 1 x 0.7mm² - 1 x 0.4mm²
 Plasticized PVC, Heat Shrink Sleeve,
 transparent di-electric strength | 20KV/mm
 Shrink temperature | 120°C
 Simple insulation

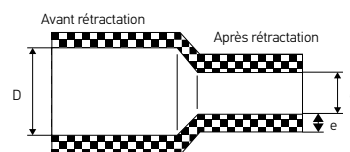





PRE-ASSEMBLED CABLES



PLASTIC CORD	144
TEXTILE CORD	148

PLASTIC CORD PLUG WITHOUT SWITCH 2 x 0.75mm² L.1.5m

T 70°C

2.5A
250V



CABLE EN 50525-2-11 2011
CEI EN 50525-2-11 2012
PLUG EN50075
IEC60884-1 3rd Ed. '02 A1 2006



241001

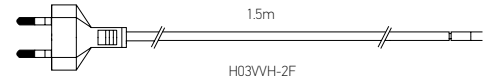

Cable type | H03VVH-2F
L. 1.5m with bipolar plug
Electro-welded accessory, crimped ends

PLASTIC CORD PLUG WITHOUT SWITCH 2 x 0.75mm² L.2m

T 70°C

2.5A
250V



CABLE EN 50525-2-11 2011
CEI EN 50525-2-11 2012
PLUG EN50075
IEC60884-1 3rd Ed. '02 A1 2006



241023



241041



241040

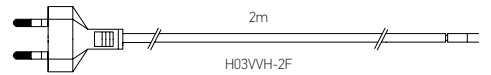

Cable type | H03VVH-2F
L. 2m with bipolar plug
Electro-welded accessory, crimped ends

PLASTIC CORD PLUG WITH SWITCH 2 x 0.75mm² L.1.5m



240523



240531



240540



240547

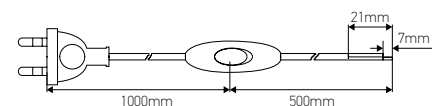

Cable type | H03VVH-2F
L. 1.5 m with two-pole plug and toggle switch

PLASTIC CORD PLUG WITH SWITCH 2 x 0.75mm² L.2m



240573



240581



240580



240587

Cable type | H03VVH-2F
L. 2 m with two-pole plug and toggle switch

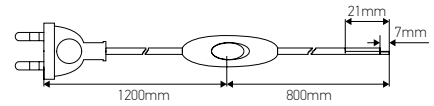

PLASTIC CORD PLUG WITH SWITCH 2 x 0.75mm² L.3m



240511

Cable type | H03VVH-2F
L. 3m with bipolar and toggle switch

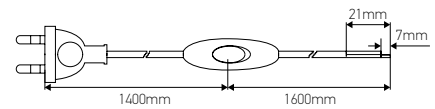

PLASTIC CORD PLUG WITHOUT SWITCH 3 x 0.75mm² L.2m



10/16A
250V



241563

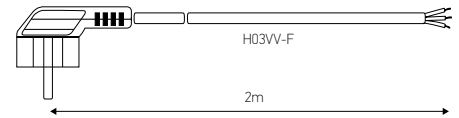

Cable type | H03VV-F
L.2m with double earth Euro-Schuko and switch
Crimped ends

PLASTIC CORD PLUG WITHOUT SWITCH 3 x 0.75mm² L. 4m



10/16A
250V



241581

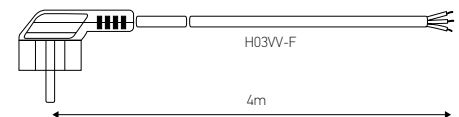

Cable type | H03VV-F
L.4m with Euro-Schuko double earth and switch
Crimped ends

PLASTIC CORD PLUG WITHOUT SWITCH 3 x 1mm² L.1.5m



241631

L.2m with Euro-Schuko earth and switch
Distance between switch and plug | 1.20m

CABLE WITH FOOT SWITCH + PLUG 2 x 0.75mm² L.3.5m



241313



241321



241350

L. 3.5m with footswitch & bipolar plug
Distance between switch and plug | 1m

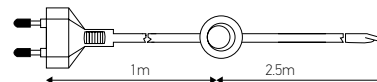

ELECTRIC CABLE WITH PLUG + FOOT SWITCH 3 x 0.75mm² L. 3.5m



241471

L.3.5m with double earth Euro-Schuko and switch
Distance between switch and plug | 1m

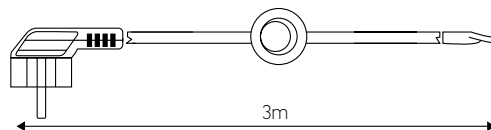

PRE-ASSEMBLED CABLES

PLASTIC PLUG CORD WITH SWITCH 3 x 0.75mm² L.2m



241451



241467

L.2m with Euro-Schuko earth and switch
Distance between switch and plug | 1.20m

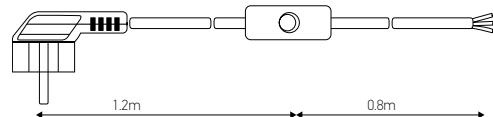

TEXTILE CORD WITH PLUG + TRANSPARENT SWITCH 2 x 0.75mm² L. 2m



241611



241633



241634



241635



241636



241638



241639

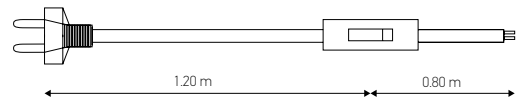

Cable type | H03VVH2-F
L.2m with toggle switch and bipolar plug
Distance between switch and plug | 1.20m

CORD WITH DIMMER FOR LED AND HALOGEN 2 x 0.75mm² L.2m



V. AC
100-240V
50/60Hz



260011

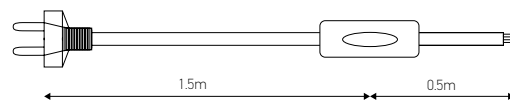

L. 2 m with bipolar plug and dimmer
Distance between switch and socket |1.50m
Suitable for LED
Power Range | Halo 40/160W, LED 4/100W

CABLE WITH PLUG + HALOGEN DIMMER 2 x 0.75mm² L. 2m

2.5A
250V



261122



261137



261133

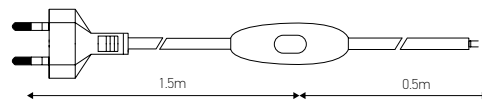

L. 2 m with bipolar plug and dimmer
Distance between switch and plug |1.50m
Power range | Halo 40/160W, LED 4/100W



PLUGS

MALE PLUG.....	152
BIPOLAR PLUG.....	152
FEMALE PLUG MOBILE BASE	153
MALE CAP PLUG	153



MALE PLUG



250554



250555



250556



250557

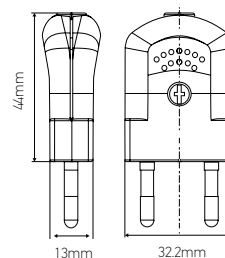

Cable to use | H03VV-F, H05VV-F,
H03VH2-F
Screw terminals

BIPOLAR PLUG + EARTH



250893



250891



250897

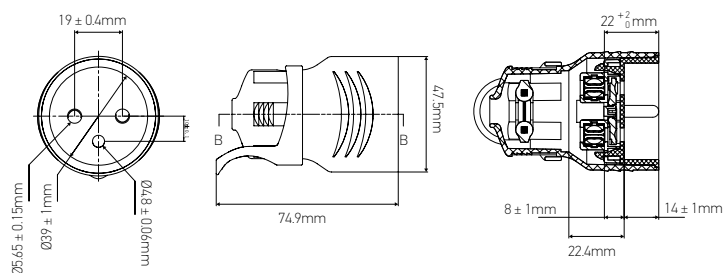

Cable to use | 0.75 - 1.5mm²



250887

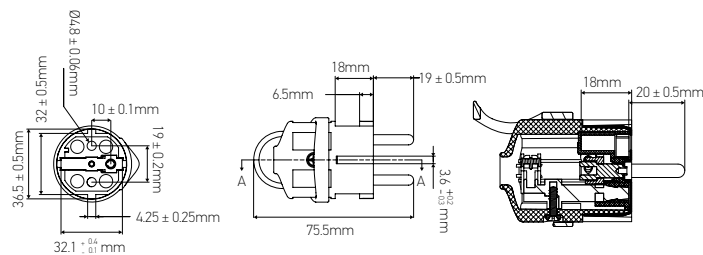

Cable to use | 0.75 - 1.5mm²



250781



250786

Pins | Ø4.8mm
With protective eclipses

MOBILE BASE WITH STRAIGHT OUTLET FEMALE PLUG

IEC 60598-1:2015
IEC 60598-2-1



250784



250785

16A 2P+T
Product Type | Current plugs
Materials | Plastic
For cable Ø max. | 11mm
Ø42 x 69mm

HOODED PLUG WITH RING MALE PLUG

IEC 60598-1:2015
IEC 60598-2-1



250787



250788

16A 2P+T
Product Type | Current plugs
Materials | Plastic
44 x 36 x 59mm



SWITCHES

DECORATION	156
CLASSICS	158

BIPOLAR SWITCH

EN 61058



155733



155735



EN 61058



155463



155731

Type | By hand
Screw terminals
Cable to use | H03VVH2-F
For flat or round transparent cable 2 x 0.75 mm²
60 x 26 x 15mm

SWITCH WITH EARTH

EN 61058



155736



155737



155738

Type | By hand
Screw terminals
Cable to use | H03VVH2-F
For flat cable 2 x 0.75mm² and round cable 2 x 0.75mm² and 3 x 0.75mm²
60 x 26 x 15mm

SLIDER SWITCH

EN 61058-1



246751



246763

Type | By hand
Slider switch
Brass contacts
Screw terminals
Cable to use | H03VVH2-F
For 2 x 0.75mm² - Connection for neutral

BIPOLAR TOGGLE SWITCH

EN 61058-1



246941
with earth



246953
with earth

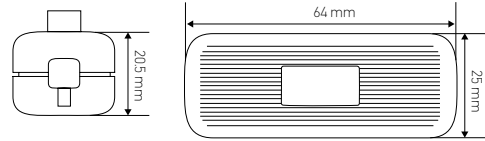

Type | By hand
Brass contacts
Screw terminals
Clip-on housing
Cable to use | H03VVF

PUSH SWITCH



245115
automatic assembly



245209
screw mounting



245695

EN 61058-1:2002
EN 61058-1:2002/A2:2008
EN 61058-1-1:2016
EN50581:2012

Type | By hand
Screw terminals
24,2 x 12 x 9,7mm

COUNTER NUT
Stamped steel
Ø12.3mm

CONICAL RING FOR PUSH SWITCH



245457



245465

Brass
Nickel-plated brass

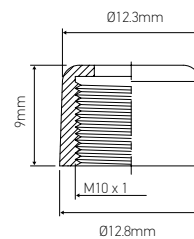

245443

Polystyrene
Height | 7mm
Bronze Contacts - Push Terminals
24,2 x 12 x 19mm

EN 61058-1
UL 1054
CSA C22.2

SINGLE-POLE TOGGLE SWITCH, CLIP-ON MOUNTING AND SCREW TERMINALS

EN 61058-1

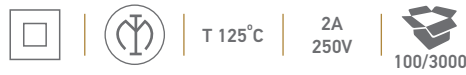

245801



245803

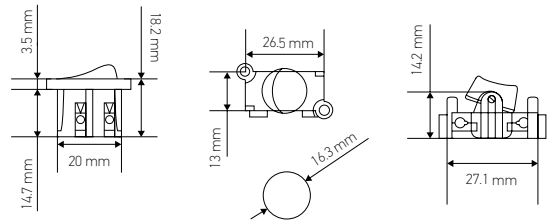

Type | To be built-in
2-hole plate

SINGLE POLE DOUBLE IGNITION SWITCH

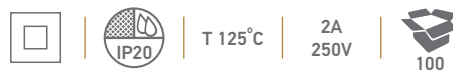

245824

SWITCHES

SINGLE-POLE TOGGLE SWITCH FIXED BY SCREWS AND CRIMP TERMINALS



245821



245823

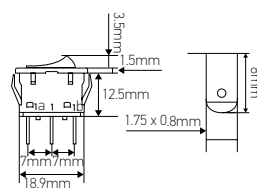

FOOT SWITCH WITH EARTH Ø65mm



2A
250V



246051



246063



246077



246088

Type | On foot
Screw terminals
Cable to be used | H03VV-F
For round cables | 3 x 0.75mm²
Cord grip | by a plastic plate and two screws
(Ø x H) | Ø65 x 23mm



"TUMBLER" SWITCH WITH KNURLED RING AND LOCKNUT



247325

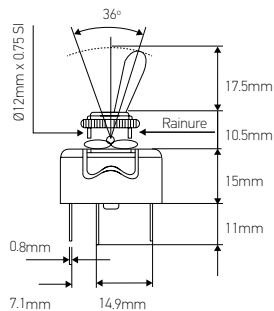

Type | By hand
 15A / 250Vac _ 12Vcc
 Knurled ring & internal locking nut. Ø12mm comes and goes possible

SINGLE-POLE PULL SWITCH



EN 61058-1



245795

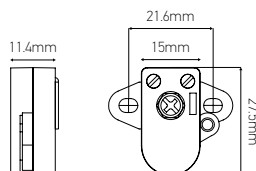

Type | Screw terminal
 2-hole plate
 27,5 x 15 x 11,4mm

DOOR CONTACT SWITCH



NF C-61314
 REACH



247763

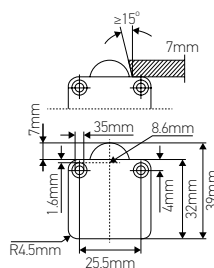

Roller actuator



DRIVERS

HAND DIMMER	164
FOOT DIMMER	164
HAND ROTARY VARIATOR	165
UNIVERSAL FOOT DIMMER	165

LED/HALOGEN HAND DIMMER



260001



260002



260003



260007

For halogen and LED
Continuous regulation
Soft start and soft stop
Cable to use | H03VV-F
Halogen | 25÷160W (220-240V~ - 50/60Hz) - 25÷80W (110-127V~ - 50/60Hz)
LED | 4÷25W (220-240V~ - 50/60Hz) - 4÷25W (110-127V~ - 50/60Hz)

LED HAND DIMMER



158852

For LED
1-20W
Integrated push button
70 x 28,8 x 18,1mm

LED FOOT DIMMER



158860

LED | 1 - 85W
Integrated push button
Ø65 x 31,2mm

ROTARY HAND DIMMER FOR LED / HALOGEN



158858

10-150W Inc
11-75W CFL
4-60W LED
Universal hand dimmer
97 x 30,5 x 28,5mm

UNIVERSAL FOOT DIMMER WITH CURSOR



260723



260721



260727

Halogen 40-250W, LED 4-100W
Advanced technology
Light indicator
115 x 71 x 39mm



260821

Halogen 40-250W, LED 4-100W
Advanced technology
109 x 61 x 33mm



WALL SOCKETS WALL SWITCHES AND POWER STRIP

WALL SOCKETS.....	168
WALL SWITCHES	169
POWER STRIP.....	171



NEW



200606



200607

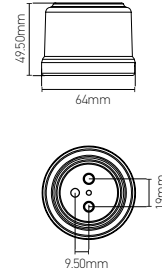

4 screw connection

PORCELAIN SOCKET WITH EARTH



200604



200605

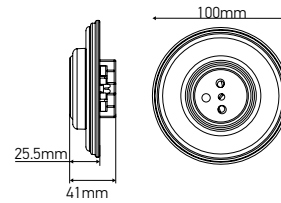

Has earth connection.
Screw connection by 4





200600



200601

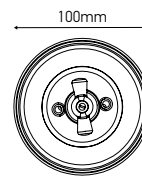
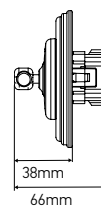

Does not have a ground connection but operates back and forth.
Ready to ride.
Screw connection by 4

SURFACE MOUNTED PORCELAIN SWITCH



200602



200603

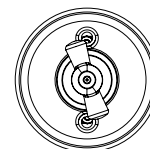
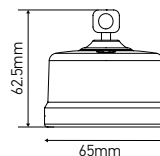

Does not have a ground connection but operates back and forth.
Screw connection by 4



V-PRO LED WALL DIMMER

CE | 1-120W | V. AC
220-250V



320000



320001

86 x 86 x 48mm





16A
250V



252111

Number of sockets | 6
Pre-wired
With cable | H05VV-F 3G 1.0mm²
Max watts | 3680W 250V ~ 50Hz

MULTI SOCKET



158705
4 sockets



CHANDELIER COMPONENTS

ALL THE SMALL HARDWARE..... 174

CLAPPER RING



281492

Ref.	Material	Dim. H _{mm}
281492	zinc plated cut steel	34mm

With locking screw and grounding terminal

SLIDING RING



281836

Ref.	Material	Dim. Ø _{mm}
281836	brass	Ø11mm

With stop screw for Ø10/11mm tube

TUBE FOR CEILING CUP



282027



282039



282049



282171

Ref.	Material	Thread	Dim. Ø x L _{mm}
282027	scoured brass	male 10 x 1	Ø10 x 70mm
282039	scoured brass	male 10 x 1	Ø10 x 90mm
282049	antique brass	male 10 x 1	Ø10 x 90mm
282171	chrome-plated brass	male 10 x 1	Ø10 x 90mm

FIGARO CHAINS, UNWELDED

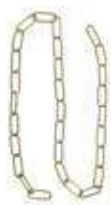

285664

Ref.	Material	Links	Wire thickness	Dim.
285664	brass-plated steel	34mm	Ø2.8mm	1m

OVAL CHAIN



286230

Ref.	Material	Links	Wire thickness	Dim.
286230	brass-plated steel	30mm	Ø3.2mm	1m



RINGS



287372



287594

Ref.	Material	Thread	⊖ Ø x H _{mm}
287372	brass	male 10 x 1	26 x 35
287594	brass	female 10 x 1	27 x 42

Mobile, male connection 10 x 1, weight supported 1kg



287605

Ref.	Material	Thread	⊖ Ø x H _{mm}
287605	molten brass	female 10 x 1	27 x 15



288272

Ref.	Material	Thread	⊖ Ø x H _{mm}
288272	molten brass	female 10 x 1	-

SMOOTH TUBE



300825

Ref.	Material	Thread	Ømm x Lm
300825	brass	cover tube	Ø12 x 1m

Inner diameter | Ø11mm
Outer diameter | Ø12mm

THREADED TUBE



302195

Ref.	Material	Thread	Ø x Lmm
302195	brass	international thread 8 x 1	Ø8 x 20

THREADED TUBE



300369



300370

Ref.	Material	Thread	Ø _{mm} x L _m
300369	brass	international 10 x 1	Ø10 x 1m
300370	galvanized steel	international 10 x 1	Ø10 x 1m



300382

Ref.	Material	Thread	Ø _{mm} x L _m
300382	galvanized steel	international 10 x 1	Ø10 x 2m

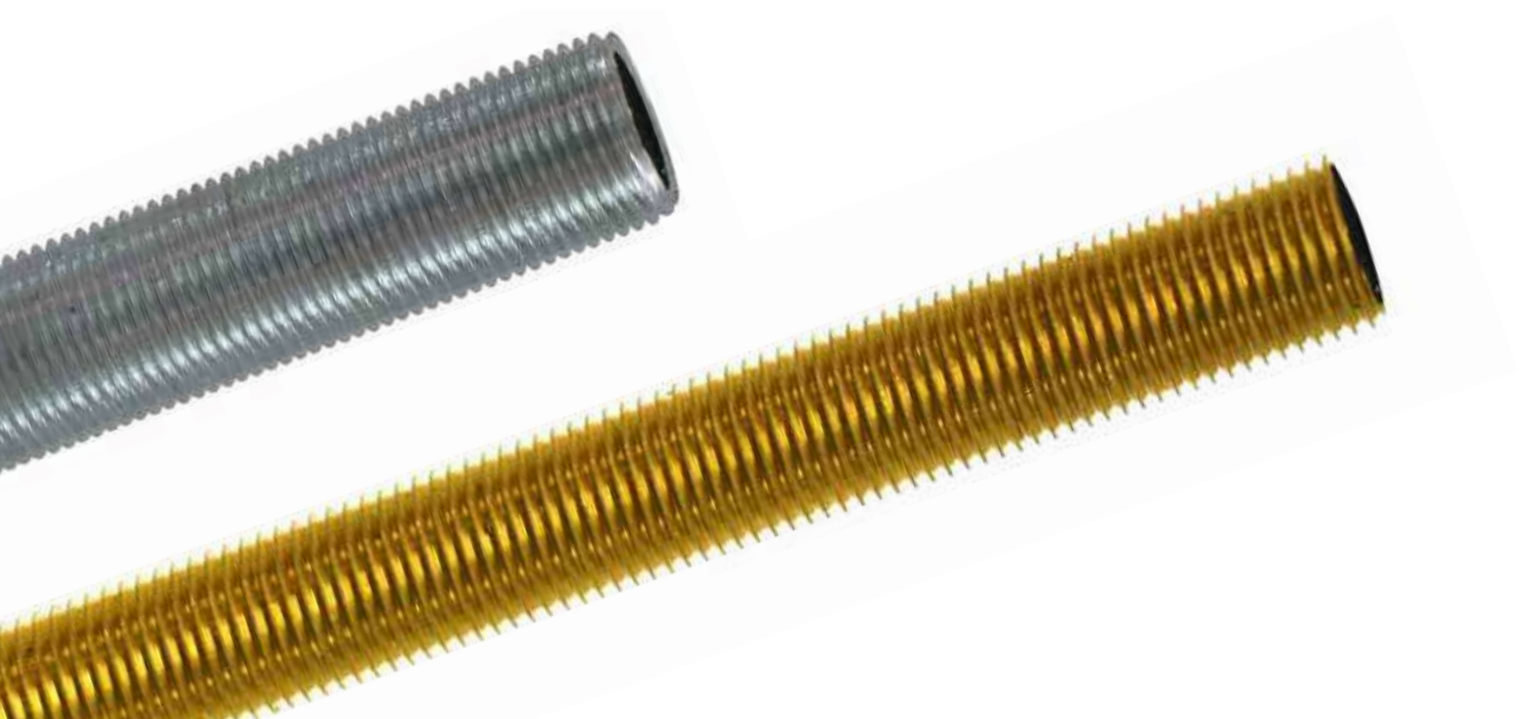

THREADED TUBE



International thread 10 x 1

Ref.	Length	
302257	10mm	100
302279	15mm	100
302281	20mm	100
302292	25mm	100
302303	30mm	100
302314	35mm	100
302325	40mm	100
302336	45mm	100
302347	50mm	100

Ref.	Length	
302448	100mm	500
302460	120mm	500
302471	130mm	500
302482	140mm	500
302493	150mm	500
302537	190mm	500
302548	200mm	500
302551	300mm	500



302598



302554

Ref.	Material	Thread	Ømm x Lmm
302598	galvanized steel	international 10 x 1 with flat	Ø10 x 50
302554	galvanized steel	international 10 x 1 with flat	Ø10 x 15

Internal Ø | 27mm



302643

Ref.	Material	Thread	Ømm x Lmm
302643	galvanized steel	International 13 x 1	Ø13 x 50

GROUNDING TERMINALS FOR SOCKET



231905

Ref.	Thickness	Hole	Width	Length
231905	0.9mm	Ø10.5mm	15mm	30mm

6 SIDED NUT



303121



303598



303619



303620



303675



331972

Ref.	Material	Thread	Ø _{mm} x L _{mm}
303121	turned brass	nut no beak	Ø11 x thickness 2 SP14
303598	turned brass	international thread 10 x 1	thickness 2 SP14
303619	zinc plated cut steel	international thread 10 x 1	thickness 2.5mm SP14
303620	zinc plated cut steel	international thread 10 x 1	thickness 4mm SP14
303675	galvanized steel	international thread 8 x 1	thickness 4mm SP11
331972	brass	thread 4 x 70	thickness 3mm SP7

CHANDELIER END FITTING



309610



309721



309732

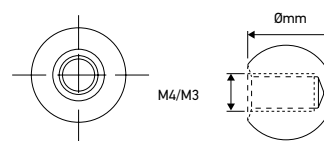

Ref.	Material	Thread	Ø mm
309610	brass	female 3 x 50	Ø8
309721	brass	female 4 x 70	Ø10
309732	brass	female 4 x 70	Ø14

STEM BALL



309765

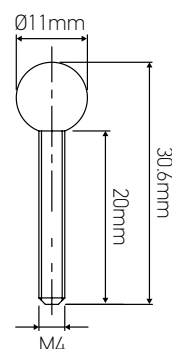

Ref.	Material	Thread	ØxHmm
309765	brass	female thread 4 x 70	Ø11 x 20

CHANDELIER COMPONENTS

ACORN



331728

Ref.	Material	Thread
331728	brass	without base, female 4 x 70

BUSHING



331840

Ref.	Material	Thread
331840	brass	male 10 x 1, female 4 x 70

TURNTD NIPPLE



331951

Ref.	Material	Thread	Lmm
331951	brass	turned nipple 4 x 70	15

THREADED WASHER



303731



303842

Ref.	Material	Thread	Ømm x Lmm
303731	brass	connection 10 x1	Ø13 x thickness : 2.5
303842	brass	connection 10 x1	Ø20 x thickness : 20

KNURLED WASHER



304894

Ref.	Material	Thread	Ømm x L _m
304894	galvanized steel	connection 10.5	Ø18

WASHER



304126



304237



304783



304561

Ref.	Material	Hole	Ømm x L _m
304126	brass	Ø11	Ø24 x thickness : 1
304237	brass	Ø11	Ø18 x thickness : 1
304783	treated steel	Ø11	Ø17.3 x thickness : 1.5
304561	galvanized steel	Ø10.5	Ø40 x thickness : 1

Spring washer*

PVC WASHER



304905



304916



304927



304938

Ref.	Material	Thickness mm	Hole mm	Ømm
304905	PVC	2	Ø10.2	Ø14
304916	PVC	2	Ø10.2	Ø22
304927	PVC	2	Ø10.2	Ø31
304938	PVC	2	Ø13.5	Ø51

MALE 6 SIDED BUSHING WITH FLANGE

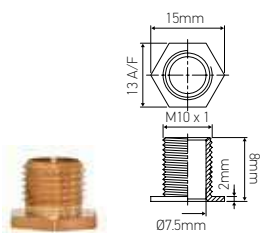

305421

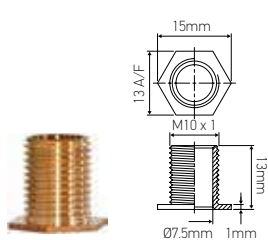

305467

Ref.	Material	Thread	H _{mm}
305421	brass	international thread 10 x 1	8
305467	brass	international thread 10 x 1	13

MALE BUSHING WITH FLANGE

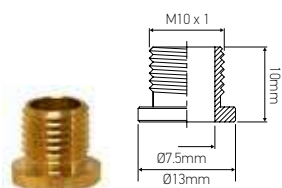

305478

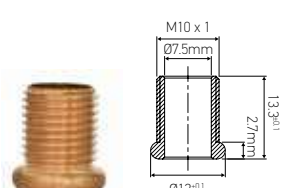

305590



305944

Ref.	Material	Thread	ØxH _{mm}
305478	brass	male connection 10 x 1	Ø13 x 10
305590	brass	male connection 10 x 1	Ø12 x 13
305944	brass	double male connection 10 x 1	Ø14 x 15

DOUBLE FEMALE COUPLING

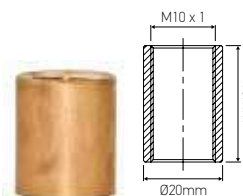

306340



306359



306574

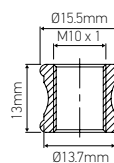

Ref.	Material	Thread
306340	brass	no Paris 16.85mm
306359	chrome-plated brass	international thread 10 x 1
306574	brass	international thread 10 x 1

DOUBLE FEMALE COUPLING



306351



306362

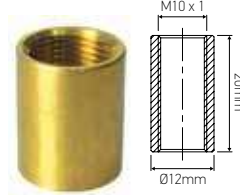

306473

Ref.	Material	Thread	ØxH _{mm}
306351	brass	international thread 10 x 1	Ø12 x 20
306362	brass	international thread with 10 x 1 locking screw	Ø14 x 15
306473	brass	international thread 13 x 1	Ø16 x 20

MALE & FEMALE BUSHING

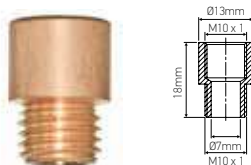

306796

Ref.	Material	Thread	ØxH _{mm}
306796	chrome-plated brass	international thread 10 x 1	Ø13 x 18

SOLDERING BUSH

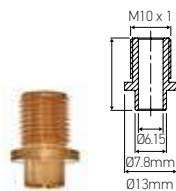

306929

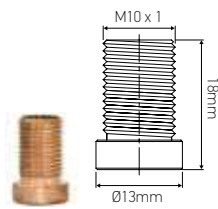

306930

Ref.	Material	Thread	Description	ØxH _{mm}
306929	brass	international thread 10 x 1	With 8mm flange	Ø13 x 18
306930	brass	international thread 10 x 1	for Ø8mm tube	Ø13 x 18

REDUCTION NIPPLE

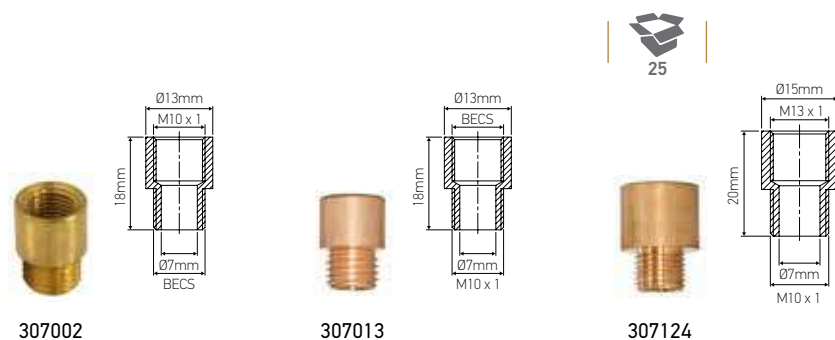

Ref.	Material	Thread	ØxH _{mm}
307002	brass	Male thread bushing(10.85 x 1.33), female 10 x 1	Ø13 x 18
307013	brass	Female thread bushing (10.85 x 1.33), male 10 x 1	Ø13 x 18
307124	brass	Female thread bushing 13 x 1, male 10 x 1	Ø15 x 20

HICKEY



Ref.	Material	Thread	ØxH _{mm}
307346	brass	10 x 1 female thread with locking screws	Ø14 x 20
307350	brass	10 x 1 female thread with locking screws	Ø18 x 20
307902	brass	10 x 1 male and 8 x 1 female thread	Ø13 x 10

NIPPLES ON THIN PLATE



Ref.	Material	Thread	Spacing _{mm}	Hole _{mm}	L x W x H _{mm}
308136	galvanized steel	10 x 1 male thread nipple	38	Ø4	54 x 17 x 8
308147	galvanized steel	10 x 1 male thread nipple	38	Ø10	54 x 17 x 13

BUSHING ON PLATE WITH 2 HOLES



308470



308482

Ref.	Material	Thread	Spacing mm	Hole mm	ØxHmm
308470	brass	male 10 x 1	17	Ø3	Ø25 x 9
308482	chrome-plated brass	male 10 x 1	17	Ø3	Ø25 x 9



308692



308702



308713

Ref.	Material	Thread	Spacing mm	Hole mm	ØxHmm
308692	brass	male 10 x 1	17	Ø3	Ø40 x 9
308702	chrome-plated brass	male 10 x 1	17	Ø3	Ø40 x 7
308713	brass	female 10 x 1	17	Ø3	Ø40 x 7

ROUND TUBE BALL CONNECTOR



309007

Ref.	Material	Thread	Dim. mm
309007	brass	brass ball bearing, double female 10 x 1	Bottom Ø18

TURNED BRASS PIPES



309420



309431

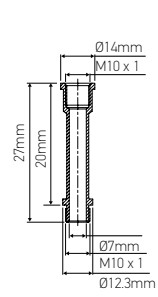

309420

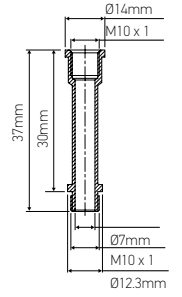

309431



309442



309453



309464

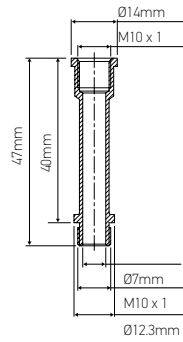

309442

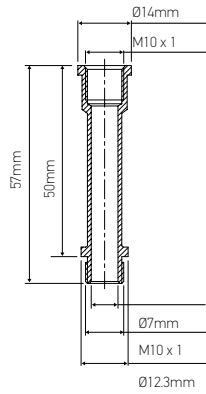

309453

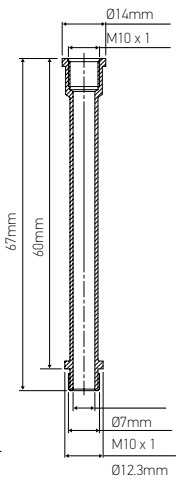

309464



309475



309486



309497



309509

Ref.	Material	Thread	Bottom Ø x L _{mm}
309420	turned brass	male and female 10 x 1	Ø14 x 20
309431	turned brass	male and female 10 x 1	Ø14 x 30
309442	turned brass	male and female 10 x 1	Ø14 x 40
309453	turned brass	male and female 10 x 1	Ø14 x 50
309464	turned brass	male and female 10 x 1	Ø14 x 60
309475	turned brass	male and female 10 x 1	Ø14 x 70
309486	turned brass	male and female 10 x 1	Ø14 x 80
309497	turned brass	male and female 10 x 1	Ø14 x 100
309509	turned brass	male and female 10 x 1	Ø14 x 120

CHANDELIER END FITTING



310127

Ref.	Material	Thread	ØxH _{mm}
310127	brass	female thread 10 x 1	Ø16 x 20mm



CHROME PLATED BRASS TURNED PIPES



310012



310034

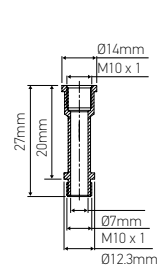

310012

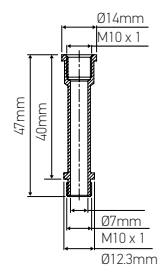

310034



310078



310089

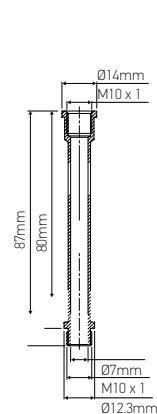

310078

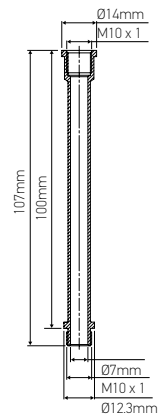

310089

Ref.	Material	Thread	Base Ø x L _{mm}
310012	chrome-plated brass	male and female 10 x 1	Ø14 x 20
310034	chrome-plated brass	male and female 10 x 1	Ø14 x 40
310078	chrome-plated brass	male and female 10 x 1	Ø14 x 80
310089	chrome-plated brass	male and female 10 x 1	Ø14 x 100

THREADED WASHER



320486

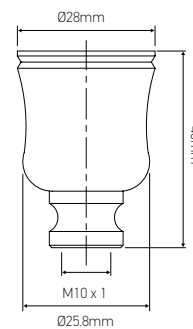

Ref.	Material	Thread	ØxH _{mm}
320486	brass	female 10 x 1	Ø28 x 41

LAMP HOLDER COVER



320596

Ref.	Material	For lamp holder	Hole	ØxH _{mm}
320596	brass	E27	Ø10,2	Ø40,5 x 35

1/2 SPHERE LAMP HOLDER COVER



320719

Ref.	Material	ØxH _{mm}
320719	varnished polished brass	Ø39 x 19

CUP



321626

Ref.	Material	Hole mm	Dim. Ø _{mm}
321626	brass	Ø11	Ø100

EXTENSION



330573



330215



330237

Ref.	Material	Thread	ØxH _{mm}
330573	varnished polished brass	male and female 10 x 1	Ø13 x 47mm
330215	chrome-plated brass	male and female 10 x 1	Ø13 x 47mm
330237	chrome-plated brass	male and female 10 x 1	Ø12,1 x 80mm



330359



330697

Ref.	Material	Thread	ØxH _{mm}
330359	chrome-plated brass	male and female 10 x 1	Ø9,1 x 250
330697	varnished polished brass	male and female 10 x 1	Ø9,1 x 300mm

SLIDING EXTENSION TUBE



330719

Ref.	Material	Thread	Description
330719	varnished polished brass	male 10 x 1	fixed part Ø10mm, sliding part Ø8mm sliding from 180 to 300mm

CLUSTER BODY



335715
2 outputs



335726
3 outputs

Ref.	Material	Thread	Hole mm	Ømm
335715	brass	2 male connection nipples 10 x 1	Ø8,2	Ø40
335726	brass	3 nipples male connection 10 x 1	Ø8,2	Ø40

PLIER



336501

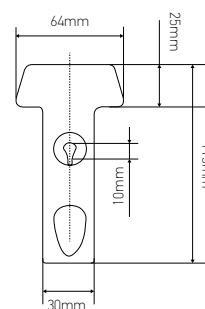

Ref.	Material	Livery
336501	nylon	disassembled

BALL JOINTS



337724

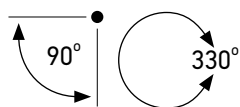

Ref.	Material	Thread	Strength	ØxH _{mm}
337724	chrome-plated brass	male arm 8 x 1 articulated 90° 360° rotation with lock female connection 8 x 1 international thread	3kg	Ø13 x 32

BALL JOINT



337009



337020

Ref.	Material	Thread	Strength	Ømm
337009	brass	male and female 10 x 1 360° rotation with lock international thread	6kg	Ø16 x 38
337020	chrome-plated brass	male and female 10 x 1 360° rotation with lock international thread	6kg	Ø16 x 38



337010



337034

Ref.	Material	Thread	Strength	ØxHmm
337010	chrome-plated brass	10 x 1 female connection with stop screw male arm 10 x 1 articulated 90° 360° rotation with lock international thread	5kg	Ø16 x 51
337034	brass	10 x 1 female connection with stop screw male arm 10 x 1 articulated 90° 360° rotation with lock international thread	5kg	Ø16 x 51

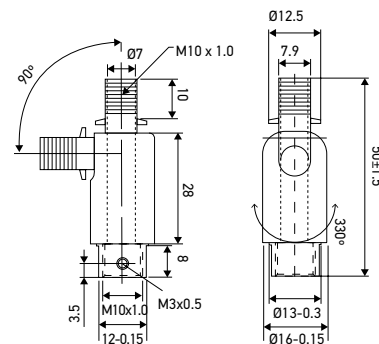

337132



Ref.	Material	Thread	Strength	ØxHmm
337132	chrome-plated brass	10 x 1 female connection with stop screw male arm 10 x 1 articulated 90° 360° rotation with lock international thread	14kg	Ø16 x 57.5

BALL JOINT



Ref.	Material	Thread	ØxH _{mm}
336674	brass	male and female ball joint adjustable by key international thread	Ø19 x 23
336785	brass	male and female ball joint adjustable by key international thread	Ø19 x 34
336907	chrome-plated brass	double female ball joint adjustable by key international thread	Ø13.5 x 35.5

CABLE PASSAGE CONNECTION

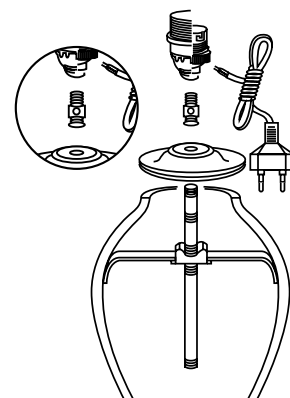

Ref.	Material	Thread	Height mm
341190	brass	male and female 10 x 1	27
142529	chrome metal	male and female 10 x 1	27

BIMETAL

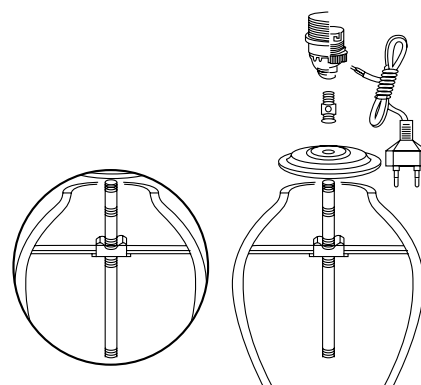

Ref.	Thread	Spacing mm	ØxH _{mm}
341012	threaded 10 x 1, with articulated blades side hole for wire	80	Ø19
341056	threaded 10 x 1, with articulated blades side hole for wire	150	Ø16

CHANDELIER COMPONENTS

RIGID BLADE



341212



341234

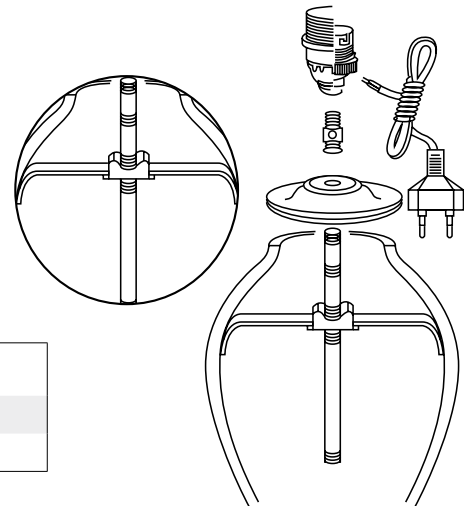

Ref.	Material	Thread	Spacing mm
341212	brass-plated steel	female 10 x 1	80
341234	brass-plated steel	female 10 x 1	110

EXTENSIBLE ADAPTOR

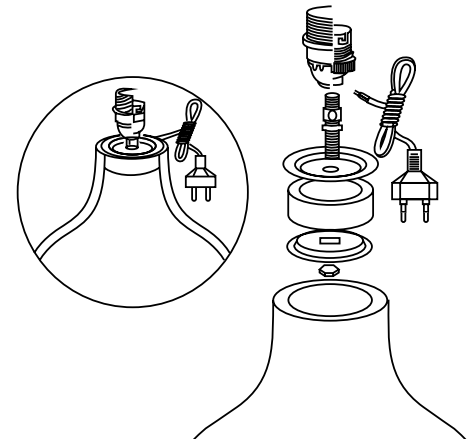
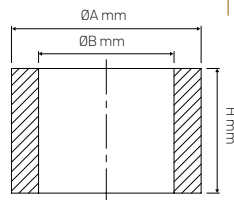

Ref.	ØA	ØB	H
340017	Ø35mm	Ø25mm	23mm
340039	Ø40mm	Ø30mm	23mm
340051	Ø45mm	Ø35mm	23mm
340073	Ø50mm	Ø40mm	23mm
340095	Ø55mm	Ø45mm	23mm
340137	Ø60mm	Ø50mm	23mm

Ref.	ØA	ØB	H
340159	Ø65mm	Ø55mm	23mm
340171	Ø70mm	Ø60mm	23mm
340193	Ø75mm	Ø65mm	23mm
340215	Ø80mm	Ø70mm	23mm
340237	Ø85mm	Ø75mm	23mm

EXTENSIBLE ADAPTOR

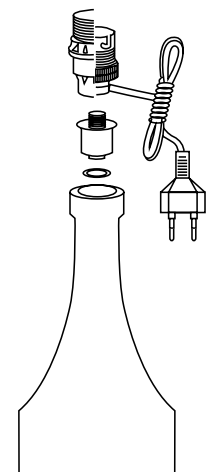
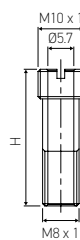

Ref.	Fitting Ø	H mm
342142	12 - 13	23
342164	14 - 15	23
342186	16 - 18	25
342208	19 - 21	28

Ref.	Fitting Ø	H mm
342230	22 - 24	28
342252	25 - 28	28
342274	29 - 32	28
342296	33 - 36	28

ADAPTATOR



342020

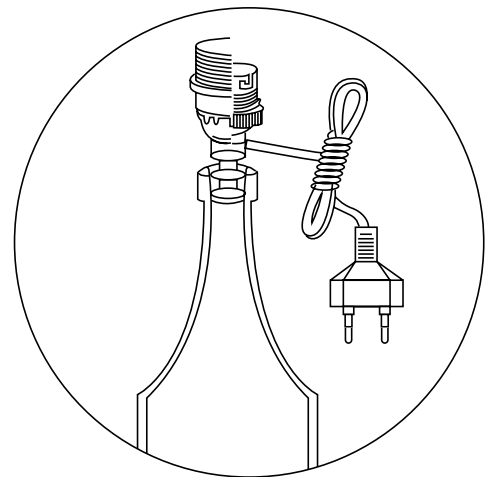

Ref.	Material	Thread
342020	polyethylene	male 10 x 1

STEPPED COVER



Canvas brass
Hole | Ø11mm
Thickness | 0.5mm

Ref.	Ø mm
346425	Ø25
346436	Ø30
346447	Ø35
346458	Ø40
346469	Ø45
346470	Ø50

Ref.	Ø mm
346481	Ø55
346492	Ø60
346513	Ø65
346524	Ø70
346546	Ø80
346568	Ø90

Ref.	Ø mm
346580	Ø100
346591	Ø105
346602	Ø110
346613	Ø115
346635	Ø125
346657	Ø135

CURVED COVER



346914

Ref.	Material	Hole mm	Ømm
346914	cloth brass	Ø11	Ø70

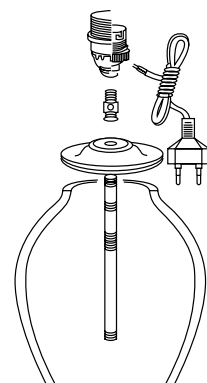

Example of use

SPOTISOL WITH RING



167438



Usable from -20°C to +110°C continuously
 Maximum power | 50W with roll Maximum power | 50W with roll insulation / 35W with blown insulation
 Self-extinguishing fire resistance UL 94 V2
 Height | 105mm

GROMMET



232763



232771

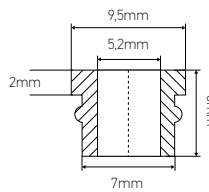

232803



232821



232837

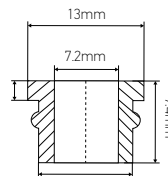

232911

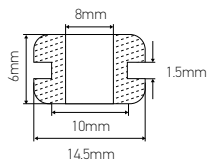

232901

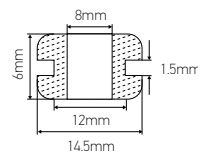

Ref.	Material	For tube	Passage of drivers
232763	polyethylene	Ø8	Ø5
232771	polyethylene	Ø8	Ø5
232803	polyethylene	Ø10	Ø7.2
232821	polyethylene	Ø10	Ø7.2
232837	polyethylene	Ø10	Ø7.2
232911	PVC	Ø10	Ø8
232901	PVC	Ø12	Ø6

CABLE CLAMP WITH STOP SCREW



230461



230573



230591

Ref.	Material	Outer Ø _{mm}	Inner Ø _{mm}
230461	nylon	Ø10.5	Ø6.5
230573	nylon	Ø12	Ø7.4
230591	nylon	Ø12	Ø7.4

CABLE RETAINERS

T 90°C



230133



230313

Ref.	Material	For cable	Thickness mm
230133	nylon	H03VV-F, H05VV-F	2
230313	nylon	H03VV-F	2

T 110°C



230349



Ref.	Material	For cable	Thickness mm
230349	nylon	H03VV-F	2

CABLE CLAMPS WITH LOCKING SCREWS

T 110°C |  100/1000



230603



230611



230613



230619

Ref.	Material	Thread	Ø _{mm}
230603	nylon	female 10 x 1	Ø7
230611	nylon	female 10 x 1	Ø7
230613	nylon	female 10 x 1	Ø6.5
230619	polycarbonate	female 10 x 1	-

T 90°C |  100/1000



230723



230731

Ref.	Material	Thread	Outer Ø _{mm}	Inner Ø _{mm}
230723	nylon	male connection 10 x 1	Ø13	Ø8.4
230731	nylon	male connection 10 x 1	Ø13	Ø8.4

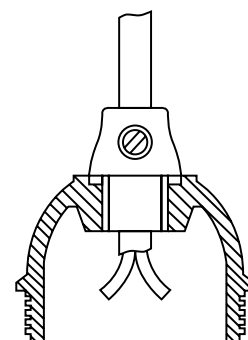

| T 100°C |



230991

Ref.	Material	Thread
230991	nylon	male connection 10 x 1

CABLE CLAMP

T 85°C



231003



231011

Ref.	Material	Thread
231003	nylon	male connection international thread 10 x 1
231011	nylon	male connection international thread 10 x 1

T 115°C



231029

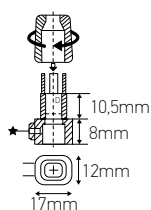

231129



231139

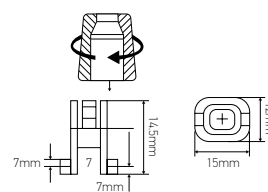

Ref.	Material	Thread
231029	polycarbonate	female connection, thread length 10.5mm
231129	polycarbonate	for socket, double female socket hole 10mm
231139	polycarbonate	For socket, 10mm smooth hole base



231159

Ref.	Material	Thread	ØxH _{mm}
231159	polycarbonate	female cap 10 x 1	Ø14.8 x 18.5

LAMP HOLDER INSULATOR

T 100°C



231507



231494

Ref.	Material	For lamp holder	For cable
231507	nylon	E27	H03VVH-2F
231494	nylon	E14	H03VVH-2F

Tube, tip

ISOSTOP TUBE

T 85°C



231614



231627

Ref.	For lamp holder	For cable
231614	E14	H03VVH-2F
231627	E27	H03VVH-2F

With traction and rotation stop
White polyacetal
For E14/E27 Lamp holder

CONNECTION TUBE



T 90°C



231637

Stopping traction and rotation
For E14 Lamp holder metal connection stop screw or tapped
10 x 1 For E27 Lamp holder tapped base 10 x 1 exclusively

LOCKING CLAMP

T 85°C |  1000



231747

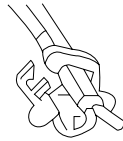

Insert the cable into the jaw of the ISOLATOP

Ref.	Material	For lamp holder	For cable
231747	white polyacetal	E27	H03VVH-2F

Side exit

LOCKING CLAMP FOR E14 LAMP HOLDER

T 85°C | 0.5A 250V |  1000



231734



Insert the cable into the jaw of the ISOLATOP

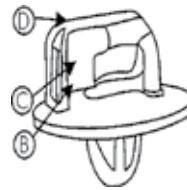

In order to obtain good tightening, tab B of the locking hook must be in contact with part C of the upper jaw

Isolatop, side outlet, white polyacetal, insulating tip, for H03 VVH - 2F cable

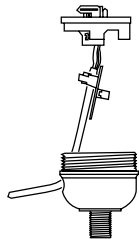

Traction and rotation stops for base sockets with Ø 5mm cable passage

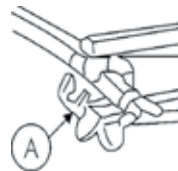

Using pliers, tighten the jaws on the cable and using a finger push back the hook has lock

CHANDELIER COMPONENTS

CABLE CLAMPS

T 110°C |  1000



232953

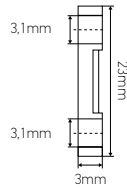
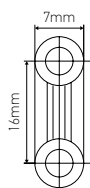

Ref.	Material	For tube
232953	nylon	Ø3.1

TRACTION STOPS

 | T 110°C
50 / 1000



231856
For E14 lamp holder



231869
For E27 lamp holder

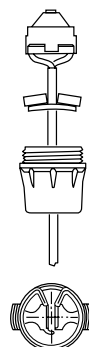

Pull stop for cable, Black Nylon, thickness 6mm, H03 VVH - 2F

SPOT FIXING RING MR16 x 10



380507

Ref.	Material	Thickness mm	Dim. mm	PCB Inner	PCB Outer
380507	steel	1.3	Ø60	-	-

CONNECTOR FOR WOODEN LAMP BASE

 | 100/1000



232561

Ref.	Material	Thread	Ø mm
232561	polyamide	male connection 10 x 1	Ø10

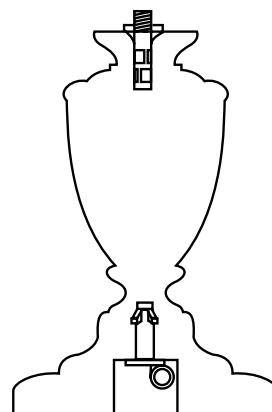

TWO-LAMP HOUSING

EN 60598

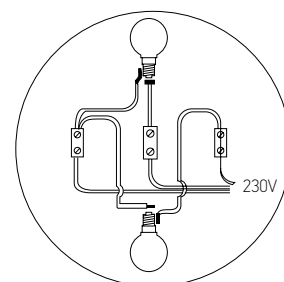
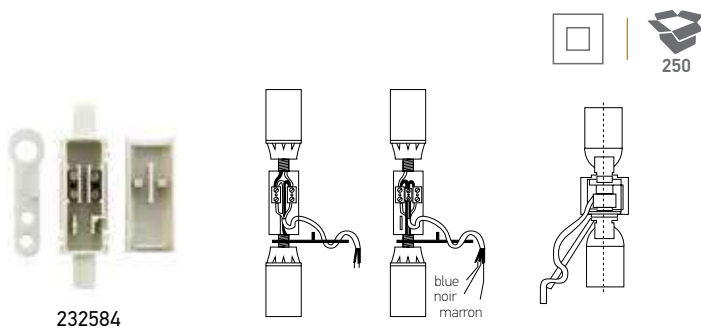

Clip closure
Lamp holder not included

Ref.	Material	Thread	For lamp holder	For cable
232584	thermoplastic	double male connection 10 x 1	E14/E27	H03VVH-2F

INSULATION GROMMET



Ref.	For tube	Passage of drivers
232604	Ø7	Ø5.5
232619	Ø13	Ø7.5
232609	Ø10	Ø5.9
232617	Ø10	Ø5.9

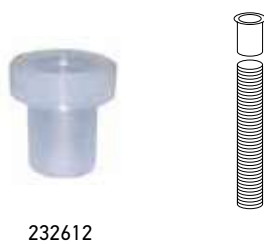

Ref.	Material	For tube	Passage of drivers
232612	polyethylene	Ø11	Ø6

CONNECTOR

T 90°C | IP 20 | 100/1000

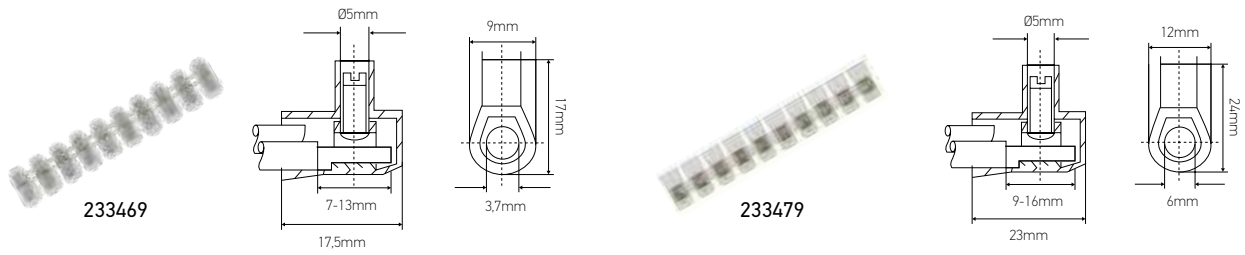

Ref.	Material	Poles	Section
233469	polycarbonate	10	2.5mm ² - 380V
233479	polycarbonate	10	6mm ² - 380V

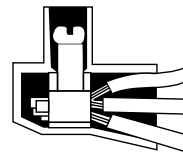

CONNECTOR BLOCK FOR CLASS I

16A 380V | | 100/1000

EN 60598

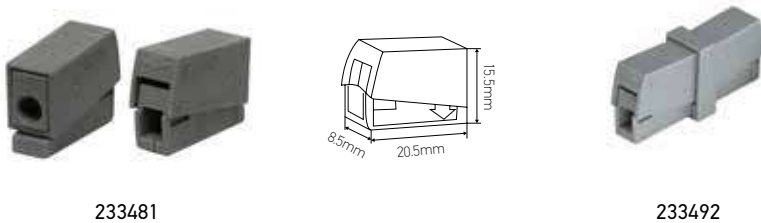

Ref.	Cable stripping	Connection terminals
233481	9-11mm	Simple
233492	9-11mm	double

Temperature 105°C continuously, 170°C peak
For 0.5 - 2.5mm² cable

PLUG-IN TERMINAL BLOCK SETS WITH CENTERING FLANGE

16A 80V | T 100°C | 1/100

EN 60998



Ref.	For fuse	Poles
233538	5 x 20mm	2
233542	5 x 20mm	3

Polyamide
Conductor section and stripping | 0.5 - 4mm² & 7mm
160°C peak
PTI600 tracking resistance
Male and female connector with protective tab
Up to 2.5mm²



233519

Ref.	Starters	Son	Color
233519	3	3	Grey

9-10mm
 3 x 0.08 – 4mm² "s" (2.5mm²"r" + "sr") 400 V/4kV IN 32 A



CHANDELIER COMPONENTS

CONNECTION BOXES FOR CLASS II

T 105°C | Glow wire 850° |  |  250

EN 60998



233709



233705

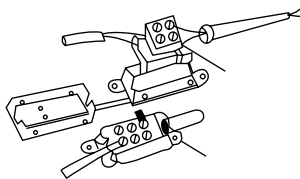

Removable terminal block
With sleeve
For connection to the installation
Length | 80mm
Clip closure
For oval cable / round cable



233717

Removable terminal block
Without sleeve
For oval cables
Thermoplastic insulation
Traction stop devices with clip closure

Ref.	Material	For cable	L x W x H _{mm}
233709	thermoplastic	round H03VV-F	42 x 19 x 11.5mm
233705	thermoplastic	oval H03VVH-2F	42 x 19 x 11.5mm
233717	thermoplastic	oval	46 x 19.5 x 11mm

SPLICING CONNECTOR

T 85°C

EN 60998



233502



233503



233505

Ref.	For cable	Poles	L x W x H _{mm}	
233502	0.2 to 4mm ²	2	13.1 x 8.3 x 18.6mm	50
233503	0.2 to 4mm ²	3	18.7 x 8.3 x 18.6mm	50
233505	0.2 to 4mm ²	5	29.9 x 8.3 x 18.6mm	25

With control levers

CONNECTOR BLOCK

T 105°C

Glow wire 850°



EN 60598



233731

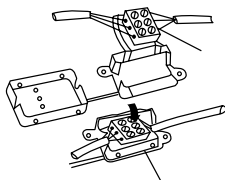

Ref.	Material	For cable	L x W x H _{mm}
233731	thermoplastic	2 x 0.75mm ² + 3 x 0.75mm ²	42.5 x 27.5 x 11.5

Thermoplastic
For cable
With cable clamp
Distribution by central fixing or by 3 side clamp outlets
Clip closure

DOMINOES 1 - 3 TERMINALS



260120

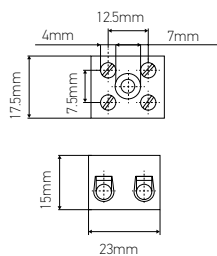

Ref.	Plot
260120	2

With steatin insulating body
Connection capacity | 2.5mm² section cable



GLASSWARE & ACCESSORIES

GLASSWARE.....	213
GLASSWARE ACCESSORIES.....	216
ACCESSORIES FOR KEROSENE LAMPS	227



189627
Round cotton
textile cable

187554
Lamp holder

189204
Shoe adapter

28631
Standard LED 6W

187590
Glassware

GLASSWARE FOR E27 LAMP HOLDERS



187590



187591

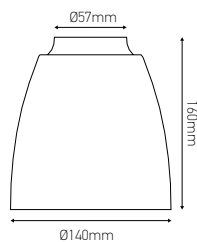

Ref.	Material	Finish	Claw mm
187590	glass	clear	Ø57
187591	glass	amber	Ø57

Compatible with the suspension claw ref 289204

GLASSWARE FOR MAZDA LAMPS



365063



365074



365085



365096

Ref.	Collar mm	Finish	ØxH _{mm}
365063	Ø28	opal	Ø160 x 140
365074	Ø28	opal	Ø205 x 190
365085	Ø40	opal	Ø205 x 190
365096	Ø40	opal	Ø260 x 220

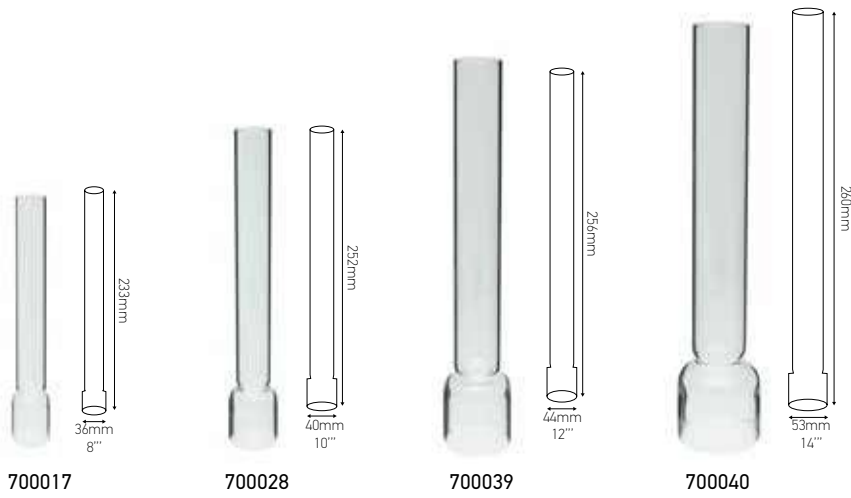

Ref.	Finish	KOSMOS	ØxH _{mm}
700017	clear	8"	Ø36 x 233
700028	clear	10"	Ø40 x 252
700039	clear	12"	Ø44 x 256
700040	clear	14"	Ø53 x 260



Ref.	Finish	Matador	ØxH _{mm}
700062	clear	15"	Ø53 x 268
700084	clear	20"	Ø63 x 280
700095	satin	20"	Ø63 x 280

GLASSWARE FOR KEROSENE LAMPS

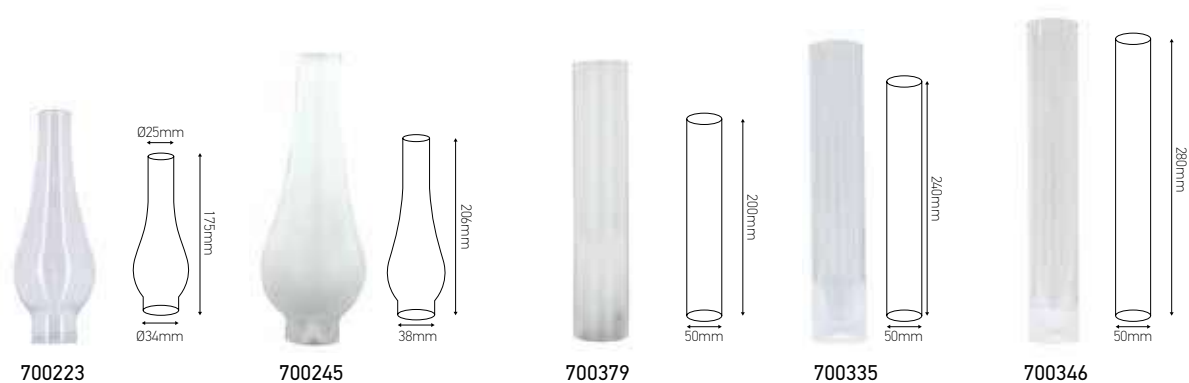

Ref.	Finish	Form	ØxH _{mm}
700223	clear	Convex "Viennois"	Ø34 x 175
700245	satin	Convex "Viennois"	Ø38 x 206
700379	satin	cylindrical glass	Ø50 x 200
700335	clear	cylindrical glass	Ø50 x 240
700346	clear	cylindrical glass	Ø50 x 280

GLASSWARE FOR KEROSENE LAMPS



Ref.	Finish	Form	ØxH _{mm}
700101	clear	pigeon	Ø33 x 92mm

GALLERY NIPPLE



289658

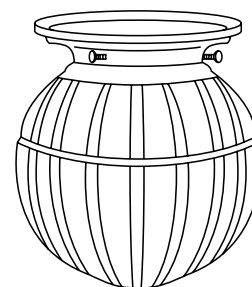

Ref.	Material	Thread	Dim. ØxH _{mm}
289658	chrome-plated brass	female 10x1	Ø85 x 27mm

LAMPSHADE GALLERIE 57mm



288525



288636

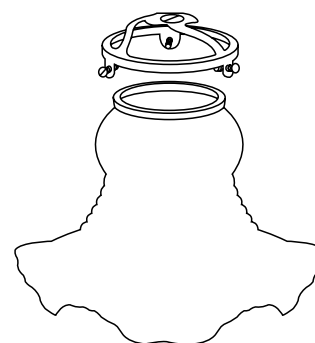

Ref.	Material	Hole Ø _{mm}	Height _{mm}
288525	brass	11	23
288636	brass	28	24.3

LAMPSHADE GALLERIE 85/100mm



288760



288869

Ref.	Material	Hole Ø _{mm}	Dim. ØxH _{mm}	
288760	varnished polished brass	11	85 x 29	5
288869	varnished polished brass	11	100 x 29	5

SHADE ADAPTOR FOR E27 LAMP HOLDER



289204

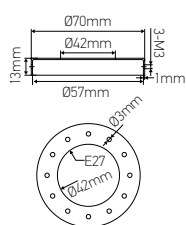

289205

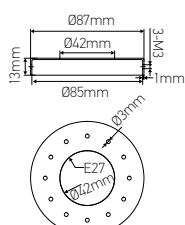

289206

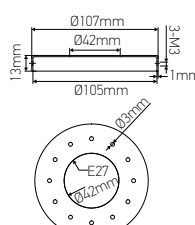

Ref.	Material	Hole Ø _{mm}	Dim. ØxH _{mm}	
289204	steel	42	70 x 13	10
289205	steel	42	87 x 13	10
289206	steel	42	107 x 13	10

Material | Steel

PIANO WIRE SPRING



290615

Ref.	Material	Hole Ø _{mm}	Length _{mm}
290615	steel	10.5	90



703012

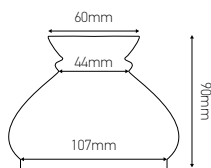

703023

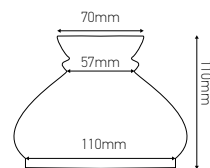

703034

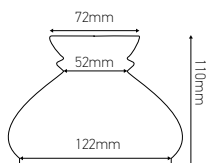

703045

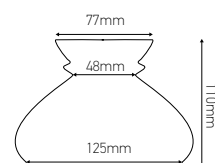

703059

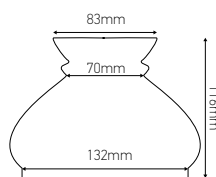

703060

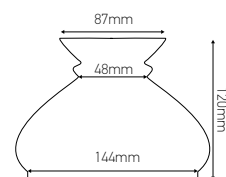

703072

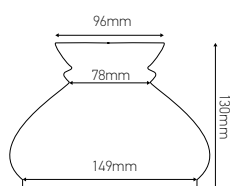

Ref.	Material	Finish	ØxH _{mm}
703012	glass	opal	Ø107 x 90
703023	glass	opal	Ø110 x 110
703034	glass	opal	Ø122 x 110
703045	glass	opal	Ø125 x 110
703059	glass	opal	Ø132 x 116
703060	glass	opal	Ø144 x 120
703072	glass	opal	Ø149 x 130



703096

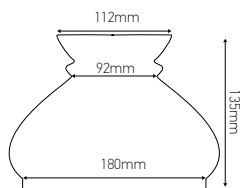

703107

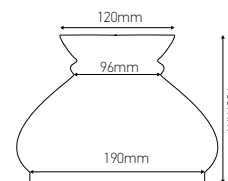

703120

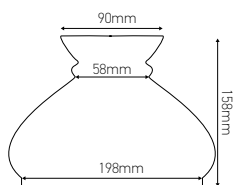

703186

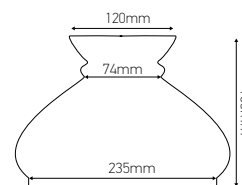

703325

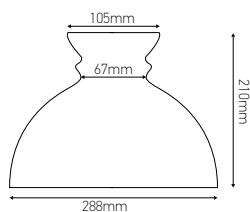

703336

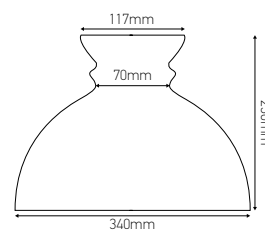

Ref.	Material	Finish	ØxH _{mm}
703096	glass	opal	Ø180 x 135
703107	glass	opal	Ø190 x 165
703120	glass	opal	Ø198 x 158
703186	glass	opal	Ø235 x 185
703325	glass	opal	Ø288 x 210
703336	glass	opal	Ø340 x 230

GLOBE GLASSWARE

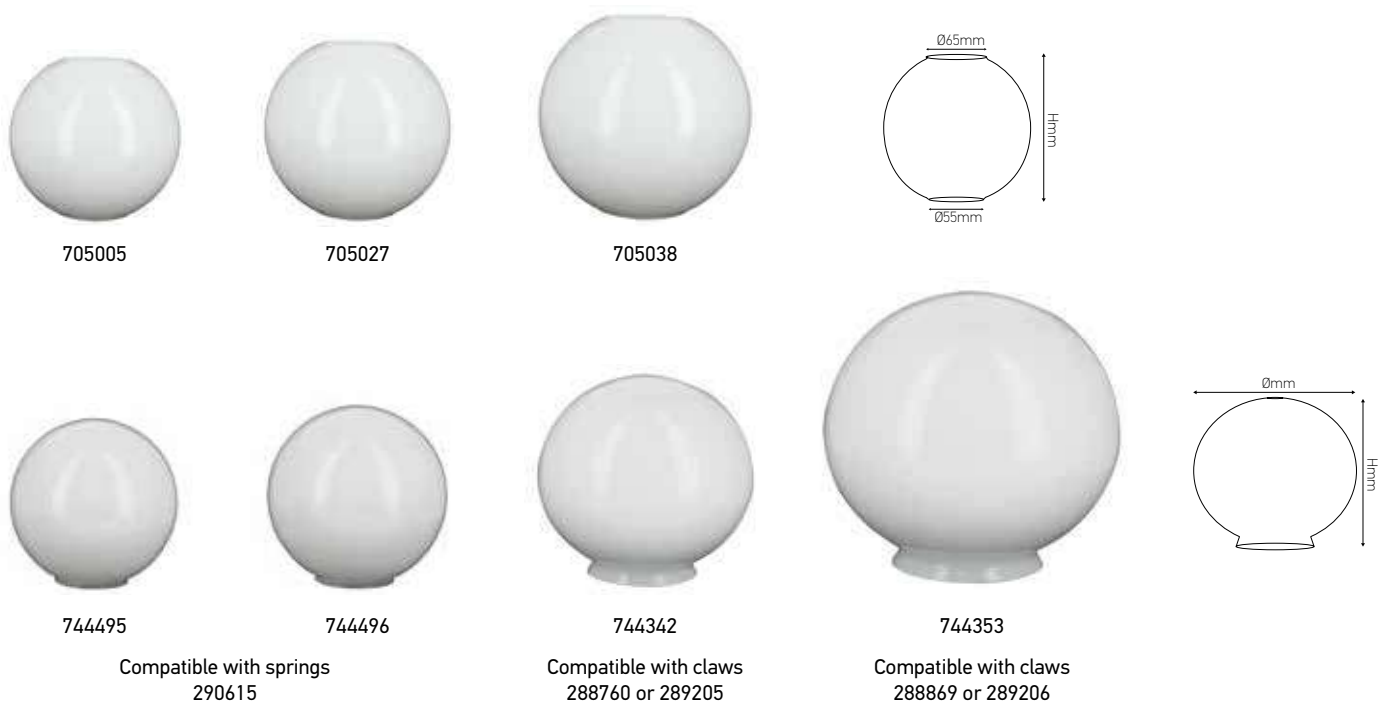

Ref.	Material	Finish	Collar mm	Top opening mm	Bottom opening mm	ØxHmm
705005	glass	opal	-	Ø65	Ø55	Ø130 x 115mm
705027	glass	opal	-	Ø65	Ø55	Ø150 x 137mm
705038	glass	opal	-	Ø65	Ø55	Ø180 x 160mm
744495	glass	opal	Ø50	-	Ø50	Ø100 x 100mm
744496	glass	opal	Ø50	-	Ø50	Ø120 x 120mm
744342	glass	opal	Ø85	-	-	Ø80 x 150mm
744353	glass	opal	Ø100	-	-	Ø200 x 200mm
744518	glass	mat	Ø40	-	-	Ø130 x 126mm
744529	glass	mat	Ø40	-	-	Ø150 x 150mm

"EPI" TULIP GLASSWARE VINTAGE STYLE



712069



715168

Ref.	Material	Finish	ØxH _{mm}
712069	glass	frosted - clear edge	Ø145 x 110
715168	glass	frosted - peach border	Ø145 x 110

Claws | 288525, 288636, 289204

TULIP FOR CHANDELIERS



744603



744624

Ref.	Material	Finish	Collar _{mm}	ØxH _{mm}
744603	glass	satin	Ø28	Ø103 x 80
744624	glass	satin	Ø28	Ø135 x 100

Button tulip - 5 petals - Satin glass

OPAL LAMPSHADES



730367



730502

Ref.	Material	Finish	ØxH _{mm}
730367	glass	opal	Ø250 x 55
730502	glass	opal	Ø230 x 112

Claws | 288525, 288636, 289204

ENGRAVED SATIN GLOBE "LOUIS XV" STYLE



705263

705274

705285

705296

Ref.	Material	Finish	Top opening mm	Bottom opening mm	ØxH _{mm}
705263	glass	satin opal	Ø65	Ø50	Ø130 x 115
705274	glass	satin opal	Ø65	Ø50	Ø150 x 137
705285	glass	satin opal	Ø65	Ø50	Ø180 x 160
705296	glass	satin opal	Ø65	Ø55	Ø200 x 195mm

ENGRAVED SATIN TULIP



706426



Ref.	Material	Finish	Collar mm	ØxH _{mm}
706426	glass	satin opal	Ø28	Ø90 x 115mm

TULIP GLASSWARE



710612



Ref.	Material	Finish	Collar mm	ØxH _{mm}
710612	glass	satin opal	Ø28	Ø90 x 115



“EMPIRE” STYLE FLAME GLASSWARE



713475

713488

713517

Ref.	Material	Finish	Claw	Claw mm	ØxHmm
713475	glass	satin opal	288525 / 288636	57	Ø90 x 125
713488	glass	satin opal	288760 / 289658 / 289205	80	Ø110 x 165
713517	glass	satin opal	288869 / 289206	100	Ø170 x 220

“ART DECO” STYLE TULIP GLASSWARE



714696

714663

Ref.	Material	Finish	Claw	Support	ØxHmm
714696	glass	transparent	-	E14 B22	Ø98 x 129
714663	glass	transparent	288525 / 288636	Claw Ø57mm	Ø107 x 136

187571
Lamp holder

289205
Claw

716999
Flame effect

713488
Glassware



TULIP FOR CHANDELIERS



745367



745480



745478



745490

Ref.	Finish	Collar mm	ØxHmm
745367	glossy amber glass	48	Ø117 x 130
745480	amber satin finish, clear engraving	50	Ø140 x 115
745478	satin finish, clear engraving	50	Ø130 x 135
745490	engraved satin finish, amber twisted rib edge	55	Ø117 x 130

ENGRAVED SATIN GLOBE FOR CHANDELIERS



745498



745500



745501

Ref.	Finish	Collar mm	ØxHmm
745498	satin finish, clear engraving	50	Ø120 x 120
745500	satin finish, clear engraving	50	Ø137 x 140
745501	amber luster, clear engraving	50	Ø120 x 130

TRANSPARENT GLASS CYLINDER FOR E14 LAMP HOLDER



710507

Ref.	Material	Finish	Collar mm	Lamp holder	ØxHmm
710507	glass	transparent	42	E27	Ø110 x 250

Glass lamp holder pendant with rings and mounts

ACCESSORY FOR KEROSENE LAMPS



700448



700761



700783

Ref.	Material	Description	LxW _{mm}
700448	polished brass	kosmos wick spout 14"	-
700761	-	14" fringed strand	200 x 64
700783	-	pigeon wick	140 x 5

NOZZLE FOR ELECTRIC KEROSENE LAMP



360301

Ref.	Material	ØxH _{mm}
360301	polished brass	Ø45 x 49

Gallery with base, welded key and foot for E14
Lamp holder - 14" caliber



CANDLE SLEEVE & CANDLES



CANDLE SLEEVE WITHOUT DRIPS	230
CANDLE SLEEVE WITH DRIPS.....	231
CANDLE HOLDERS E14.....	232
CANDLE "GRAND SIÈCLE" MODERN.....	235
CANDLE "VIVAFLAMME" E14.....	236

CANDLE SLEEVE WITHOUT DRIPS

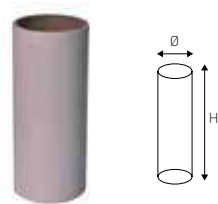

Ref.	Material	Color	For sheath lamp holder	ØxH _{mm}
200106	rigid cardboard	antique white	E14 - Ø22.5mm	Ø24 x 65
200107	rigid cardboard	antique white	E14 - Ø22.5mm	Ø24 x 70
200108	rigid cardboard	antique white	E14 - Ø22.5mm	Ø24 x 80
200109	rigid cardboard	antique white	E14 - Ø22.5mm	Ø24 x 85
200110	rigid cardboard	antique white	E14 - Ø22.5mm	Ø24 x 100
200112	rigid cardboard	antique white	E14 - Ø22.5mm	Ø24 x 120
200118	rigid cardboard	antique white	E14 - Ø22.5mm	Ø24 x 170
200121	rigid cardboard	antique white	E14 - Ø22.5mm	Ø24 x 230

2A
250V

T 135^{°C}

650°



EN 60238

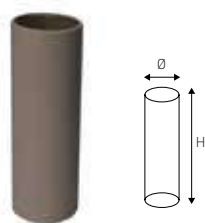

202041

Ref.	Material	Color	For sheath lamp holder	ØxH _{mm}
202041	rigid cardboard	antique white	E14 - Ø22.5mm	Ø27 x 70

CANDLE SLEEVE WITH DRIPS

650° |  10



200143

200216

200345

Ref.	Material	Color	For sheath lamp holder	ØxH _{mm}
200143	rigid cardboard	antique white	E14 - Ø22.5mm	Ø24 x 65
200145	rigid cardboard	antique white	E14 - Ø22.5mm	Ø24 x 70
200148	rigid cardboard	antique white	E14 - Ø22.5mm	Ø24 x 80
200151	rigid cardboard	antique white	E14 - Ø22.5mm	Ø24 x 85
200153	rigid cardboard	antique white	E14 - Ø22.5mm	Ø24 x 100
200216	rigid cardboard	antique ivory	E14 - Ø22.5mm	Ø24 x 65
200237	rigid cardboard	antique ivory	E14 - Ø22.5mm	Ø24 x 70
200248	rigid cardboard	antique ivory	E14 - Ø22.5mm	Ø24 x 80
200249	rigid cardboard	antique ivory	E14 - Ø22.5mm	Ø24 x 85
200250	rigid cardboard	antique ivory	E14 - Ø22.5mm	Ø24 x 100
200345	rigid cardboard	antique cardboard	E14 - Ø22.5mm	Ø24 x 65
200347	rigid cardboard	antique cardboard	E14 - Ø22.5mm	Ø24 x 70
200348	rigid cardboard	antique cardboard	E14 - Ø22.5mm	Ø24 x 80
200349	rigid cardboard	antique cardboard	E14 - Ø22.5mm	Ø24 x 85
200350	rigid cardboard	antique cardboard	E14 - Ø22.5mm	Ø24 x 100

Wax-coated cardboard

2A 250V | T 135°C | 650° |  10



202017

202019

202052

202074

202246

202259

Ref.	Material	Color	For sheath lamp holder	ØxH _{mm}
202017	rigid cardboard	antique cardboard	E14 - Ø26mm	Ø27 x 70
202019	rigid cardboard	antique cardboard	E14 - Ø26mm	Ø27 x 85
202052	rigid cardboard	antique white	E14 - Ø26mm	Ø27 x 70
202074	rigid cardboard	antique white	E14 - Ø26mm	Ø27 x 100
202246	rigid cardboard	antique ivory	E14 - Ø26mm	Ø27 x 70
202259	rigid cardboard	antique ivory	E14 - Ø26mm	Ø27 x 85

CANDLE HOLDER E14 FOR FEMALE 10x1

2A
250V

T 135^{°C}

650°



201047

201059

201062

Ref.	Material	Threaded	ØxH _{mm}
201047	thermoplastic	female 10 x 1	Ø23 x 65
201059	thermoplastic	female 10 x 1	Ø23 x 80
201062	thermoplastic	female 10 x 1	Ø23,5 x 100

Metal connector 10 x 1, stop screw

CANDLE HOLDER E14 FEMALE NOZZLES

2A
250V

T 135^{°C}

650°



201072

201084

201096

Ref.	Material	Threaded	ØxH _{mm}
201072	thermosetting insulation	metal connector 10 x 1	Ø23,5 x 65
201084	thermosetting insulation	metal connector 10 x 1	Ø23,5 x 85
201096	thermosetting insulation	metal connector 10 x 1	Ø23,5 x 100





CANDLE "GRAND SIÈCLE" MODERN

EN 60598



205727

205743

Ref.	Color	For sheath lamp holder	ØxH _{mm}
205727	satin ivory	E14	Ø22 x 170
205743	satin ivory	E14	Ø22 x 230

Registered model
Cylindrical candle without heel
not wired



206850

206877

206893

Ref.	Color	For sheath lamp holder	ØxH _{mm}
206850	satin ivory	E10	Ø22 x 110
206877	satin ivory	E10	Ø22 x 170
206893	satin ivory	E10	Ø22 x 230

Registered model
Taper candle
not wired
Registered model
Delivered unassembled. Connection terminal integrated into the double hull
Direct connection of the double insulation cable of the luminaire to this terminal block

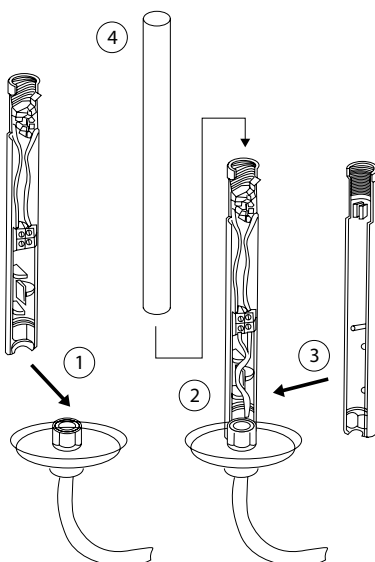

ELECTRONIC CANDLE “VIVAFLAMME” E14



0.3W
Max.



Ra
≥85



1



204633

3W lamp with plastic counterweight
Compatible with reference 204637
Voltage | 230V AC +/- 10%
Compatible only with the references below
Size | Ø19.5 x 102mm



204637

Compatible with the 3W lamp reference 204633
Color of light | Super warm white LED 2000K.
Cannot be used with a dimmer
Periodic movement of the light source every - 30 to 40 seconds
The light source is replaceable
Voltage | 230V AC +/- 10%
Size | Ø23.4 x 200mm



204633

+



204637

+



204638
23,4 x 200mm

⇒



204639



Summary of references

Ref.	CATALOG	PAGE	EAN
11520	SOURCES	150	3125460115204
11530	SOURCES	150	3125460115303
13200	SOURCES	154	3125460132003
13230	SOURCES	154	3125460132300
14110	SOURCES	154	3125460141104
14400	SOURCES	153	3125460144006
14510	SOURCES	153	3125460145102
14621	SOURCES	141	3125460146215
15646	SOURCES	62	3125460156467
15647	SOURCES	62	3125460156474
15648	SOURCES	62	3125460156481
15649	SOURCES	63	3125460156498
15651	SOURCES	62	3125460156511
15652	SOURCES	62	3125460156528
15653	SOURCES	62	3125460156535
15654	SOURCES	63	3125460156542
15655	SOURCES	62	3125460156559
15656	SOURCES	62	3125460156566
15658	SOURCES	63	3125460156580
15900	SOURCES	152	3125460159000
16001	SOURCES	57	3125460160013
16003	SOURCES	57	3125460160037
16005	SOURCES	57	3125460160051
16007	SOURCES	57	3125460160075
16011	SOURCES	57	3125460160112
16015	SOURCES	57	3125460160150
16017	SOURCES	57	3125460160174
16021	SOURCES	61	3125460160211
16022	SOURCES	61	3125460160228
16023	SOURCES	61	3125460160235
16024	SOURCES	61	3125460160242
16026	SOURCES	61	3125460160266
16027	SOURCES	61	3125460160273
18455	SOURCES	41	3125460184552
18461	SOURCES	41	3125460184613
18462	SOURCES	40	3125460184620
18464	SOURCES	141	3125460184644
18467	SOURCES	39	3125460184675
18471	ACCESSORIES	32	3125460184712
18473	SOURCES	141	3125460184736
18474	SOURCES	39	3125460184743
18476	SOURCES	39	3125460184767
18477	SOURCES	141	3125460184774
21000	LUMINAIRES	76	3125460210008
21001	LUMINAIRES	76	3125460210015
21002	LUMINAIRES	76	3125460210022
21003	LUMINAIRES	76	3125460210039
21004	LUMINAIRES	76	3125460210046
24976	SOURCES	116	3125460249763

New

New

Ref.	CATALOG	PAGE	EAN
24977	SOURCES	116	3125460249770
24978	SOURCES	116	3125460249787
24980	SOURCES	117	3125460249800
24990	SOURCES	115	3125460249909
24992	SOURCES	115	3125460249923
24993	SOURCES	114	3125460249930
24994	SOURCES	115	3125460249947
24996	SOURCES	115	3125460249961
24998	SOURCES	114	3125460249985
28623	SOURCES	96	3125460286232
28625	SOURCES	96	3125460286256
28626	SOURCES	96	3125460286263
28627	SOURCES	96	3125460286270
28631	SOURCES	96	3125460286317
28633	SOURCES	96	3125460286331
28639	SOURCES	96	3125460286393
28646	SOURCES	90	3125460286461
28647	SOURCES	90	3125460286478
28648	SOURCES	90	3125460286485
28649	SOURCES	90	3125460286492
28652	SOURCES	96	3125460286522
28653	SOURCES	96	3125460286539
28656	SOURCES	96	3125460286560
28658	SOURCES	90	3125460286584
28659	SOURCES	90	3125460286591
28660	SOURCES	96	3125460286607
28662	SOURCES	96	3125460286621
28664	SOURCES	96	3125460286645
28665	SOURCES	90	3125460286652
28666	SOURCES	90	3125460286669
28670	SOURCES	90	3125460286706
28671	SOURCES	90	3125460286713
28672	SOURCES	90	3125460286720
28673	SOURCES	90	3125460286737
28674	SOURCES	96	3125460286744
28675	SOURCES	96	3125460286751
28676	SOURCES	96	3125460286768
28677	SOURCES	96	3125460286775
28681	SOURCES	90	3125460286812
30100	LUMINAIRES	131	3125460301003
30101	LUMINAIRES	131	3125460301010
30102	LUMINAIRES	131	3125460301027
30103	LUMINAIRES	131	3125460301034
30104	LUMINAIRES	131	3125460301041
30105	LUMINAIRES	131	3125460301058
30106	LUMINAIRES	131	3125460301065
30107	LUMINAIRES	131	3125460301072
30108	LUMINAIRES	132	3125460301089
30109	LUMINAIRES	132	3125460301096

Ref.	CATALOG	PAGE	EAN
30110	LUMINAIRES	132	3125460301102
30111	LUMINAIRES	132	3125460301119
30112	LUMINAIRES	132	3125460301126
30113	LUMINAIRES	132	3125460301133
30114	LUMINAIRES	132	3125460301140
30115	LUMINAIRES	132	3125460301157
30116	LUMINAIRES	131	3125460301164
30117	LUMINAIRES	131	3125460301171
30118	LUMINAIRES	131	3125460301188
30119	LUMINAIRES	131	3125460301195
30120	LUMINAIRES	131	3125460301201
30121	LUMINAIRES	131	3125460301218
30122	LUMINAIRES	132	3125460301225
30123	LUMINAIRES	132	3125460301232
30124	LUMINAIRES	132	3125460301249
30125	LUMINAIRES	132	3125460301256
30126	LUMINAIRES	132	3125460301263
30127	LUMINAIRES	132	3125460301270
30128	LUMINAIRES	133	3125460301287
30129	LUMINAIRES	133	3125460301294
30130	LUMINAIRES	133	3125460301300
30131	LUMINAIRES	133	3125460301317
30132	LUMINAIRES	133	3125460301324
30133	LUMINAIRES	133	3125460301331
30134	LUMINAIRES	133	3125460301348
30135	LUMINAIRES	133	3125460301355
30136	LUMINAIRES	133	3125460301362
30137	LUMINAIRES	133	3125460301379
30138	LUMINAIRES	133	3125460301386
30139	LUMINAIRES	133	3125460301393
30140	LUMINAIRES	133	3125460301409
30141	LUMINAIRES	133	3125460301416
30142	LUMINAIRES	133	3125460301423
30143	LUMINAIRES	133	3125460301430
30144	LUMINAIRES	133	3125460301447
30145	LUMINAIRES	133	3125460301454
30146	LUMINAIRES	133	3125460301461
30147	LUMINAIRES	133	3125460301478
30148	LUMINAIRES	133	3125460301485
30149	LUMINAIRES	133	3125460301492
30150	LUMINAIRES	133	3125460301508
30151	LUMINAIRES	133	3125460301515
30152	LUMINAIRES	133	3125460301522
30160	LUMINAIRES	134	3125460301607
30161	LUMINAIRES	134	3125460301614
30162	LUMINAIRES	134	3125460301621
30163	LUMINAIRES	134	3125460301638
30164	LUMINAIRES	134	3125460301645
30165	LUMINAIRES	134	3125460301652

Ref.	CATALOG	PAGE	EAN
30166	LUMINAIRES	134	3125460301669
30167	LUMINAIRES	134	3125460301676
30168	LUMINAIRES	134	3125460301683
30169	LUMINAIRES	134	3125460301690
30170	LUMINAIRES	134	3125460301706
30171	LUMINAIRES	134	3125460301713
30172	LUMINAIRES	135	3125460301720
30173	LUMINAIRES	135	3125460301737
30174	LUMINAIRES	135	3125460301744
30175	LUMINAIRES	135	3125460301751
30176	LUMINAIRES	135	3125460301768
30177	LUMINAIRES	135	3125460301775
30178	LUMINAIRES	135	3125460301782
30179	LUMINAIRES	135	3125460301799
30180	LUMINAIRES	118	3125460301805
30181	LUMINAIRES	118	3125460301812
30182	LUMINAIRES	118	3125460301829
30183	LUMINAIRES	118	3125460301836
30200	LUMINAIRES	136	3125460302000
30201	LUMINAIRES	136	3125460302017
30202	LUMINAIRES	136	3125460302024
30203	LUMINAIRES	136	3125460302031
30204	LUMINAIRES	136	3125460302048
30205	LUMINAIRES	136	3125460302055
30206	LUMINAIRES	136	3125460302062
30207	LUMINAIRES	136	3125460302079
30208	LUMINAIRES	137	3125460302086
30209	LUMINAIRES	137	3125460302093
30210	LUMINAIRES	137	3125460302109
30211	LUMINAIRES	137	3125460302116
30212	LUMINAIRES	137	3125460302123
30213	LUMINAIRES	137	3125460302130
30214	LUMINAIRES	137	3125460302147
30215	LUMINAIRES	137	3125460302154
30216	LUMINAIRES	137	3125460302161
30217	LUMINAIRES	137	3125460302178
30218	LUMINAIRES	137	3125460302185
30219	LUMINAIRES	137	3125460302192
30220	LUMINAIRES	137	3125460302208
30221	LUMINAIRES	137	3125460302215
30222	LUMINAIRES	137	3125460302222
30223	LUMINAIRES	137	3125460302239
130601	SOURCES	139	3125461306014
130602	SOURCES	139	3125461306021
130603	SOURCES	139	3125461306038
130604	SOURCES	139	3125461306045
142529	ACCESSORIES	195	3125461425296
142693	ACCESSORIES	116	3125461426934
153373	ACCESSORIES	122	3125461533731

New
New
New
New

New
New
New
New

Ref.	CATALOG	PAGE	EAN
155463	ACCESSORIES	156	3125461554637
155559	LUMINAIRES	105	3125461555597
155560	LUMINAIRES	102	3125461555603
155561	LUMINAIRES	105	3125461555610
155564	LUMINAIRES	102	3125461555641
155566	LUMINAIRES	102	3125461555665
155567	LUMINAIRES	105	3125461555672
155569	LUMINAIRES	107	3125461555696
155570	LUMINAIRES	56	3125461555702
155731	ACCESSORIES	156	3125461557317
155733	ACCESSORIES	156	3125461557331
155735	ACCESSORIES	156	3125461557355
155736	ACCESSORIES	157	3125461557362
155737	ACCESSORIES	157	3125461557379
155738	ACCESSORIES	157	3125461557386
157163	ACCESSORIES	120	3125461571634
158009	LUMINAIRES	170	3125461580094
158011	LUMINAIRES	170	3125461580117
158014	LUMINAIRES	170	3125461580148
158016	LUMINAIRES	170	3125461580162
158018	SOURCES	80	3125461580186
158018	LUMINAIRES	172	3125461580186
158019	SOURCES	80	3125461580193
158019	LUMINAIRES	172	3125461580193
158020	SOURCES	80	3125461580209
158020	LUMINAIRES	172	3125461580209
158022	SOURCES	80	3125461580223
158022	LUMINAIRES	172	3125461580223
158063	ACCESSORIES	92	3125461580636
158206	LUMINAIRES	101	3125461582067
158265	ACCESSORIES	126	3125461582654
158267	ACCESSORIES	126	3125461582678
158269	ACCESSORIES	126	3125461582692
158339	LUMINAIRES	101	3125461583392
158459	ACCESSORIES	126	3125461584597
158481	LUMINAIRES	106	3125461584818
158461	ACCESSORIES	126	3125461584610
158482	LUMINAIRES	106	3125461584825
158463	ACCESSORIES	126	3125461584634
158484	LUMINAIRES	106	3125461584849
158485	LUMINAIRES	107	3125461584856
158465	ACCESSORIES	126	3125461584658
158487	LUMINAIRES	107	3125461584870
158495	LUMINAIRES	56	3125461584955
158530	ACCESSORIES	126	3125461585303
158531	ACCESSORIES	126	3125461585310
158532	ACCESSORIES	127	3125461585327
158705	ACCESSORIES	171	3125461587055
158844	LUMINAIRES	114	3125461588441

+
+

+

+

+

+

+

+

+

Ref.	CATALOG	PAGE	EAN
158852	ACCESSORIES	164	3125461588526
158858	ACCESSORIES	165	3125461588588
158860	ACCESSORIES	164	3125461588601
158872	ACCESSORIES	28	3125461588724
158879	LUMINAIRES	145	3125461588793
158880	LUMINAIRES	145	3125461588809
160099	SOURCES	123	3125461600990
160101	SOURCES	124	3125461601010
160102	SOURCES	124	3125461601027
160103	SOURCES	123	3125461601034
160104	SOURCES	122	3125461601041
160105	SOURCES	122	3125461601058
160114	SOURCES	124	3125461601140
160115	SOURCES	123	3125461601157
160117	SOURCES	123	3125461601171
160122	SOURCES	128	3125461601225
160124	SOURCES	128	3125461601249
160134	SOURCES	123	3125461601348
160152	SOURCES	128	3125461601522
160171	SOURCES	128	3125461601713
160173	SOURCES	124	3125461601737
160192	SOURCES	123	3125461601928
160194	SOURCES	122	3125461601942
160198	SOURCES	123	3125461601980
160200	SOURCES	123	3125461602000
160203	SOURCES	129	3125461602031
160204	SOURCES	129	3125461602048
160205	SOURCES	128	3125461602055
160211	SOURCES	134	3125461602116
160212	SOURCES	134	3125461602123
161152	LUMINAIRES	84	3125461611521
161153	LUMINAIRES	84	3125461611538
161154	LUMINAIRES	84	3125461611545
161156	SOURCES	136	3125461611569
161158	LUMINAIRES	84	3125461611583
161159	LUMINAIRES	84	3125461611590
161162	LUMINAIRES	86	3125461611620
161163	SOURCES	136	3125461611637
161164	LUMINAIRES	86	3125461611644
161165	SOURCES	136	3125461611651
161166	LUMINAIRES	87	3125461611668
161167	LUMINAIRES	87	3125461611675
161168	LUMINAIRES	86	3125461611682
161169	LUMINAIRES	87	3125461611699
161170	LUMINAIRES	86	3125461611705
161171	SOURCES	136	3125461611712
161173	SOURCES	136	3125461611736
161174	LUMINAIRES	87	3125461611743
161175	LUMINAIRES	86	3125461611750

New

Summary of references

Ref.	CATALOG	PAGE	EAN
161176	LUMINAIRES	86	3125461611767
161177	LUMINAIRES	86	3125461611774
161178	LUMINAIRES	86	3125461611781
161179	LUMINAIRES	87	3125461611798
161180	LUMINAIRES	154	3125461611804
161181	LUMINAIRES	154	3125461611811
161182	LUMINAIRES	154	3125461611828
161183	LUMINAIRES	154	3125461611835
161184	LUMINAIRES	154	3125461611842
161185	LUMINAIRES	87	3125461611859
161186	LUMINAIRES	87	3125461611866
161187	LUMINAIRES	154	3125461611873
161188	LUMINAIRES	87	3125461611880
161189	LUMINAIRES	86	3125461611897
161190	LUMINAIRES	87	3125461611903
161191	LUMINAIRES	86	3125461611910
161192	LUMINAIRES	87	3125461611927
161193	SOURCES	133	3125461611934
161194	SOURCES	133	3125461611941
161195	LUMINAIRES	86	3125461611958
161196	LUMINAIRES	87	3125461611965
161197	LUMINAIRES	86	3125461611972
161198	LUMINAIRES	87	3125461611989
161199	LUMINAIRES	86	3125461611996
161200	LUMINAIRES	87	3125461612009
161201	LUMINAIRES	84	3125461612016
161202	LUMINAIRES	84	3125461612023
161203	SOURCES	136	3125461612030
161204	SOURCES	136	3125461612047
161205	SOURCES	137	3125461612054
161206	SOURCES	137	3125461612061
161207	SOURCES	137	3125461612078
161208	SOURCES	139	3125461612085
161209	SOURCES	136	3125461612092
162027	LUMINAIRES	74	3125461620271
162040	SOURCES	81	3125461620400
162040	LUMINAIRES	173	3125461620400
162047	LUMINAIRES	73	3125461620479
163065	SOURCES	165	7640153464637
163071	SOURCES	166	7640153464699
163131	SOURCES	147	7640153468192
163132	SOURCES	147	7640153468208
163143	SOURCES	146	7640153468314
163145	SOURCES	146	7640153468338
163206	SOURCES	131	3125461632069
163348	LUMINAIRES	140	3125461633486
163349	LUMINAIRES	140	3125461633493
163352	LUMINAIRES	140	3125461633523
163353	LUMINAIRES	140	3125461633530

New
New
New
New
New

Ref.	CATALOG	PAGE	EAN
163354	LUMINAIRES	140	3125461633547
164118	SOURCES	72	3125461641184
164403	LUMINAIRES	109	3125461644031
164404	LUMINAIRES	109	3125461644048
164405	LUMINAIRES	109	3125461644055
164406	LUMINAIRES	111	3125461644062
164407	LUMINAIRES	109	3125461644079
164408	LUMINAIRES	109	3125461644086
164409	LUMINAIRES	109	3125461644093
164410	LUMINAIRES	111	3125461644109
164411	LUMINAIRES	111	3125461644116
164421	LUMINAIRES	109	3125461644215
164422	LUMINAIRES	109	3125461644222
164423	LUMINAIRES	109	3125461644239
164435	LUMINAIRES	110	3125461644352
164436	LUMINAIRES	110	3125461644369
164437	LUMINAIRES	110	3125461644376
164441	LUMINAIRES	111	3125461644413
164450	LUMINAIRES	110	3125461644505
164451	LUMINAIRES	110	3125461644512
164452	LUMINAIRES	110	3125461644529
164465	LUMINAIRES	110	3125461644659
164466	LUMINAIRES	110	3125461644666
164467	LUMINAIRES	110	3125461644673
164543	LUMINAIRES	183	3125461645434
164809	LUMINAIRES	115	3125461648091
164811	LUMINAIRES	115	3125461648114
164812	LUMINAIRES	115	3125461648121
164918	SOURCES	131	3125461649180
164931	SOURCES	129	3125461649319
164932	SOURCES	129	3125461649326
165408	LUMINAIRES	104	3125461654085
165409	LUMINAIRES	104	3125461654092
165423	LUMINAIRES	101	3125461654238
165424	LUMINAIRES	104	3125461654245
165425	LUMINAIRES	98	3125461654252
165456	SOURCES	96	3125461654566
165457	SOURCES	96	3125461654573
165458	SOURCES	90	3125461654580
165461	SOURCES	90	3125461654610
165462	SOURCES	96	3125461654627
165463	SOURCES	91	3125461654634
165470	LUMINAIRES	182	3125461654702
165471	LUMINAIRES	182	3125461654719
166051	SOURCES	128	3125461660512
166052	SOURCES	131	3125461660529
166062	SOURCES	128	3125461660628
166063	SOURCES	131	3125461660635
166096	SOURCES	134	3125461660963

+
+
+
+

Ref.	CATALOG	PAGE	EAN
166097	SOURCES	134	3125461660970
166098	SOURCES	134	3125461660987
166099	SOURCES	134	3125461660994
166103	LUMINAIRES	69	3125461661038
166104	LUMINAIRES	69	31254 616 61045
166106	LUMINAIRES	69	3125461661069
166300	LUMINAIRES	68	3125461663001
166301	LUMINAIRES	68	3125461663018
166302	LUMINAIRES	68	3125461663025
167029	LUMINAIRES	99	3125461670290
167030	LUMINAIRES	99	3125461670306
167036	LUMINAIRES	100	3125461670368
167037	LUMINAIRES	100	3125461670375
167056	LUMINAIRES	100	3125461670566
167057	LUMINAIRES	99	3125461670573
167058	LUMINAIRES	99	3125461670580
167089	LUMINAIRES	99	3125461670894
167090	LUMINAIRES	99	3125461670900
167113	LUMINAIRES	98	3125461671136
167114	LUMINAIRES	98	3125461671143
167138	SOURCES	123	3125461671389
167139	SOURCES	123	3125461671396
167140	SOURCES	123	3125461671402
167183	SOURCES	135	3125461671839
167184	SOURCES	135	3125461671846
167185	SOURCES	135	3125461671853
167186	SOURCES	135	3125461671860
167187	SOURCES	135	3125461671877
167188	SOURCES	135	3125461671884
167193	SOURCES	122	3125461671938
167194	SOURCES	122	3125461671945
167195	SOURCES	122	3125461671952
167196	SOURCES	122	3125461671969
167197	SOURCES	123	3125461671976
167212	SOURCES	121	3125461672126
167222	SOURCES	121	3125461672225
167225	LUMINAIRES	60	3125461672256
167282	SOURCES	137	3125461672829
167288	SOURCES	137	3125461672881
167295	LUMINAIRES	62	3125461672959
167297	LUMINAIRES	62	3125461672973
167301	LUMINAIRES	77	3125461673017
167303	LUMINAIRES	77	3125461673031
167339	LUMINAIRES	52	3125461673390
167344	LUMINAIRES	52	3125461673444
167347	LUMINAIRES	73	3125461673475
167370	SOURCES	167	3125461673703
167377	LUMINAIRES	57	3125461673772
167379	LUMINAIRES	57	3125461673796

New
New
New
+
+
+
+

Ref.	CATALOG	PAGE	EAN		Ref.	CATALOG	PAGE	EAN		Ref.	CATALOG	PAGE	EAN	
167380	LUMINAIRES	57	3125461673802	+	168987	LUMINAIRES	149	3125461689872		169238	LUMINAIRES	130	3125461692384	+
167382	LUMINAIRES	57	3125461673826		168988	LUMINAIRES	149	3125461689889		169340	LUMINAIRES	53	3125461693404	
167384	LUMINAIRES	57	3125461673840		168990	LUMINAIRES	61	3125461689902		169342	LUMINAIRES	53	3125461693428	
167385	LUMINAIRES	57	3125461673857		168991	LUMINAIRES	61	3125461689919		169366	LUMINAIRES	52	3125461693664	
167386	LUMINAIRES	57	3125461673864		168992	LUMINAIRES	61	3125461689926		169388	LUMINAIRES	50	3125461693886	
167387	LUMINAIRES	57	3125461673871		168993	LUMINAIRES	61	3125461689933		169399	LUMINAIRES	50	3125461693992	
167389	LUMINAIRES	57	3125461673895		169006	LUMINAIRES	74	3125461690069		169400	LUMINAIRES	50	3125461694005	
167390	LUMINAIRES	57	3125461673901	+	169111	LUMINAIRES	56	3125461691110	+	169404	LUMINAIRES	70	3125461694043	
167400	LUMINAIRES	71	3125461674007		169113	LUMINAIRES	56	3125461691134	+	169405	LUMINAIRES	160	3125461694050	
167414	LUMINAIRES	156	3125461674144		169143	LUMINAIRES	95	3125461691431		169406	LUMINAIRES	70	3125461694067	
167416	LUMINAIRES	165	3125461674168		169144	LUMINAIRES	95	3125461691448		169407	LUMINAIRES	160	3125461694074	
167438	ACCESSORIES	198	3125461674380		169145	LUMINAIRES	95	3125461691455		169408	LUMINAIRES	161	3125461694081	
167509	LUMINAIRES	71	3125461675097		169147	LUMINAIRES	83	3125461691479		169409	LUMINAIRES	161	3125461694098	
167510	ACCESSORIES	53	3125461675103		169148	LUMINAIRES	83	3125461691486		169410	LUMINAIRES	159	3125461694104	
167511	ACCESSORIES	53	3125461675110		169166	LUMINAIRES	92	3125461691660		169411	LUMINAIRES	159	3125461694111	
167512	ACCESSORIES	53	3125461675127		169167	LUMINAIRES	92	3125461691677		169412	LUMINAIRES	159	3125461694128	
167513	ACCESSORIES	53	3125461675134		169168	LUMINAIRES	92	3125461691684		169413	LUMINAIRES	159	3125461694135	
167518	ACCESSORIES	57	3125461675189		169170	LUMINAIRES	62	3125461691707	+	169436	LUMINAIRES	127	3125461694364	+
167519	ACCESSORIES	57	3125461675196		169171	LUMINAIRES	62	3125461691714	+	169444	LUMINAIRES	75	3125461694449	
167539	SOURCES	122	3125461675394		169173	LUMINAIRES	62	3125461691738	+	169445	LUMINAIRES	75	3125461694456	
167540	SOURCES	123	3125461675400		169177	LUMINAIRES	185	3125461691776		169500	LUMINAIRES	125	3125461695002	+
167541	SOURCES	123	3125461675417		169178	LUMINAIRES	185	3125461691783		169501	LUMINAIRES	127	3125461695019	+
167544	SOURCES	122	3125461675448		169193	LUMINAIRES	54	3125461691936		169502	LUMINAIRES	127	3125461695026	+
167545	SOURCES	123	3125461675455		169194	LUMINAIRES	54	3125461691943		169503	LUMINAIRES	126	3125461695033	+
167550	SOURCES	124	3125461675509		169198	LUMINAIRES	60	3125461691981	New	169504	LUMINAIRES	127	3125461695040	+
167552	SOURCES	123	3125461675523		169208	LUMINAIRES	81	3125461692087	New	169505	LUMINAIRES	126	3125461695057	+
167554	SOURCES	123	3125461675547		169209	LUMINAIRES	81	3125461692094	New	169506	LUMINAIRES	125	3125461695064	+
167558	SOURCES	123	3125461675585		169210	LUMINAIRES	82	3125461692100	New	169507	LUMINAIRES	126	3125461695071	+
168170	LUMINAIRES	62	3125461681708	+	169211	LUMINAIRES	82	3125461692117	New	169508	LUMINAIRES	126	3125461695088	+
168171	LUMINAIRES	62	3125461681715	+	169212	LUMINAIRES	82	3125461692124	New	169509	LUMINAIRES	126	3125461695095	+
168172	LUMINAIRES	63	3125461681722	+	169213	LUMINAIRES	82	3125461692131	New	169510	LUMINAIRES	125	3125461695101	+
168173	LUMINAIRES	63	3125461681739	+	169214	LUMINAIRES	81	3125461692148	New	169511	LUMINAIRES	125	3125461695118	+
168174	LUMINAIRES	64	3125461681746	+	169215	LUMINAIRES	81	3125461692155	New	169603	LUMINAIRES	124	3125461696030	New
168175	LUMINAIRES	64	3125461681753	+	169216	LUMINAIRES	81	3125461692162	New	169604	LUMINAIRES	124	3125461696047	New
168176	LUMINAIRES	64	3125461681760	+	169217	LUMINAIRES	81	3125461692179	New	169605	LUMINAIRES	80	3125461696054	New
168868	LUMINAIRES	71	3125461688684		169218	LUMINAIRES	81	3125461692186	New	169606	LUMINAIRES	80	3125461696061	New
168885	LUMINAIRES	157	3125461688851		169219	LUMINAIRES	81	3125461692193	New	169607	LUMINAIRES	148	3125461696078	New
168886	LUMINAIRES	157	3125461688868		169222	LUMINAIRES	92	3125461692223		169608	LUMINAIRES	148	3125461696085	New
168887	LUMINAIRES	157	3125461688875		169223	LUMINAIRES	95	3125461692230		169621	LUMINAIRES	121	3125461696214	New
168888	LUMINAIRES	157	3125461688882		169224	LUMINAIRES	129	3125461692247	+	169622	LUMINAIRES	121	3125461696221	New
168889	LUMINAIRES	158	3125461688899		169225	LUMINAIRES	129	3125461692254	+	169623	LUMINAIRES	121	3125461696238	New
168890	LUMINAIRES	158	3125461688905		169226	LUMINAIRES	129	3125461692261	+	169624	LUMINAIRES	120	3125461696245	New
168895	LUMINAIRES	162	3125461688950		169227	LUMINAIRES	129	3125461692278	+	169625	LUMINAIRES	120	3125461696252	New
168896	LUMINAIRES	162	3125461688967		169228	LUMINAIRES	130	3125461692285	+	169626	LUMINAIRES	120	3125461696269	New
168900	LUMINAIRES	163	3125461689001		169229	LUMINAIRES	130	3125461692292	+	169627	LUMINAIRES	120	3125461696276	New
168901	LUMINAIRES	164	3125461689018		169233	LUMINAIRES	130	3125461692339	+	169628	LUMINAIRES	120	3125461696283	New
168905	LUMINAIRES	162	3125461689056		169235	LUMINAIRES	128	3125461692353	+	169629	LUMINAIRES	120	3125461696290	New
168907	LUMINAIRES	162	3125461689070		169236	LUMINAIRES	128	3125461692360	+	169630	LUMINAIRES	120	3125461696306	New
168973	LUMINAIRES	150	3125461689735		169237	LUMINAIRES	128	3125461692377	+	169631	LUMINAIRES	120	3125461696313	New

Summary of references

Ref.	CATALOG	PAGE	EAN		Ref.	CATALOG	PAGE	EAN		Ref.	CATALOG	PAGE	EAN
169636	LUMINAIRES	122	3125461696368	New	174161	ACCESSORIES	64	3125461741617		187562	ACCESSORIES	57	3125461875626
169637	LUMINAIRES	122	3125461696375	New	174162	ACCESSORIES	64	3125461741624		187563	ACCESSORIES	63	3125461875633
169638	LUMINAIRES	122	3125461696382	New	174200	SOURCES	36	3125461742003	New	187564	ACCESSORIES	95	3125461875640
169639	LUMINAIRES	122	3125461696399	New	174201	SOURCES	36	3125461742010	New	187568	ACCESSORIES	96	3125461875688
169640	LUMINAIRES	123	3125461696405	New	174202	SOURCES	36	3125461742027	New	187569	ACCESSORIES	96	3125461875695
169641	LUMINAIRES	123	3125461696412	New	174203	SOURCES	36	3125461742034	New	187570	ACCESSORIES	96	3125461875701
169642	LUMINAIRES	123	3125461696429	New	174204	SOURCES	40	3125461742041	New	187571	ACCESSORIES	96	3125461875718
169643	LUMINAIRES	123	3125461696436	New	174300	SOURCES	36	3125461743000	New	187572	ACCESSORIES	76	3125461875725
169644	LUMINAIRES	119	3125461696443	New	174301	SOURCES	36	3125461743017	New	187573	ACCESSORIES	76	3125461875732
169645	LUMINAIRES	119	3125461696450	New	174302	SOURCES	36	3125461743024	New	187574	ACCESSORIES	80	3125461875749
169646	LUMINAIRES	119	3125461696467	New	187515	ACCESSORIES	60	3125461875152		187575	ACCESSORIES	80	3125461875756
169647	LUMINAIRES	119	3125461696474	New	187516	ACCESSORIES	60	3125461875169		187576	ACCESSORIES	80	3125461875763
169648	LUMINAIRES	119	3125461696481	New	187517	ACCESSORIES	60	3125461875176		187577	ACCESSORIES	80	3125461875770
169649	LUMINAIRES	119	3125461696498	New	187518	ACCESSORIES	74	3125461875183		187578	ACCESSORIES	80	3125461875787
169664	LUMINAIRES	166	3125461696641	New	187519	ACCESSORIES	74	3125461875190		187580	ACCESSORIES	131	3125461875800
169665	LUMINAIRES	166	3125461696658	New	187520	ACCESSORIES	74	3125461875206		187581	ACCESSORIES	131	3125461875817
169666	LUMINAIRES	166	3125461696665	New	187521	ACCESSORIES	74	3125461875213		187582	ACCESSORIES	131	3125461875824
169667	LUMINAIRES	166	3125461696672	New	187522	ACCESSORIES	76	3125461875220		187584	ACCESSORIES	45	3125461875848
169668	LUMINAIRES	166	3125461696689	New	187523	ACCESSORIES	76	3125461875237		187585	ACCESSORIES	62	3125461875855
169669	LUMINAIRES	166	3125461696696	New	187524	ACCESSORIES	76	3125461875244		187586	ACCESSORIES	45	3125461875862
169705	LUMINAIRES	80	3125461697051	New	187525	ACCESSORIES	78	3125461875251		187588	ACCESSORIES	43	3125461875886
169706	LUMINAIRES	80	3125461697068	New	187526	ACCESSORIES	78	3125461875268		187589	ACCESSORIES	43	3125461875893
169723	LUMINAIRES	121	3125461697235	New	187527	ACCESSORIES	78	3125461875275		187590	ACCESSORIES	213	3125461875909
174110	SOURCES	44	3125461741105		187528	ACCESSORIES	78	3125461875282		187591	ACCESSORIES	213	3125461875916
174111	SOURCES	44	3125461741112		187529	ACCESSORIES	78	3125461875299		187596	ACCESSORIES	43	3125461875961
174112	SOURCES	48	3125461741129		187531	ACCESSORIES	130	3125461875312		187597	ACCESSORIES	43	3125461875978
174114	SOURCES	67	3125461741143		187532	ACCESSORIES	133	3125461875329		187598	ACCESSORIES	133	3125461875985
174115	SOURCES	67	3125461741150		187533	ACCESSORIES	131	3125461875336		187599	ACCESSORIES	70	3125461875992
174116	SOURCES	67	3125461741167		187534	ACCESSORIES	130	3125461875343		187610	ACCESSORIES	82	3125461876104
174117	SOURCES	56	3125461741174		187535	ACCESSORIES	130	3125461875350		187612	ACCESSORIES	83	3125461876128
174118	SOURCES	56	3125461741181		187536	ACCESSORIES	131	3125461875367		187613	ACCESSORIES	83	3125461876135
174119	SOURCES	56	3125461741198		187537	ACCESSORIES	130	3125461875374		187614	ACCESSORIES	83	3125461876142
174121	SOURCES	70	3125461741211		187538	ACCESSORIES	130	3125461875381		187615	ACCESSORIES	83	3125461876159
174125	SOURCES	48	3125461741259	New	187539	ACCESSORIES	131	3125461875398		187616	ACCESSORIES	83	3125461876166
174126	SOURCES	46	3125461741266	New	187540	ACCESSORIES	92	3125461875404		187617	ACCESSORIES	83	3125461876173
174127	SOURCES	46	3125461741273	New	187541	ACCESSORIES	92	3125461875411		189601	ACCESSORIES	130	3125461896010
174128	SOURCES	46	3125461741280	New	187542	ACCESSORIES	92	3125461875428		189604	ACCESSORIES	131	3125461896041
174130	ACCESSORIES	35	3125461741303		187543	ACCESSORIES	97	3125461875435		189605	ACCESSORIES	131	3125461896058
174135	LUMINAIRES	179	3125461741358		187544	ACCESSORIES	97	3125461875442		189607	ACCESSORIES	131	3125461896072
174140	SOURCES	46	3125461741402		187546	ACCESSORIES	96	3125461875466		189608	ACCESSORIES	131	3125461896089
174141	SOURCES	46	3125461741419		187547	ACCESSORIES	95	3125461875473		189609	ACCESSORIES	131	3125461896096
174150	ACCESSORIES	22	3125461741501		187548	ACCESSORIES	95	3125461875480		189610	ACCESSORIES	133	3125461896102
174151	ACCESSORIES	22	3125461741518		187549	ACCESSORIES	95	3125461875497		189614	ACCESSORIES	133	3125461896140
174152	ACCESSORIES	23	3125461741525		187550	ACCESSORIES	97	3125461875503		189617	ACCESSORIES	133	3125461896171
174153	ACCESSORIES	23	3125461741532		187551	ACCESSORIES	97	3125461875510		189623	ACCESSORIES	131	3125461896232
174154	ACCESSORIES	23	3125461741549		187552	ACCESSORIES	95	3125461875527		189624	ACCESSORIES	130	3125461896249
174155	ACCESSORIES	24	3125461741556		187553	ACCESSORIES	97	3125461875534		189625	ACCESSORIES	131	3125461896256
174156	ACCESSORIES	24	3125461741563		187554	ACCESSORIES	92	3125461875541		189626	ACCESSORIES	131	3125461896263
174160	ACCESSORIES	64	3125461741600		187557	ACCESSORIES	58	3125461875572		189627	ACCESSORIES	131	3125461896270

Ref.	CATALOG	PAGE	EAN
189629	ACCESSORIES	131	3125461896294
189631	ACCESSORIES	130	3125461896317
189632	ACCESSORIES	131	3125461896324
189633	ACCESSORIES	131	3125461896331
189634	ACCESSORIES	131	3125461896348
189636	ACCESSORIES	133	3125461896362
189637	ACCESSORIES	131	3125461896379
189638	ACCESSORIES	131	3125461896386
189639	ACCESSORIES	131	3125461896393
189640	ACCESSORIES	131	3125461896409
189643	ACCESSORIES	131	3125461896430
189650	ACCESSORIES	133	3125461896508
189651	ACCESSORIES	133	3125461896515
200106	ACCESSORIES	230	3125462001062
200107	ACCESSORIES	230	3125462001079
200108	ACCESSORIES	230	3125462001086
200109	ACCESSORIES	230	3125462001093
200110	ACCESSORIES	230	3125462001109
200112	ACCESSORIES	230	3125462001123
200118	ACCESSORIES	230	3125462001185
200121	ACCESSORIES	230	3125462001215
200143	ACCESSORIES	231	3125462001437
200145	ACCESSORIES	231	3125462001451
200148	ACCESSORIES	231	3125462001482
200151	ACCESSORIES	231	3125462001512
200153	ACCESSORIES	231	3125462001536
200216	ACCESSORIES	231	3125462002168
200237	ACCESSORIES	231	3125462002373
200248	ACCESSORIES	231	3125462002489
200249	ACCESSORIES	231	3125462002496
200250	ACCESSORIES	231	3125462002502
200345	ACCESSORIES	231	3125462003455
200347	ACCESSORIES	231	3125462003479
200348	ACCESSORIES	231	3125462003486
200349	ACCESSORIES	231	3125462003493
200350	ACCESSORIES	231	3125462003509
200600	ACCESSORIES	169	3125462006005
200601	ACCESSORIES	169	3125462006012
200602	ACCESSORIES	169	3125462006029
200603	ACCESSORIES	169	3125462006036
200604	ACCESSORIES	168	3125462006043
200605	ACCESSORIES	168	3125462006050
200606	ACCESSORIES	168	3125462006067
200607	ACCESSORIES	168	3125462006074
200700	ACCESSORIES	69	3125462007002
200800	ACCESSORIES	31	3125462008009
200801	ACCESSORIES	31	3125462008016
200802	ACCESSORIES	31	3125462008023
200900	ACCESSORIES	60	3125462009006

New

New

Ref.	CATALOG	PAGE	EAN
200901	ACCESSORIES	60	3125462009013
201047	ACCESSORIES	232	3125462010477
201059	ACCESSORIES	232	3125462010590
201062	ACCESSORIES	232	3125462010620
201072	ACCESSORIES	232	3125462010729
201084	ACCESSORIES	232	3125462010842
201096	ACCESSORIES	232	3125462010965
202017	ACCESSORIES	231	3125462020179
202019	ACCESSORIES	231	3125462020193
202041	ACCESSORIES	230	3125462020414
202052	ACCESSORIES	231	3125462020520
202074	ACCESSORIES	231	3125462020742
202246	ACCESSORIES	231	3125462022463
202259	ACCESSORIES	231	3125462022593
204633	ACCESSORIES	236	3125462046339
204637	ACCESSORIES	236	3125462046377
204638	ACCESSORIES	236	3125462046384
204639	ACCESSORIES	236	3125462046391
205727	ACCESSORIES	235	3125462057274
205743	ACCESSORIES	235	3125462057434
206850	ACCESSORIES	235	3125462068508
206877	ACCESSORIES	235	3125462068775
206893	ACCESSORIES	235	3125462068935
210206	ACCESSORIES	116	3125462102066
210215	ACCESSORIES	116	3125462102158
210221	ACCESSORIES	116	3125462102219
210226	ACCESSORIES	116	3125462102264
210229	ACCESSORIES	116	3125462102295
210247	ACCESSORIES	117	3125462102479
210258	ACCESSORIES	116	3125462102585
210298	ACCESSORIES	117	3125462102981
210385	ACCESSORIES	117	3125462103858
210571	ACCESSORIES	120	3125462105715
210596	ACCESSORIES	114	3125462105968
210597	ACCESSORIES	114	3125462105975
210598	ACCESSORIES	114	3125462105982
210599	ACCESSORIES	114	3125462105999
210853	ACCESSORIES	125	3125462108532
210879	ACCESSORIES	112	3125462108792
210883	ACCESSORIES	99	3125462108839
210884	ACCESSORIES	99	3125462108846
210888	ACCESSORIES	112	3125462108884
210889	ACCESSORIES	112	3125462108891
210979	ACCESSORIES	113	3125462109799
210988	ACCESSORIES	113	3125462109881
210989	ACCESSORIES	113	3125462109898
213051	ACCESSORIES	106	3125462130519
213053	ACCESSORIES	106	3125462130533
213057	ACCESSORIES	106	3125462130571

Ref.	CATALOG	PAGE	EAN
213151	ACCESSORIES	106	3125462131516
213153	ACCESSORIES	106	3125462131530
213157	ACCESSORIES	106	3125462131578
213291	ACCESSORIES	106	3125462132919
213293	ACCESSORIES	106	3125462132933
213297	ACCESSORIES	106	3125462132971
213361	ACCESSORIES	108	3125462133619
213363	ACCESSORIES	108	3125462133633
213501	ACCESSORIES	107	3125462135019
214421	ACCESSORIES	113	3125462144219
214423	ACCESSORIES	113	3125462144233
214427	ACCESSORIES	113	3125462144271
214444	ACCESSORIES	113	3125462144448
214451	ACCESSORIES	113	3125462144516
214453	ACCESSORIES	113	3125462144530
214457	ACCESSORIES	113	3125462144578
214513	ACCESSORIES	109	3125462145131
214514	ACCESSORIES	108	3125462145148
214534	ACCESSORIES	108	3125462145346
214563	ACCESSORIES	109	3125462145636
215163	ACCESSORIES	110	3125462151637
215273	ACCESSORIES	109	3125462152733
216091	ACCESSORIES	104	3125462160912
216171	ACCESSORIES	104	3125462161711
216173	ACCESSORIES	110	3125462161735
216251	ACCESSORIES	103	3125462162510
216351	ACCESSORIES	102	3125462163517
216353	ACCESSORIES	102	3125462163531
216357	ACCESSORIES	102	3125462163579
216451	ACCESSORIES	103	3125462164514
216457	ACCESSORIES	103	3125462164576
216551	ACCESSORIES	102	3125462165511
216553	ACCESSORIES	102	3125462165535
216557	ACCESSORIES	102	3125462165573
216651	ACCESSORIES	102	3125462166518
216653	ACCESSORIES	102	3125462166532
216657	ACCESSORIES	102	3125462166570
216751	ACCESSORIES	103	3125462167515
218401	ACCESSORIES	113	3125462184017
218403	ACCESSORIES	113	3125462184031
218407	ACCESSORIES	113	3125462184079
218421	ACCESSORIES	113	3125462184215
218423	ACCESSORIES	113	3125462184239
218427	ACCESSORIES	113	3125462184277
218433	ACCESSORIES	113	3125462184338
219323	ACCESSORIES	104	3125462193231
219331	ACCESSORIES	99	3125462193316
219351	ACCESSORIES	104	3125462193514
220879	ACCESSORIES	112	3125462208799

Summary of references

Ref.	CATALOG	PAGE	EAN
220881	ACCESSORIES	112	3125462208812
220883	ACCESSORIES	97	3125462208836
220884	ACCESSORIES	97	3125462208843
220888	ACCESSORIES	112	3125462208881
220889	ACCESSORIES	112	3125462208898
220960	ACCESSORIES	110	3125462209604
220969	ACCESSORIES	112	3125462209697
220979	ACCESSORIES	113	3125462209796
220981	ACCESSORIES	113	3125462209819
220988	ACCESSORIES	113	3125462209888
220989	ACCESSORIES	113	3125462209895
221014	ACCESSORIES	123	3125462210143
221123	ACCESSORIES	122	3125462211232
221246	ACCESSORIES	122	3125462212468
221343	ACCESSORIES	123	3125462213434
221681	ACCESSORIES	110	3125462216817
221860	ACCESSORIES	122	3125462218606
230133	ACCESSORIES	199	3125462301339
230313	ACCESSORIES	199	3125462303135
230349	ACCESSORIES	199	3125462303494
230461	ACCESSORIES	199	3125462304613
230573	ACCESSORIES	199	3125462305733
230591	ACCESSORIES	199	3125462305917
230603	ACCESSORIES	200	3125462306037
230611	ACCESSORIES	200	3125462306112
230613	ACCESSORIES	200	3125462306136
230619	ACCESSORIES	200	3125462306198
230723	ACCESSORIES	200	3125462307232
230731	ACCESSORIES	200	3125462307317
230991	ACCESSORIES	200	3125462309915
231003	ACCESSORIES	201	3125462310034
231011	ACCESSORIES	201	3125462310119
231029	ACCESSORIES	201	3125462310294
231129	ACCESSORIES	201	3125462311291
231139	ACCESSORIES	201	3125462311390
231159	ACCESSORIES	201	3125462311598
231494	ACCESSORIES	202	3125462314940
231507	ACCESSORIES	202	3125462315077
231614	ACCESSORIES	202	3125462316142
231627	ACCESSORIES	202	3125462316272
231637	ACCESSORIES	202	3125462316371
231734	ACCESSORIES	203	3125462317347
231747	ACCESSORIES	203	3125462317477
231856	ACCESSORIES	204	3125462318566
231869	ACCESSORIES	204	3125462318696
231905	ACCESSORIES	180	3125462319051
232561	ACCESSORIES	204	3125462325618
232584	ACCESSORIES	205	3125462325847
232604	ACCESSORIES	205	3125462326042

Ref.	CATALOG	PAGE	EAN
232609	ACCESSORIES	205	3125462326097
232612	ACCESSORIES	205	3125462326127
232617	ACCESSORIES	205	3125462326172
232619	ACCESSORIES	205	3125462326196
232763	ACCESSORIES	198	3125462327636
232771	ACCESSORIES	198	3125462327711
232803	ACCESSORIES	198	3125462328039
232821	ACCESSORIES	198	3125462328213
232837	ACCESSORIES	198	3125462328374
232901	ACCESSORIES	198	3125462329012
232911	ACCESSORIES	198	3125462329111
232953	ACCESSORIES	203	3125462329531
233353	ACCESSORIES	114	3125462333538
233367	ACCESSORIES	114	3125462333675
233469	ACCESSORIES	206	3125462334696
233479	ACCESSORIES	206	3125462334795
233481	ACCESSORIES	206	3125462334818
233492	ACCESSORIES	206	3125462334924
233502	ACCESSORIES	208	3125462335020
233503	ACCESSORIES	208	3125462335037
233505	ACCESSORIES	208	3125462335051
233519	ACCESSORIES	207	3125462335198
233538	ACCESSORIES	206	3125462335389
233542	ACCESSORIES	206	3125462335426
233705	ACCESSORIES	208	3125462337055
233709	ACCESSORIES	208	3125462337093
233717	ACCESSORIES	208	3125462337178
233731	ACCESSORIES	209	3125462337314
235011	ACCESSORIES	137	3125462350115
235017	ACCESSORIES	137	3125462350177
235025	ACCESSORIES	137	3125462350252
235147	ACCESSORIES	137	3125462351471
235753	ACCESSORIES	139	3125462357534
235833	ACCESSORIES	138	3125462358333
235841	ACCESSORIES	138	3125462358418
235913	ACCESSORIES	138	3125462359132
235921	ACCESSORIES	138	3125462359217
235927	ACCESSORIES	138	3125462359279
236243	ACCESSORIES	137	3125462362439
236251	ACCESSORIES	137	3125462362514
236257	ACCESSORIES	137	3125462362576
236285	ACCESSORIES	137	3125462362859
236373	ACCESSORIES	138	3125462363733
236381	ACCESSORIES	138	3125462363818
236387	ACCESSORIES	138	3125462363870
236398	ACCESSORIES	138	3125462363986
236527	ACCESSORIES	139	3125462365270
236974	ACCESSORIES	140	3125462369742
236982	ACCESSORIES	139	3125462369827

Ref.	CATALOG	PAGE	EAN
237043	ACCESSORIES	135	3125462370434
237051	ACCESSORIES	135	3125462370519
237062	ACCESSORIES	135	3125462370625
237077	ACCESSORIES	135	3125462370779
237079	ACCESSORIES	135	3125462370793
237094	ACCESSORIES	135	3125462370946
237133	ACCESSORIES	136	3125462371332
237141	ACCESSORIES	136	3125462371417
237142	ACCESSORIES	136	3125462371424
237147	ACCESSORIES	136	3125462371479
237149	ACCESSORIES	136	3125462371493
237331	ACCESSORIES	136	3125462373312
237457	ACCESSORIES	136	3125462374579
237571	ACCESSORIES	134	3125462375712
237577	ACCESSORIES	134	3125462375774
237712	ACCESSORIES	134	3125462377129
237881	ACCESSORIES	134	3125462378812
237886	ACCESSORIES	134	3125462378867
237893	ACCESSORIES	134	3125462378935
237894	ACCESSORIES	134	3125462378942
237895	ACCESSORIES	134	3125462378959
237941	ACCESSORIES	135	3125462379413
237942	ACCESSORIES	135	3125462379420
237943	ACCESSORIES	135	3125462379437
237944	ACCESSORIES	135	3125462379444
237947	ACCESSORIES	135	3125462379475
237949	ACCESSORIES	135	3125462379499
240511	ACCESSORIES	145	3125462405112
240523	ACCESSORIES	144	3125462405235
240531	ACCESSORIES	144	3125462405310
240540	ACCESSORIES	144	3125462405402
240547	ACCESSORIES	144	3125462405471
240573	ACCESSORIES	145	3125462405730
240580	ACCESSORIES	145	3125462405808
240581	ACCESSORIES	145	3125462405815
240587	ACCESSORIES	145	3125462405877
241001	ACCESSORIES	144	3125462410017
241023	ACCESSORIES	144	3125462410239
241040	ACCESSORIES	144	3125462410406
241041	ACCESSORIES	144	3125462410413
241313	ACCESSORIES	147	3125462413131
241321	ACCESSORIES	147	3125462413216
241350	ACCESSORIES	147	3125462413506
241451	ACCESSORIES	147	3125462414510
241467	ACCESSORIES	147	3125462414671
241471	ACCESSORIES	147	3125462414718
241563	ACCESSORIES	146	3125462415630
241581	ACCESSORIES	146	3125462415814
241604	ACCESSORIES	63	3125462416040

Ref.	CATALOG	PAGE	EAN
241605	ACCESSORIES	63	3125462416057
241606	ACCESSORIES	58	3125462416064
241607	ACCESSORIES	57	3125462416071
241608	ACCESSORIES	57	3125462416088
241611	ACCESSORIES	148	3125462416118
241631	ACCESSORIES	146	3125462416316
241633	ACCESSORIES	148	3125462416330
241634	ACCESSORIES	148	3125462416347
241635	ACCESSORIES	148	3125462416354
241636	ACCESSORIES	148	3125462416361
241638	ACCESSORIES	148	3125462416385
241639	ACCESSORIES	148	3125462416392
241851	ACCESSORIES	66	3125462418518
241853	ACCESSORIES	66	3125462418532
241857	ACCESSORIES	66	3125462418570
241879	ACCESSORIES	66	3125462418792
241880	ACCESSORIES	66	3125462418808
241962	ACCESSORIES	86	3125462419621
241974	ACCESSORIES	86	3125462419744
241975	ACCESSORIES	86	3125462419751
241983	ACCESSORIES	86	3125462419836
241993	ACCESSORIES	86	3125462419935
245115	ACCESSORIES	158	3125462451157
245209	ACCESSORIES	158	3125462452093
245443	ACCESSORIES	158	3125462454431
245457	ACCESSORIES	158	3125462454578
245465	ACCESSORIES	158	3125462454653
245695	ACCESSORIES	158	3125462456954
245795	ACCESSORIES	161	3125462457951
245801	ACCESSORIES	159	3125462458019
245803	ACCESSORIES	159	3125462458033
245821	ACCESSORIES	159	3125462458217
245823	ACCESSORIES	159	3125462458231
245824	ACCESSORIES	159	3125462458248
246051	ACCESSORIES	160	3125462460517
246063	ACCESSORIES	160	3125462460630
246077	ACCESSORIES	160	3125462460777
246088	ACCESSORIES	160	3125462460883
246751	ACCESSORIES	157	3125462467516
246763	ACCESSORIES	157	3125462467639
246941	ACCESSORIES	158	3125462469411
246953	ACCESSORIES	158	3125462469534
247325	ACCESSORIES	161	3125462473258
247763	ACCESSORIES	161	3125462477638
250554	ACCESSORIES	152	3125462505546
250555	ACCESSORIES	152	3125462505553
250556	ACCESSORIES	152	3125462505560
250557	ACCESSORIES	152	3125462505577
250781	ACCESSORIES	152	3125462507816

New
New

Ref.	CATALOG	PAGE	EAN
250784	ACCESSORIES	153	3125462507847
250785	ACCESSORIES	153	3125462507854
250786	ACCESSORIES	152	3125462507861
250787	ACCESSORIES	153	3125462507878
250788	ACCESSORIES	153	3125462507885
250887	ACCESSORIES	152	3125462508875
250891	ACCESSORIES	152	3125462508912
250893	ACCESSORIES	152	3125462508936
250897	ACCESSORIES	152	3125462508974
252111	ACCESSORIES	171	3125462521119
253003	ACCESSORIES	125	3125462530036
253013	ACCESSORIES	125	3125462530135
260001	ACCESSORIES	164	3125462600012
260002	ACCESSORIES	164	3125462600029
260003	ACCESSORIES	164	3125462600036
260007	ACCESSORIES	164	3125462600074
260011	ACCESSORIES	149	3125462600111
260035	ACCESSORIES	124	3125462600357
260049	ACCESSORIES	124	3125462600494
260050	ACCESSORIES	123	3125462600500
260056	ACCESSORIES	124	3125462600562
260067	ACCESSORIES	125	3125462600678
260078	ACCESSORIES	125	3125462600784
260120	ACCESSORIES	209	3125462601200
260721	ACCESSORIES	165	3125462607219
260723	ACCESSORIES	165	3125462607233
260727	ACCESSORIES	165	3125462607271
260821	ACCESSORIES	165	3125462608216
261122	ACCESSORIES	149	3125462611223
261133	ACCESSORIES	149	3125462611339
261137	ACCESSORIES	149	3125462611377
262015	ACCESSORIES	121	3125462620157
262046	ACCESSORIES	121	3125462620461
262048	ACCESSORIES	121	3125462620485
262049	ACCESSORIES	120	3125462620492
262100	ACCESSORIES	118	3125462621000
262171	ACCESSORIES	118	3125462621710
262180	ACCESSORIES	118	3125462621802
262185	ACCESSORIES	118	3125462621857
266015	LUMINAIRES	114	3125462660153
269146	ACCESSORIES	119	3125462691461
269147	ACCESSORIES	119	3125462691478
269148	ACCESSORIES	119	3125462691485
269150	ACCESSORIES	119	3125462691508
269168	ACCESSORIES	120	3125462691683
269176	SOURCES	40	3125462691768
269324	ACCESSORIES	119	3125462693243
281492	ACCESSORIES	174	3125462814921
281836	ACCESSORIES	174	3125462818363

Ref.	CATALOG	PAGE	EAN
282027	ACCESSORIES	174	3125462820274
282039	ACCESSORIES	174	3125462820397
282049	ACCESSORIES	174	3125462820496
282171	ACCESSORIES	174	3125462821714
282852	ACCESSORIES	87	3125462828522
282963	ACCESSORIES	87	3125462829635
283884	ACCESSORIES	87	3125462838842
283895	ACCESSORIES	87	3125462838958
285664	ACCESSORIES	175	3125462856648
286230	ACCESSORIES	175	3125462862304
287372	ACCESSORIES	176	3125462873720
287594	ACCESSORIES	176	3125462875946
287605	ACCESSORIES	176	3125462876059
288272	ACCESSORIES	176	3125462882722
288525	ACCESSORIES	216	3125462885259
288636	ACCESSORIES	216	3125462886362
288760	ACCESSORIES	216	3125462887604
288869	ACCESSORIES	216	3125462888694
289204	ACCESSORIES	217	3125462892042
289205	ACCESSORIES	217	3125462892059
289206	ACCESSORIES	217	3125462892066
289658	ACCESSORIES	216	3125462896583
290615	ACCESSORIES	217	3125462906152
300101	ACCESSORIES	92	3125463001016
300102	ACCESSORIES	92	3125463001023
300200	ACCESSORIES	51	3125463002006
300210	ACCESSORIES	51	3125463002105
300211	ACCESSORIES	51	3125463002112
300220	ACCESSORIES	51	3125463002204
300221	ACCESSORIES	51	3125463002211
300250	ACCESSORIES	50	3125463002501
300251	ACCESSORIES	50	3125463002518
300300	ACCESSORIES	74	3125463003003
300301	ACCESSORIES	74	3125463003010
300351	ACCESSORIES	76	3125463003515
300352	ACCESSORIES	76	3125463003522
300353	ACCESSORIES	76	3125463003539
300354	ACCESSORIES	76	3125463003546
300356	ACCESSORIES	76	3125463003560
300357	ACCESSORIES	76	3125463003577
300369	ACCESSORIES	178	3125463003690
300370	ACCESSORIES	178	3125463003706
300382	ACCESSORIES	178	3125463003829
300410	ACCESSORIES	62	3125463004109
300453	ACCESSORIES	36	3125463004536
300454	ACCESSORIES	36	3125463004543
300456	ACCESSORIES	36	3125463004567
300475	ACCESSORIES	27	3125463004758
300503	ACCESSORIES	45	3125463005038

Summary of references

Ref.	CATALOG	PAGE	EAN
300504	ACCESSORIES	45	3125463005045
300600	ACCESSORIES	96	3125463006004
300601	ACCESSORIES	96	3125463006011
300602	ACCESSORIES	96	3125463006028
300604	ACCESSORIES	96	3125463006042
300611	ACCESSORIES	95	3125463006110
300612	ACCESSORIES	95	3125463006127
300613	ACCESSORIES	95	3125463006134
300614	ACCESSORIES	95	3125463006141
300616	ACCESSORIES	95	3125463006165
300621	ACCESSORIES	95	3125463006219
300622	ACCESSORIES	95	3125463006226
300623	ACCESSORIES	95	3125463006233
300624	ACCESSORIES	95	3125463006240
300626	ACCESSORIES	95	3125463006264
300627	ACCESSORIES	95	3125463006271
300628	ACCESSORIES	90	3125463006288
300629	ACCESSORIES	90	3125463006295
300630	ACCESSORIES	90	3125463006301
300702	ACCESSORIES	76	3125463007025
300703	ACCESSORIES	76	3125463007032
300704	ACCESSORIES	76	3125463007049
300705	ACCESSORIES	76	3125463007056
300706	ACCESSORIES	74	3125463007063
300800	ACCESSORIES	42	3125463008008
300802	ACCESSORIES	42	3125463008022
300803	ACCESSORIES	42	3125463008039
300804	ACCESSORIES	42	3125463008046
300825	ACCESSORIES	177	3125463008251
300903	ACCESSORIES	42	3125463009036
301001	ACCESSORIES	42	3125463010018
302001	ACCESSORIES	130	3125463020017
302104	ACCESSORIES	131	3125463021045
302105	ACCESSORIES	131	3125463021052
302106	ACCESSORIES	131	3125463021069
302107	ACCESSORIES	131	3125463021076
302195	ACCESSORIES	177	3125463021953
302201	ACCESSORIES	130	3125463022011
302202	ACCESSORIES	130	3125463022028
302203	ACCESSORIES	130	3125463022035
302204	ACCESSORIES	130	3125463022042
302257	ACCESSORIES	179	3125463022578
302279	ACCESSORIES	179	3125463022790
302281	ACCESSORIES	179	3125463022813
302292	ACCESSORIES	179	3125463022929
302303	ACCESSORIES	179	3125463023032
302314	ACCESSORIES	179	3125463023148
302325	ACCESSORIES	179	3125463023254
302336	ACCESSORIES	179	3125463023360

New

New

New

New

Ref.	CATALOG	PAGE	EAN
302347	ACCESSORIES	179	3125463023476
302448	ACCESSORIES	179	3125463024480
302460	ACCESSORIES	179	3125463024602
302471	ACCESSORIES	179	3125463024718
302482	ACCESSORIES	179	3125463024824
302493	ACCESSORIES	179	3125463024930
302537	ACCESSORIES	179	3125463025371
302548	ACCESSORIES	179	3125463025487
302551	ACCESSORIES	179	3125463025517
302554	ACCESSORIES	179	3125463025548
302598	ACCESSORIES	179	3125463025982
302643	ACCESSORIES	179	3125463026439
303121	ACCESSORIES	180	3125463031211
303598	ACCESSORIES	180	3125463035981
303619	ACCESSORIES	180	3125463036193
303620	ACCESSORIES	180	3125463036209
303675	ACCESSORIES	180	3125463036759
303731	ACCESSORIES	182	3125463037312
303842	ACCESSORIES	182	3125463038425
304126	ACCESSORIES	183	3125463041265
304237	ACCESSORIES	183	3125463042378
304561	ACCESSORIES	183	3125463045614
304783	ACCESSORIES	183	3125463047830
304894	ACCESSORIES	183	3125463048943
304905	ACCESSORIES	183	3125463049056
304916	ACCESSORIES	183	3125463049162
304927	ACCESSORIES	183	3125463049278
304938	ACCESSORIES	183	3125463049384
305001	ACCESSORIES	46	3125463050014
305002	ACCESSORIES	46	3125463050021
305421	ACCESSORIES	184	3125463054210
305467	ACCESSORIES	184	3125463054678
305478	ACCESSORIES	184	3125463054784
305590	ACCESSORIES	184	3125463055903
305944	ACCESSORIES	184	3125463059444
306340	ACCESSORIES	184	3125463063403
306351	ACCESSORIES	185	3125463063519
306359	ACCESSORIES	184	3125463063595
306362	ACCESSORIES	185	3125463063625
306473	ACCESSORIES	185	3125463064738
306574	ACCESSORIES	184	3125463065742
306796	ACCESSORIES	185	3125463067968
306929	ACCESSORIES	185	3125463069290
306930	ACCESSORIES	185	3125463069306
307002	ACCESSORIES	186	3125463070029
307013	ACCESSORIES	186	3125463070135
307124	ACCESSORIES	186	3125463071248
307346	ACCESSORIES	186	3125463073464
307350	ACCESSORIES	186	3125463073501

Ref.	CATALOG	PAGE	EAN
307902	ACCESSORIES	186	3125463079022
308136	ACCESSORIES	186	3125463081360
308147	ACCESSORIES	186	3125463081476
308470	ACCESSORIES	187	3125463084705
308482	ACCESSORIES	187	3125463084828
308692	ACCESSORIES	187	3125463086921
308702	ACCESSORIES	187	3125463087027
308713	ACCESSORIES	187	3125463087133
309007	ACCESSORIES	187	3125463090072
309420	ACCESSORIES	188	3125463094209
309431	ACCESSORIES	188	3125463094315
309442	ACCESSORIES	188	3125463094421
309453	ACCESSORIES	188	3125463094537
309464	ACCESSORIES	188	3125463094643
309475	ACCESSORIES	188	3125463094759
309486	ACCESSORIES	188	3125463094865
309497	ACCESSORIES	188	3125463094971
309509	ACCESSORIES	188	3125463095091
309610	ACCESSORIES	181	3125463096104
309721	ACCESSORIES	181	3125463097217
309732	ACCESSORIES	181	3125463097323
309765	ACCESSORIES	181	3125463097651
310001	ACCESSORIES	83	3125463100016
310002	ACCESSORIES	83	3125463100023
310004	ACCESSORIES	83	3125463100047
310005	ACCESSORIES	83	3125463100054
310012	ACCESSORIES	190	3125463100122
310034	ACCESSORIES	190	3125463100344
310078	ACCESSORIES	190	3125463100788
310089	ACCESSORIES	190	3125463100894
310127	ACCESSORIES	189	3125463101273
320000	ACCESSORIES	170	3125463200006
320001	ACCESSORIES	170	3125463200013
320486	ACCESSORIES	190	3125463204868
320596	ACCESSORIES	191	3125463205964
320719	ACCESSORIES	191	3125463207197
321626	ACCESSORIES	191	3125463216267
330215	ACCESSORIES	192	3125463302151
330237	ACCESSORIES	192	3125463302373
330359	ACCESSORIES	192	3125463303592
330573	ACCESSORIES	192	3125463305732
330697	ACCESSORIES	192	3125463306975
330719	ACCESSORIES	192	3125463307194
331728	ACCESSORIES	181	3125463317285
331840	ACCESSORIES	182	3125463318404
331951	ACCESSORIES	182	3125463319517
331972	ACCESSORIES	180	3125463319722
333000	ACCESSORIES	38	3125463330000
333003	ACCESSORIES	32	3125463330031

Ref.	CATALOG	PAGE	EAN
335715	ACCESSORIES	193	3125463357151
335726	ACCESSORIES	193	3125463357267
336501	ACCESSORIES	193	3125463365019
336674	ACCESSORIES	195	3125463366740
336785	ACCESSORIES	195	3125463367853
336907	ACCESSORIES	195	3125463369079
337009	ACCESSORIES	194	3125463370099
337010	ACCESSORIES	194	3125463370105
337020	ACCESSORIES	194	3125463370204
337034	ACCESSORIES	194	3125463370341
337132	ACCESSORIES	194	3125463371324
337724	ACCESSORIES	193	3125463377241
340017	ACCESSORIES	196	3125463400178
340039	ACCESSORIES	196	3125463400390
340051	ACCESSORIES	196	3125463400512
340073	ACCESSORIES	196	3125463400734
340095	ACCESSORIES	196	3125463400956
340137	ACCESSORIES	196	3125463401373
340159	ACCESSORIES	196	3125463401595
340171	ACCESSORIES	196	3125463401717
340193	ACCESSORIES	196	3125463401939
340215	ACCESSORIES	196	3125463402158
340237	ACCESSORIES	196	3125463402370
341012	ACCESSORIES	195	3125463410122
341056	ACCESSORIES	195	3125463410566
341190	ACCESSORIES	195	3125463411907
341212	ACCESSORIES	196	3125463412126
341234	ACCESSORIES	196	3125463412348
342020	ACCESSORIES	197	3125463420206
342142	ACCESSORIES	196	3125463421425
342164	ACCESSORIES	196	3125463421647
342186	ACCESSORIES	196	3125463421869
342208	ACCESSORIES	196	3125463422088
342230	ACCESSORIES	196	3125463422309
342252	ACCESSORIES	196	3125463422521
342274	ACCESSORIES	196	3125463422743
342296	ACCESSORIES	196	3125463422965
346425	ACCESSORIES	197	3125463464255
346436	ACCESSORIES	197	3125463464361
346447	ACCESSORIES	197	3125463464477
346458	ACCESSORIES	197	3125463464583
346469	ACCESSORIES	197	3125463464699
346470	ACCESSORIES	197	3125463464705
346481	ACCESSORIES	197	3125463464811
346492	ACCESSORIES	197	3125463464927
346513	ACCESSORIES	197	3125463465139
346524	ACCESSORIES	197	3125463465245
346546	ACCESSORIES	197	3125463465467
346568	ACCESSORIES	197	3125463465689

Ref.	CATALOG	PAGE	EAN
346580	ACCESSORIES	197	3125463465801
346591	ACCESSORIES	197	3125463465917
346602	ACCESSORIES	197	3125463466020
346613	ACCESSORIES	197	3125463466136
346635	ACCESSORIES	197	3125463466358
346657	ACCESSORIES	197	3125463466570
346914	ACCESSORIES	197	3125463469144
360301	ACCESSORIES	227	3125463603012
365063	ACCESSORIES	213	3125463650634
365074	ACCESSORIES	213	3125463650740
365085	ACCESSORIES	213	3125463650856
365096	ACCESSORIES	213	3125463650962
380507	ACCESSORIES	204	3125463805072
591010	SOURCES	166	3125465910101
700017	ACCESSORIES	214	3125467000176
700028	ACCESSORIES	214	3125467000282
700039	ACCESSORIES	214	3125467000398
700040	ACCESSORIES	214	3125467000404
700062	ACCESSORIES	214	3125467000626
700084	ACCESSORIES	214	3125467000848
700095	ACCESSORIES	214	3125467000954
700101	ACCESSORIES	215	3125467001012
700223	ACCESSORIES	215	3125467002231
700245	ACCESSORIES	215	3125467002453
700335	ACCESSORIES	215	3125467003351
700346	ACCESSORIES	215	3125467003467
700379	ACCESSORIES	215	3125467003795
700448	ACCESSORIES	227	3125467004488
700761	ACCESSORIES	227	3125467007618
700783	ACCESSORIES	227	3125467007830
703012	ACCESSORIES	218	3125467030128
703023	ACCESSORIES	218	3125467030234
703034	ACCESSORIES	218	3125467030340
703045	ACCESSORIES	218	3125467030456
703059	ACCESSORIES	218	3125467030593
703060	ACCESSORIES	218	3125467030609
703072	ACCESSORIES	218	3125467030722
703096	ACCESSORIES	219	3125467030968
703107	ACCESSORIES	219	3125467031071
703120	ACCESSORIES	219	3125467031200
703186	ACCESSORIES	219	3125467031866
703325	ACCESSORIES	219	3125467033259
703336	ACCESSORIES	219	3125467033365
705005	ACCESSORIES	220	3125467050058
705027	ACCESSORIES	220	3125467050270
705038	ACCESSORIES	220	3125467050386
705263	ACCESSORIES	222	3125467052632
705274	ACCESSORIES	222	3125467052748
705285	ACCESSORIES	222	3125467052854

Ref.	CATALOG	PAGE	EAN
705296	ACCESSORIES	222	3125467052960
706426	ACCESSORIES	222	3125467064260
710507	ACCESSORIES	226	3125467105079
710612	ACCESSORIES	222	3125467106120
711616	SOURCES	94	3125467116167
711617	SOURCES	94	3125467116174
711618	SOURCES	94	3125467116181
711619	SOURCES	94	3125467116198
711621	SOURCES	94	3125467116211
711894	SOURCES	78	3125467118949
712069	ACCESSORIES	221	3125467120690
713171	SOURCES	95	3125467131719
713172	SOURCES	95	3125467131726
713176	SOURCES	95	3125467131764
713177	SOURCES	95	3125467131771
713178	SOURCES	95	3125467131788
713179	SOURCES	95	3125467131795
713180	SOURCES	95	3125467131801
713196	SOURCES	91	3125467131962
713197	SOURCES	91	3125467131979
713199	SOURCES	93	3125467131993
713200	SOURCES	93	3125467132006
713201	SOURCES	93	3125467132013
713202	SOURCES	91	3125467132020
713209	SOURCES	93	3125467132099
713210	SOURCES	93	3125467132105
713297	SOURCES	93	3125467132976
713400	SOURCES	93	3125467134000
713475	ACCESSORIES	224	3125467134758
713488	ACCESSORIES	224	3125467134888
713496	SOURCES	91	3125467134963
713497	SOURCES	91	3125467134970
713501	SOURCES	91	3125467135014
713502	SOURCES	91	3125467135021
713503	SOURCES	91	3125467135038
713504	SOURCES	91	3125467135045
713508	SOURCES	91	3125467135083
713511	SOURCES	91	3125467135113
713512	SOURCES	91	3125467135120
713515	SOURCES	91	3125467135151
713517	ACCESSORIES	224	3125467135175
713620	SOURCES	92	3125467136202
713622	SOURCES	92	3125467136226
713626	SOURCES	92	3125467136264
713628	SOURCES	92	3125467136288
713771	SOURCES	92	3125467137711
713776	SOURCES	92	3125467137766
713777	SOURCES	92	3125467137773
713778	SOURCES	92	3125467137780

Summary of references

Ref.	CATALOG	PAGE	EAN
713779	SOURCES	92	3125467137797
713780	SOURCES	92	3125467137803
714663	ACCESSORIES	224	3125467146638
714696	ACCESSORIES	224	3125467146966
715168	ACCESSORIES	221	3125467151687
715981	SOURCES	98	3125467159812
715982	SOURCES	98	3125467159829
715984	SOURCES	99	3125467159843
715986	SOURCES	99	3125467159867
715987	SOURCES	99	3125467159874
715988	SOURCES	99	3125467159881
715990	SOURCES	98	3125467159904
715993	SOURCES	98	3125467159935
715994	SOURCES	98	3125467159942
715995	SOURCES	99	3125467159959
716600	SOURCES	99	3125467166001
716601	SOURCES	101	3125467166018
716602	SOURCES	101	3125467166025
716603	SOURCES	103	3125467166032
716604	SOURCES	101	3125467166049
716605	SOURCES	102	3125467166056
716606	SOURCES	102	3125467166063
716607	SOURCES	103	3125467166070
716613	SOURCES	101	3125467166131
716614	SOURCES	102	3125467166148
716615	SOURCES	102	3125467166155
716617	SOURCES	103	3125467166179
716619	SOURCES	101	3125467166193
716621	SOURCES	101	3125467166216
716622	SOURCES	101	3125467166223
716623	SOURCES	79	3125467166230
716624	SOURCES	79	3125467166247
716625	SOURCES	79	3125467166254
716626	SOURCES	79	3125467166261
716627	SOURCES	76	3125467166278
716628	SOURCES	143	3125467166285
716629	SOURCES	143	3125467166292
716630	SOURCES	102	3125467166308
716631	SOURCES	102	3125467166315
716632	SOURCES	102	3125467166322
716633	SOURCES	102	3125467166339
716635	SOURCES	102	3125467166353
716636	SOURCES	102	3125467166360
716642	SOURCES	102	3125467166421
716643	SOURCES	102	3125467166438
716651	SOURCES	94	3125467166513
716653	SOURCES	94	3125467166537
716660	SOURCES	104	3125467166605
716661	SOURCES	104	3125467166612

Ref.	CATALOG	PAGE	EAN
716662	SOURCES	104	3125467166629
716672	SOURCES	103	3125467166728
716676	SOURCES	101	3125467166766
716678	SOURCES	101	3125467166780
716681	SOURCES	104	3125467166810
716682	SOURCES	104	3125467166827
716683	SOURCES	104	3125467166834
716686	SOURCES	104	3125467166865
716689	SOURCES	104	3125467166896
716690	SOURCES	74	3125467166902
716692	SOURCES	101	3125467166926
716694	SOURCES	101	3125467166940
716695	SOURCES	79	3125467166957
716696	SOURCES	79	3125467166964
716697	SOURCES	79	3125467166971
716698	SOURCES	79	3125467166988
716699	SOURCES	76	3125467166995
716700	SOURCES	76	3125467167008
716703	SOURCES	74	3125467167039
716800	SOURCES	99	3125467168005
716801	SOURCES	99	3125467168012
716802	SOURCES	99	3125467168029
716803	SOURCES	99	3125467168036
716997	SOURCES	120	3125467169972
716998	SOURCES	120	3125467169989
716999	SOURCES	120	3125467169996
717001	SOURCES	84	3125467170015
717002	SOURCES	84	3125467170022
717004	SOURCES	87	3125467170046
719000	SOURCES	109	3125467190006
719001	SOURCES	109	3125467190013
719002	SOURCES	109	3125467190020
719004	SOURCES	110	3125467190044
719005	SOURCES	110	3125467190051
719006	SOURCES	109	3125467190068
719007	SOURCES	109	3125467190075
719008	SOURCES	110	3125467190082
719009	SOURCES	110	3125467190099
719010	SOURCES	110	3125467190105
719011	SOURCES	110	3125467190112
719012	SOURCES	109	3125467190129
719013	SOURCES	110	3125467190136
719014	SOURCES	52	3125467190143
719015	SOURCES	52	3125467190150
719016	SOURCES	51	3125467190167
719017	SOURCES	51	3125467190174
719030	SOURCES	54	3125467190303
719031	SOURCES	54	3125467190310
719032	SOURCES	54	3125467190327

Ref.	CATALOG	PAGE	EAN	
719033	SOURCES	54	3125467190334	
719034	SOURCES	47	3125467190341	
719035	SOURCES	47	3125467190358	
719036	SOURCES	48	3125467190365	
719037	SOURCES	47	3125467190372	
719038	SOURCES	47	3125467190389	
719039	SOURCES	52	3125467190396	
719040	SOURCES	48	3125467190402	
719041	SOURCES	63	3125467190419	
719042	SOURCES	141	3125467190426	
719043	SOURCES	141	3125467190433	
719044	SOURCES	141	3125467190440	
719045	SOURCES	67	3125467190457	New
719046	SOURCES	67	3125467190464	New
719047	SOURCES	67	3125467190471	New
719048	SOURCES	67	3125467190488	New
719049	SOURCES	46	3125467190495	New
719050	SOURCES	46	3125467190501	New
719051	SOURCES	43	3125467190518	New
719052	SOURCES	43	3125467190525	New
719053	SOURCES	55	3125467190532	New
719054	SOURCES	55	3125467190549	New
719055	SOURCES	55	3125467190556	New
719056	SOURCES	55	3125467190563	New
719200	SOURCES	51	3125467192000	New
719201	SOURCES	51	3125467192017	New
730367	ACCESSORIES	221	3125467303673	
730502	ACCESSORIES	221	3125467305028	
744342	ACCESSORIES	220	3125467443423	
744353	ACCESSORIES	220	3125467443539	
744495	ACCESSORIES	220	3125467444956	
744496	ACCESSORIES	220	3125467444963	
744518	ACCESSORIES	220	3125467445182	
744529	ACCESSORIES	220	3125467445298	
744603	ACCESSORIES	221	3125467446035	
744624	ACCESSORIES	221	3125467446240	
745367	ACCESSORIES	226	3125467453675	
745478	ACCESSORIES	226	3125467454788	
745480	ACCESSORIES	226	3125467454801	
745490	ACCESSORIES	226	3125467454900	
745498	ACCESSORIES	226	3125467454986	
745500	ACCESSORIES	226	3125467455006	
745501	ACCESSORIES	226	3125467455013	
893010	SOURCES	165	3125468930106	
893011	SOURCES	141	3125468930113	
913020	SOURCES	167	3125469130208	
976641	SOURCES	48	3125469766414	
976643	SOURCES	64	3125469766438	
976644	SOURCES	64	3125469766445	

Ref.	CATALOG	PAGE	EAN
976645	SOURCES	64	3125469766452
976646	SOURCES	68	3125469766469
976647	SOURCES	68	3125469766476
976648	SOURCES	64	3125469766483
976652	SOURCES	58	3125469766520
976653	SOURCES	59	3125469766537
976950	LUMINAIRES	176	3125469769507
976951	LUMINAIRES	176	3125469769514
976952	LUMINAIRES	176	3125469769521
976953	LUMINAIRES	176	3125469769538
976971	ACCESSORIES	35	3125469769712
997000	SOURCES	137	3125469970002
997001	SOURCES	137	3125469970019
997005	SOURCES	138	3125469970057
997009	SOURCES	138	3125469970095
997108	SOURCES	138	3125469971085
998052	SOURCES	164	3125469980520
998620	SOURCES	159	3125469986201
998622	SOURCES	159	3125469986225
998633	SOURCES	159	3125469986331
998635	SOURCES	162	3125469986355
998638	SOURCES	159	3125469986386
998639	SOURCES	159	3125469986393
998654	SOURCES	159	3125469986546
998655	SOURCES	159	3125469986553
998656	SOURCES	160	3125469986560
998659	SOURCES	160	3125469986591
998662	SOURCES	162	3125469986621
998665	SOURCES	161	3125469986652
998666	SOURCES	161	3125469986669
998667	SOURCES	158	3125469986676
998668	SOURCES	158	3125469986683
998670	SOURCES	160	3125469986706
998671	SOURCES	158	3125469986713
998672	SOURCES	158	3125469986720
998673	SOURCES	163	3125469986737
998674	SOURCES	162	3125469986744
998676	SOURCES	163	3125469986768
998682	SOURCES	158	3125469986829
998683	SOURCES	158	3125469986836
998686	SOURCES	160	3125469986867
998687	SOURCES	160	3125469986874
998695	SOURCES	158	3125469987017
998701	SOURCES	158	3125469987017
998709	SOURCES	159	3125469987093
998710	SOURCES	159	3125469987109
998712	SOURCES	159	3125469987123
998713	SOURCES	159	3125469987130
998750	SOURCES	163	3125469987505

Ref.	CATALOG	PAGE	EAN
998761	SOURCES	162	3125469987611
998762	SOURCES	162	3125469987628
998763	SOURCES	162	3125469987635
998765	SOURCES	161	3125469987659
998766	SOURCES	161	3125469987666
998767	SOURCES	161	3125469987673
998768	SOURCES	164	3125469987680
998769	SOURCES	164	3125469987697
998770	SOURCES	164	3125469987703
999990	SOURCES	71	3125469999904

130 | 1894
YEARS | **2024/25**
AT THE ORIGIN OF LIGHT.



GIRARD SUDRON
PARIS 1894

FR 47 rue des Tournelles | 75003 PARIS
+33 (0)1 44 59 22 20 | serviceclients@girard-sudron.com

CH In Courta Rama 2 | 1163 Etoy
+41 (0)22 369 95 00 | info@girard-sudron.ch